



DIRECT FASTENING TECHNOLOGY MANUAL 04/2022



Contents

Part 1: Direct fastening principles and technique	13
1. Introduction	13
1.1 Definitions and general terminology	13
1.2 Reasons for using direct fastening	13
1.3 Direct fastening applications	15
2. The direct fastening system	16
2.1 Fasteners	17
2.2 Manufacturing process	18
2.3 Fastener raw material	19
2.4 Types of Hilti direct fastening tools	20
2.5 Operating principles	22
3. Health and safety	25
3.1 Operator safety	25
3.2 Fastening safety	30
3.3 Quality of installation	31
4. Corrosion	33
4.1 Corrosion protection of direct fastening systems	33
4.2 Fastener selection	35
5. Steel base material	39
5.1 Anchoring mechanisms	39
5.2 Factors influencing pull-out resistance	41
5.3 Suitability of the steel for fastening	46
5.4 Application limit diagrams	47
5.5 Thin steel base material	48
5.6 Types of load and modes of failure	49
5.7 Effect of fasteners on structural steel	56
6. Concrete base material	61
6.1 Anchoring mechanisms	61
6.2 Factors influencing resistance to pull-out	63
6.3 Effect of time on pull-out resistance	66
6.4 Effect on concrete components	67
7. Masonry base material	68
7.1 General suitability	68

8. Temperature effects on the fastening	69
8.1 Effect of low temperatures on fasteners	69
8.2 Effect of low temperatures on fastenings to steel	70
8.3 Fire rating of fastenings to steel	72
8.4 Fire rating of fastenings to concrete	74
9. Design concepts	76
10. Determination of technical data for fastening design	78
10.1 Fastenings to steel	78
10.2 Profile sheet fastenings	79
10.3 Fastenings to concrete (standard DX / GX / BX)	80
10.4 DX fastenings to concrete (DX-Kwik)	82
10.5 Fastener design in the USA and Canada	83
Part 2: Fastener selection guide	85
1. Selecting the right fastener	86
1.1 Selection based on the type of concrete	87
1.2 Selection based on environmental conditions	94
2. Design concepts	96
3. Nomenclature/symbols	97
4. Tips for users	99
5. Nail and stud designation	105
Part 3: Accessories and consumables compatibility	111
Powder-actuated tools	111
DX 2 Semi-automatic powder-actuated tool for fastening single nails	113
DX 351 Powder-actuated tool for interior finishing applications	114
DX 351 F8 Powder-actuated tool for interior finishing, mechanical and electrical applications	114
DX 351 BT Powder-actuated tool for fastening X-BT threaded studs	115
DX 351 BTG Powder-actuated tool for fastening gratings	115
DX 351-CT Fully automatic powder-actuated tool for fastening ceiling fasteners to concrete or steel	115
DX 450 Powder-actuated tool – standard	116
DX 450-FA Powder-actuated tool – facade	116
DX 460-MX Powder-actuated tool for fastening collated nails	117
DX 460-F8 Powder-actuated tool for fastening single nails	117
DX 460-SM Powder-actuated tool for fastening metal decks	120
DX 5 MX Digitally enabled powder-actuated tool for fastening collated nails	121

DX 5 F8	Digitally enabled powder-actuated tool for fastening single nails	121
DX 5 IE	Powder-actuated tool for fastening insulation	124
DX 5 GR	Powder-actuated tool for fastening gratings	124
DX 5 SM	Powder-actuated tool for fastening metal decks	124
DX 5 F10	Powder-actuated tool for fastening W10 threaded studs	124
DX 6 MX	Digitally enabled powder-actuated tool for fastening collated nails	125
DX 6 F8	Digitally enabled powder-actuated tool for fastening single nails	126
DX 6 IE	Digitally enabled powder-actuated tool for fastening insulation	129
DX 6 GR	Digitally enabled powder-actuated tool for fastening grating	129
DX 6 F10	Digitally enabled powder-actuated tool	129
DX 76 PTR	Powder-actuated tool for fastening metal decks with collated nails	130
DX 76 PTR	Powder-actuated tool for fastening metal decks with single nails	130
DX 76 PTR	Powder-actuated tool for fastening metal decks on concrete – DX-Kwik	131
DX 76 PTR	Powder-actuated tool for fastening HVB shear connectors	131
DX 76 PTR	Powder-actuated tool for fastening gratings and checker plates	132
DX 76 PTR	Powder-actuated tool for fastening heavy duty applications	132
DX 76 MX	Powder-actuated tool for fastening metal decks with collated nails	133
DX 76	Powder-actuated tool for fastening metal decks with single nails	133
DX 76	Powder-actuated tool for fastening metal decks on concrete – DX-Kwik	134
DX 76	Powder-actuated tool for fastening HVB shear connectors	134
DX 76	Powder-actuated tool for fastening gratings and checker plates	135
DX 76	Powder-actuated tool for fastening heavy duty applications	135
DX-860-ENP	Powder-actuated tool for fastening metal decks	136
DX 860-HSN	Powder-actuated tool for fastening metal decks	136
DX 9-ENP	Digitally enabled powder-actuated tool for fastening metal decks	137
DX 9-HSN	Digitally enabled powder-actuated tool for fastening metal decks	137
Cartridges – Propellants for powder-actuated tools		138
Gas-actuated tools		139
GX 90 WF	Gas-actuated tool for wood framing	139
GX 120	Gas-actuated tool for interior finishing applications	140
GX 120-ME	Gas-actuated tool for mechanical and electrical applications	140
GX 3	Gas-actuated tool for interior finishing and building construction applications	141
GX 3-ME	Gas-actuated tool for mechanical and electrical applications	141
GX 2	Gas-actuated tool for interior finishing and building construction applications	142

Gas cans		142
Battery-actuated tools		143
BX 3-BT	Battery-actuated tool for multi-purpose and electrical connection applications	143
BX 3-BTG	Battery-actuated tool for fastening gratings	143
BX 3-IF	Battery-actuated tool for interior finishing and building construction applications	144
BX 3-ME	Battery-actuated tool for mechanical and electrical applications	144
BX 3 02	Battery-actuated tool for mechanical and electrical applications	145
BX 3-L 02	Battery-actuated tool for interior finishing, mechanical and electrical and building construction applications	145
Part 4: Fasteners		149
Siding and decking nails		151
X-ENP	Siding and decking nail	151
SDK2, PDK2	Sealing cap for cladding fastening	161
X-ENP2K	Siding and decking nail	163
X-HSN 24	Diaphragm decking nail	169
NPH	Siding and decking nail	173
Shear connectors		177
X-HVB	Shear connector	177
General purpose nails		185
X-X	Nail for fastening to concrete and steel	185
X-U	Nail for fastening to concrete and steel	199
X-P	Nail for fastening to concrete and steel	211
X-C	Nail for fastening to concrete and sand lime masonry	227
X-S	Nail for fastening drywall track to steel	233
DS	Heavy-duty nail for fastening to concrete and steel	237
EDS	Nail for fastening to steel	243
X-CR	Stainless steel nail for fastening to concrete, sand lime masonry and steel	265
X-CT	Nail for forming or other temporary use	273

Threaded studs		277
DX-Kwik – X-M6 H, X-M8 H and DNH, X-DKH Threaded studs and nails		277
X-M6, X-W6, X-M8, M10, W10 Threaded stud for fastening to concrete		283
X-EM6H, X-EW6H, X-EF7H, X-EM8H, X-EM10H, X-EW10H Threaded stud for fastening to steel		289
X-BT Stainless steel threaded stud		297
X-BT New Generation stainless steel threaded stud		303
X-BT-MF Composite threaded stud		313
X-BT-MR-N Stainless steel threaded stud for narrow through hole		321
S-BT Screw-in stainless steel and carbon steel threaded stud		329
X-ST-GR Stainless steel threaded stud for fastening to steel		343
X-CRM Stainless steel threaded stud for fastening to concrete and steel		347
X-BT-ER Stainless steel threaded stud for electrical connection		353
S-BT-ER, S-BT-EF Screw-in stainless steel and carbon steel threaded stud		359
Standoff adapters		373
Grating fastening system		387
X-FCM Grating fastening system		387
X-FCM-R HL Grating fastening system		401
X-FCM NG Grating fastening system		407
X-FCI-M Grating fastening system		421
X-GR Grating fastening system		431
X-FCS-R Grating element		441
X-PGR-RU Grating fastening system (pre-drilled)		453
X-MGR Grating fastening system		459
X-FCP Checker plate fastening system		463
Insulation fasteners		471
X-IE-G Insulation fastener		471
X-IE Insulation fastener		481
XI-FV ETICS Insulation fastener		491
X-SW Soft washer		495
X-SW Soft washer – Fastening drainage membrane to concrete		498
X-SW Soft washer – Fastening insulation to concrete		502

Form stop fasteners		507
X-FS	Form stop	507
X-FS	Form stop – Fastening formwork	510
X-DFS	Double form stop	513
Gas-actuated tool fastening system		517
X-EGN, X-GHP,		
X-GN	Fastener for gas-actuated tool	517
GX 3 System	Fastener for interior finishing, building construction, mechanical and electrical application	523
GX 2 System	Fastener for interior finishing application	533
Battery-actuated tool fastening system		537
BX 3 System	Fastener for interior finishing, building construction, mechanical and electrical application	537
Hanger fasteners		547
BX-Kwik	Electrical hanger system	547
X-HS and X-CC	Threaded hanger and loop hanger system	551
X-MW MX,		
X-MW ALH	Wire hanging system	559
X-EHS MX,		
X-ECC MX	Electrical hanger system	573
X-DHS MX	Pipe support system	579
X-HS-W	Wire hanging system	583
Electrical fasteners		589
X-EKB, X-ECH	Electrical fastener	589
X-DFC	Double fire clip	595
X-MCT-FE MX	Metal cable tie holder	599
X-MCT MX	Metal cable tie holder	603
X-ECH-FE MX,		
X-EKB-FE MX	Circuit integrity fastener	609
X-EAS-FE MX	Stand-off single cable holder	613
X-FB	Electrical conduit fastener	623
X-DFB, X-EMTC	Electrical conduit fastener	635
X-FB-E,		
X-DFB-E	Electrical conduit fastener	641
X-UCS MX	Universal conduit saddle	645
X-UCS-S MX	Universal conduit saddle for rigid pipe	649

X-ECT MX, X-UCT MX, X-EKS MX	Electrical cable tie and conduit clip fastener	653
X-UCT-E MX	Universal cable tie holder	659
X-ET	Nail for fastening plastic electrical cable tray and junction box	663
X-TT	Textile tape	667
Wood nails		669
GX-WF	Wood framing nail	669
Part 5: Approvals		679
Nails → Approvals		681
Approvals → Nails		701



Part 1:

Direct fastening principles and technique

1. Introduction

1.1 Definitions and general terminology

Hilti direct fastening technology is a technique in which specially hardened nails or studs are driven into steel, concrete or masonry by a piston-type tool. Materials suitable for fastening by this method are steel, wood, insulation and some kinds of plastic. Fastener driving power is generated

by a power load (a cartridge containing combustible propellant powder, also known as a “booster”), combustible gas or by a battery. During the driving process, base material is displaced and not removed. In Hilti terminology, DX stands for “powder-actuated”, GX for “gas-actuated” and BX stands for “battery-actuated” systems (i.e. propellant free).”

1.2 Reasons for using direct fastening

“The illustrations below show some of the main reasons why many contractors take

advantage of the benefits of powder-, gas- or battery-actuated fastening.

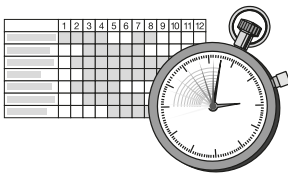

Speed is important.

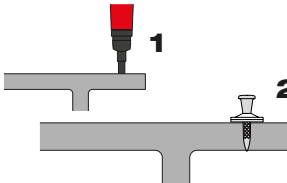

An easy-to-use, uncomplicated fastening system is required.

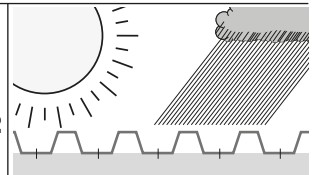

A weather-independent fastening system is required.



Electric power is not available or electric cables would hinder the work.

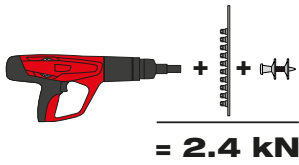

A complete fastening system with assured strength is required.



Drilling is not viable because of noise.

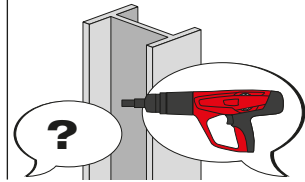

Drilling would be too difficult.

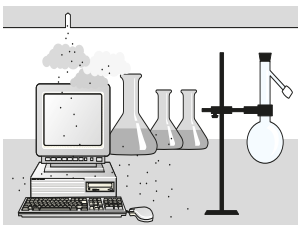

Drilling would cause too much dust.

In addition, there are specific reasons why contractors may use battery-actuated fastening:



Gas cans or combustion systems are not allowed

1.3 Direct fastening applications

Typical applications for powder- or gas-actuated fastening are shown in the illustrations below:

- Fastening thin metal sheets: roof decking wall liners and floor decking
- Fastening thicker steel members: e.g. metal brackets, clips
- Fastening soft materials such as wooden

battens or insulation to steel, concrete or masonry

- Threaded studs for suspended ceilings, installing building services, bar gratings or chequer plate floors
- Connections for composite structures: fastening nailed composite shear connectors

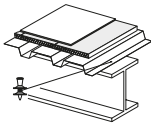

Roof decking

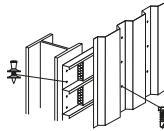

Wall liners

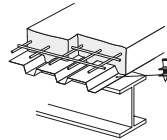

Floor decking

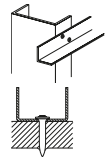

Metal brackets, clips and tracks

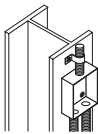

Fixtures for mechanical and electrical installations

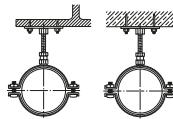

Hangers with threaded connectors

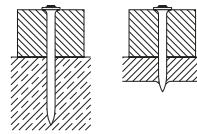

Wooden battens fastened to steel or concrete

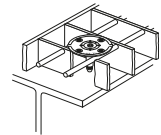

Grating fastenings

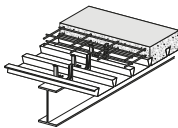

Shear connectors

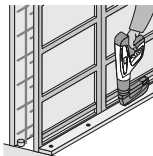

System formwork

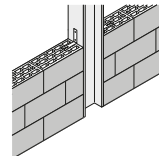

Wall-tie to steel and concrete

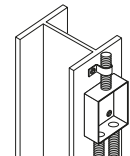

Mechanical and electrical fixtures

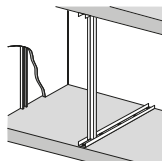









Drywall track to concrete and steel

2. The direct fastening system

The fastener, tool and driving energy form a fastening system with its own specific characteristics. Examples of Hilti direct

fastening system components are shown below.

Fasteners	Fastening tools	Driving energy
		
Powder-actuated tool		
		
Gas-actuated tool		
		
Battery-actuated tool		

2.1 Fasteners

Fasteners can be classified in three general types: nails, threaded studs and composite fasteners.

Nails

Siding and decking nails



General purpose nails

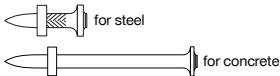

Threaded studs

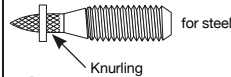

Blunt-ended fastener
(requires pre-drilling)

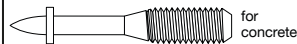

Pre-mounted fasteners

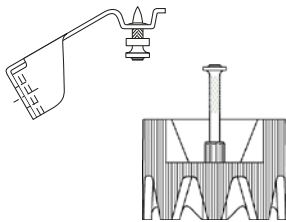

Multi-part fasteners

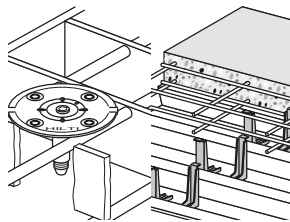

The nails used (also known as drive pins) are of a special type equipped with washers to meet the needs of the application and to provide guidance when driven. Threaded studs are essentially nails with a threaded upper section instead of a head. Composite fasteners are an assembly consisting of a nail with an application-specific fastening component such as a clip, plate or disk made of metal or plastic.

Siding and decking nails can be recognized by their washers which are specially designed to hold down the metal sheets and to absorb excess driving energy. Fasteners designed for driving into steel usually have

knurled shanks which increase their pull-out resistance. Fasteners for use on concrete have longer shanks than those for use on steel. Threaded studs may have either a metric (M6, M8 or M10) or Whitworth ($1/16''$, $5/16''$ or $3/8''$) thread.

Nails and threaded studs are commonly zinc-plated for resistance to corrosion during transport, storage and construction. As this degree of protection is inadequate for long-term resistance to corrosion, use of these zinc-plated fasteners is limited to applications where they are not exposed to the weather or a corrosive atmosphere during their service life. The zinc layer on

fasteners driven into steel is, in fact, a disadvantage in that it reduces pull-out resistance. For this reason, the thickness of zinc on the fastener must be optimized to ensure good corrosion protection as well as high holding power. During production, tight control of the galvanizing process is necessary to prevent excess zinc thickness and thereby poor fastening performance. Fasteners must be 2 to 3 times harder than the material into which they are driven. The tensile strength of structural steel is

commonly between 400 and 600 MPa. Fasteners for use on steel thus require a strength of approximately 2000 MPa. As Rockwell hardness is much easier to measure than strength, but good correlation exists between hardness and strength, this characteristic is used as a parameter in the specification and manufacturing of the fasteners. In the table below, HRC hardness is given for a range of tensile strengths (DIN 50150).

Tensile strength									
(MPa)	770	865	965	1810	1920	1995	2070	2180	2215
HRC	20.5	25.5	30	52.5	54	55	56.5	58	59

2.2 Manufacturing process

Standard hardened steel fasteners

Almost all power-actuated fasteners used throughout the world are manufactured from carbon steel wire which is subsequently thermally hardened to provide the strength needed for driving into steel and concrete. In nail manufacturing, shank diameter is determined by the wire diameter used. Threaded studs are made from wire corresponding to the required thread diameter. The manufacturing process, which is summarized in the diagram below, consists of cutting the wire to length, shaping the head, knurling, forging or thermo pulling the point, hardening, galvanizing and assembling with washers. The process of hardening the steel to more than HRC 50 combined with the zinc plating presents a risk of hydrogen embrittlement. This risk is mitigated by heat-treating the

galvanized product at the optimum temperature for the correct time. Galvanized and heat-treated fasteners are subjected to impact bending tests to check the effectiveness of the process. Depending on their intended application, some fasteners are additionally sampled and tested under tension and shear.

Manufacturing Process

Standard zinc-coated fasteners



Stainless steel fasteners

Hilti introduced the first powder-actuated stainless steel fastener in 1994. These fasteners, which are not thermally hardened, are manufactured from special stainless steel wire with an ultimate tensile strength of 1850 MPa. One effect of using steel of such high strength as a raw material is that the forming and forging processes present greater technical difficulties. These fasteners, on the other hand, suffer no

risk of hydrogen embrittlement and their strength decreases only very slightly when subjected to high temperatures such as in a fire.

Manufacturing Process Stainless Steel Fasteners

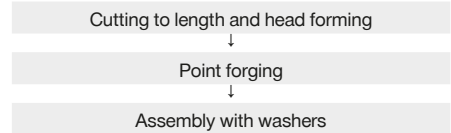

2.3 Fastener raw material

Hilti standard zinc plated fasteners are made from carbon steel wire with an ultimate tensile strength of 590 to 760 MPa.

Hilti X-CR / X-BT stainless steel fasteners are made from high-strength nitrogen alloyed stainless steel wire (Hilti designation CR500) or ferritic-austenitic corrosion resistant duplex steel 1.4462.

Nickel and chromium are the components of stainless steel that make it resistant to corrosion. CR500 steel is compared to commonly used stainless steels like AISI 304 and 316 (European A2 and A4) in the graph at the right. Note that CR500 steel contains considerably more nickel and chromium than both 304 and 316.

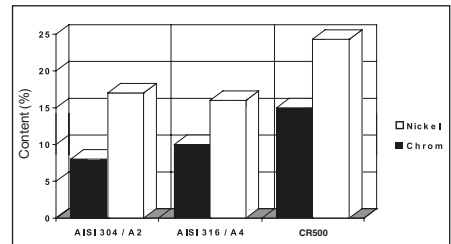

Another comparison of interest is the difference in ultimate tensile strength, as shown in the graph at the right.

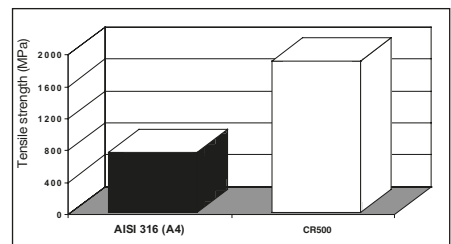

2.4 Types of Hilti direct fastening tools

Hilti currently offers three types of direct fastening tools: powder-actuated, gas-actuated and battery-actuated.

2.4.1 Powder-actuated tools



These tools rely on cartridges of different power levels as propellant. When ignited, the cartridge transfers energy to a piston which, in turn, drives the fastener into the base material.

All Hilti powder-actuated tools are classified as low-velocity tools.

Class of powder-actuated tool	Average test velocity in m/s [fps]	Maximum single test velocity in m/s [fps]
Low-velocity	100 [328]	108 [354]
Medium-velocity	150 [492]	160 [525]
High-velocity	>150 [492]	>160 [525]

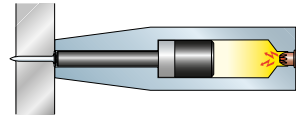

2.4.2 Gas-actuated tools



These tools rely on gas as propellant. Expanding the gas transfers energy to a piston which, in turn, drives the fastener into the base material.

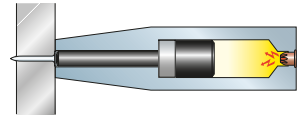

Hilti manufactures gas-actuated tools using two distinct technologies. The first (used notably in models GX 2 and GX 90 WF) uses a fan to mix the propellant with ambient air. The second (used notably in the GX 120 and GX 3) uses a Hilti-designed mechanism requiring no external power to mix the gas and air in the combustion chamber.

2.4.3 Battery-actuated tools



This tool is propellant-free. The energy moving the piston is generated by an electrical motor, two springs and a belt. The only source of energy required is a 22V battery which is interchangeable with other tools from the Hilti 22V platform family.



2.5 Operating principles

All Hilti direct fastening tools feature a piston. There are three ways the piston can come into contact with the fastener when an operator triggers a tool – referred to as operating principles. They are described in the diagram below.

It is important to bear in mind that the operating principle used for a given fastening point modifies the application's limit, particularly when fastening on steel.

Operating principle	Characteristics	
Co-acting operation	<ul style="list-style-type: none"> • $X > 0$; $Y = 0$ • Highest application limit • Lowest recoil 	
Impact operation	<ul style="list-style-type: none"> • $X = 0$; $Y > 0$ • Lower application limit • Higher recoil 	
Contact operation	<ul style="list-style-type: none"> • $X = 0$; $Y = 0$ • Lowest application limit • Highest recoil 	

It should be noted that 100% co-acting operation in Hilti tools can be only achieved by pushing the fastener all the way against the piston with a ramrod or, if the tool is so designed, with a built-in ramrod mechanism. Tools with nail magazines cannot operate with 100% co-action because of the need for clearance between the piston end and the collated nail strip. Some single-shot tools allow the operator to make an impact-type tool work as a co-acting tool by using a ramrod.

2.5.1 Cartridges (power loads, boosters)

Cartridges for powder-actuated fastening tools are available in various standard sizes and each size is available in up to 6 power levels. In the United States, the powder in a cartridge, the sensitivity of the primer, and the cartridge dimensions are governed by technical data published by the Powder-Actuated Tool Manufacturers Institute, Inc.

(PATMI). PATMI defines the power level by the velocity measured in a standard test in which a standardized 350 grain [22.7gram] cylindrical plunger is fired from a standardized apparatus. The identification and limitations of use are addressed in ANSI A10.3-2013.

PATMI colour codes, power levels and definition of cartridges

Size	Colour code	Power level	Velocity of 350 grain slug		Calculated energy (joules)		
			ft./sec.	[m/sec.]	minimum	average	maximum
6.8 / 11 [Cal. 27 short]	Gray	1	370 ± 45	[113 ± 13.7]	111	144	182
	Brown	2	420 ± 45	[128 ± 13.7]	148	186	228
	Green	3	480 ± 45	[146 ± 13.7]	200	243	291
	Yellow	4	560 ± 45	[171 ± 13.7]	280	331	386
	Red	5	610 ± 45	[186 ± 13.7]	337	392	452
	Purple / black	6	660 ± 45	[201 ± 13.7]	399	459	524
6.8 / 18 [Cal. 27 long]	Green	3	550 ± 45	[168 ± 13.7]	269	319	373
	Yellow	4	630 ± 45	[192 ± 13.7]	361	419	480
	Blue	4.5	725 ± 45	[221 ± 13.7]	488	554	625
	Red	5	770 ± 45	[235 ± 13.7]	554	625	700
	Purple / black	6	870 ± 45	[265 ± 13.7]	718	798	883

In Europe, the European Standard EN 16264 specifies cartridge dimensions, colour codes and power levels, which are defined in terms of energy delivered

when a cartridge is fired in a standardized apparatus. EN 16264 specifies a 80 gram plunger.



EN 16264 colour codes, power levels and energy scale

Colour code	Power level	Energy scale
White/Brown	weakest	2
Green	weak	3
Yellow	medium	4
Blue	heavy	5
Red	very heavy	6
Black	heaviest	7

3. Health and safety

The safety of powder-actuated fastening systems can be clustered into two categories:

- Operator safety refers to safeguarding the operator and bystanders.
- Fastening safety refers to the adequacy of the in-place fastenings.

3.1 Operator safety

This refers to the measures taken to ensure that the tool does not endanger the operator and/or bystanders by firing at an overly high velocity, firing under the wrong conditions, generating excessive noise, or being used in the wrong way.

The piston principle

One of the main concerns about the use of powder-filled cartridges is the risks associated with a fastener missing the base material, or with a base material too weak to absorb the nail's energy. The piston principle ensures that the energy from the propellant in the cartridge is transferred to a piston which, in turn, drives the fastener. Because the piston is captive within the tool, it will absorb app. 95% of the driving energy in case a fastener misses the base material or the material is too soft for the fastener. As a consequence, the fastener will exit the tool at a speed that is far lower and less dangerous than that of tools which are not based on a piston.

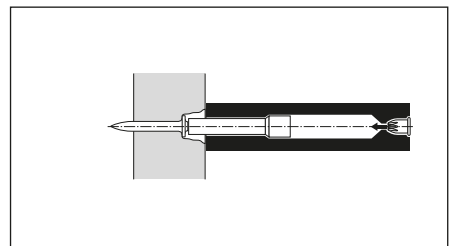
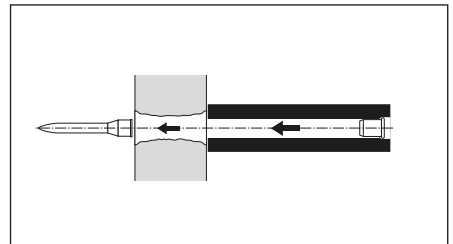

Tool safety mechanisms

To minimize the potential hazards during tool usage, Hilti has implemented the following safety mechanisms in all of its direct fastening tools.

Drop-firing safety

The drop firing safety mechanism prevents the tool from firing if dropped unintentionally. This mechanism is so designed that the tool, cocked or uncocked, will not fire when dropped at any angle onto a hard surface.

**Trigger safety**

The trigger in Hilti's DX- and GX-tools is uncoupled from the firing pin mechanism until the tool is fully compressed against the work surface. This mechanism ensures that pulling the trigger alone cannot cause the tool to fire.

**Contact pressure safety**

Hilti's direct fastening tools can only operate when pressed against the work surface. This requires a force of at least 50 N (5.1 kg, or 11.2 pounds). Tools with large base plates, such as DX 76 and GX 120, feature an additional surface contact pin that must also be pressed to allow the tool to operate.

**Unintentional firing safety**

Hilti's direct fastening tools will not operate unless first pressed against a work surface and then actioned using the trigger. This Hilti-designed feature ensures that no fastener exits a tool without the operator specifically intending it and focusing on the tool.



Powder cartridges and operator safety

EN16264 requires submitting each cartridge to overpressure tests in each of the tools for which it is intended. This ensures that the plastic collation strip is of adequate strength. EN16264 also defines the maximum amount of unburnt powder a cartridge may leave after combustion, as this residue may explode and cause injuries to the operators and to bystanders. Meeting this requirement is a prerequisite for CE conformity.

The Hilti cartridges come in packages that address all the norms mentioned above. Each package displays cartridge energy level, marking on US scale and on European scale, in addition to the CE marking and CIP logo, as in the following picture illustrated.

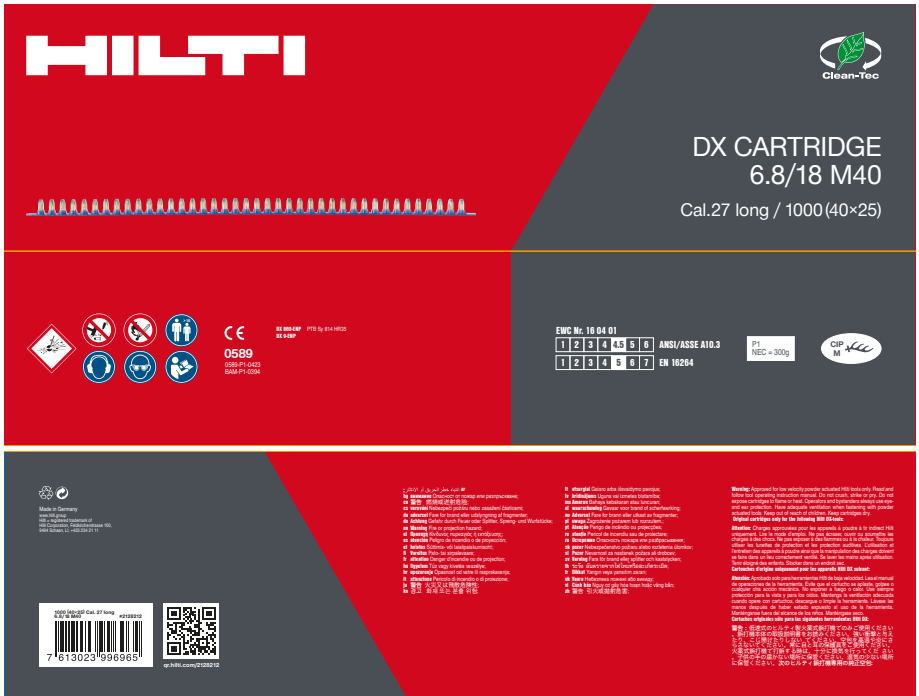

The identification and limitations of cartridge use in the U.S. are addressed in the ANSI/ASSE A10.3 norm.

Always review and follow the Operating Instructions in addition.

Gas cans and operator safety

Norms and standards relevant to gas cans include EN12205 and ISO 11118 as of 2018, which regulate the physical structure of gas cans. They also include the UN 1950 or UN 3150 norms, which define the conditions under which gas can shipping and distributing is considered safe. Regional regulations also apply depending on the operator's location: ADR/RID for Europe and ORM-D for the United States. All Hilti gas cans strictly abide by these norms.

To ensure that Hilti's gas cans are used in the appropriate conditions, each can features safety information in text and pictogram formats. In particular, it displays its expiry date, the maximum temperature it may be exposed to, its pressure level, and the "Extremely flammable" logo. The enclosing package also displays this information, in addition to recommended storage conditions. And the accompanying leaflet provides the complete list of potential hazards associated with the gas can.

GC 42 for use with the Hilti GX 3 tool.

For professional use only. Strictly for intended use only. Read the operating instructions and the safety regulations before use. Keep out of reach of children. **See edge of can for expiration date and lot number. Extremely flammable gas. Contains gas under pressure; may explode if heated. Contains Isobutane, Propane, Propane.** Pressurized container. Do not pierce or burn, even after use. Protect from sunlight. Do not expose to temperatures exceeding 50°C/122°F. Do not spray on an open flame or other ignition source. Keep away from heat/sparks/open flames/hot surfaces. — No smoking. Store the container in a well ventilated place. Recommended storage temperature: 5°C to 25°C (41°F to 77°F).

GC 42 Gasdose zur Verwendung im Gerät Hilti GX 3.

Nur für professionellen Gebrauch. Benutzung ausschliesslich gemäss Verwendungszweck. Vor der Inbetriebnahme Bedienungsanleitung und die Sicherheitsvorschriften lesen. Darf nicht in die Hände von Kindern gelangen. **Verfallsdatum und Abfüll-Los siehe Dosenrand. Extrem entzündbares Gas. Enthält Gas unter Druck; kann bei Erwärmung explodieren. Enthält: Isobutan, Propan, Propan.** Behälter steht unter Druck: Nicht durchstechen oder verbrennen, auch nicht nach der Verwendung. Vor Sonnenbestrahlung schützen und nicht Temperaturen von mehr als 50 °C/122°F aussetzen. Nicht gegen offene Flamme oder andere Zündquelle sprühen. Von Hitze/Funkentöffener Flammheissen Oberflächen fernhalten - Nicht rauchen. Nur in gut gelüfteten Bereichen verwenden. Behälter an einem gut gelüfteten Ort aufbewahren. Empfohlene Lagertemperatur 5°C bis 25°C (41°F bis 77°F).

GC 42 pour système Hilti GX 3.

Usage réservé aux professionnels, uniquement dans le cadre d'une utilisation normale. Lire le manuel d'utilisation et toutes les instructions de sécurité avant utilisation. Tenir hors de portée des enfants. **Date d'expiration sur la bordure de la cartouche. Gaz extrêmement inflammable. Contient un gaz sous pression; peut exploser sous l'effet de la chaleur. Contient: Isobutane, Propane, Propane.** Récipient sous pression: ne pas perforez, ni brûler, même après usage. Protéger du rayonnement solaire. Ne pas exposer à une température supérieure à 50 °C/122 °F. Ne pas vaporiser sur une flamme nue ou sur toute autre source d'ignition. Tenir à l'écart de la chaleur/des étincelles/des flammes nues/des surfaces chaudes. - Ne pas fumer. Stocker les cartouches dans un endroit bien ventilés. Température recommandée pour le stockage: 5°C à 25°C (41°F à 77°F).

81 ml 115 3e

(2.74 fl. oz.)

Made in Germany

www.hilti.com

Hilti Corporation, FL-9494 Schaan, Tel. +423/234 21 11

Hilti = registered trademark of Hilti Corporation, Schaan, LI



Danger
Gefahr

2108613-10/2014

To enable the efficient tracking of any issue, the production lot number is also printed on each gas can and package.

The side illustration shows the typical graphical layout of a Hilti gas can.

The Hilti tools only operate with Hilti gas cans. This ensures that the tool receives gas in the right amount and composition, minimizing safety risks.

Noise-related operator safety

Hilti measures the noise its direct fastening tools emit as per the EN 15895 international standard to help operators and safety engineers plan the work in a way that minimizes risks. However, it should be noted that other ambient construction noises frequently compound with the tool's noise, which warrants additional precautions to protect operators. As a general rule, operators should always wear ear protection when operating the tools.

Vibration-related operator safety

Hilti direct fastening tools are not considered to produce vibrations as defined in international standards. However, as a precautionary measure, it is recommended to use the weakest possible cartridges to perform any given task, as well as to follow the instructions contained in the IFU.

Promoting operator safety through signaling and documentation

To ensure the safety of the operator and of bystanders, it is essential to follow the instructions contained in the Operating Instructions. Safety measures are also featured on pictograms inside the product carrying cases and on the consumables.



Hilti also covers safety measures as part of the operator training modules its local offices offer. The operators completing training receive a certificate of completion and/or an operator ID as required by local regulations. In some countries, the operators also get access to online material that serves as a refresher.

3.2 Fastening safety

The safety of a fastening point depends for a good part on the manufacturer correctly anticipating the conditions in which its tools and fasteners will be used on jobsites. This involves:

- 1) engineering and testing fastening systems within the framework of specific applications
- 2) ensuring that the finished products strictly match their technical specifications
- 3) ensuring that the fastening work on jobsites is performed as it is intended to be

Engineering and testing

Sources of information about the engineering and testing of a fastening system include the manufacturer's technical literature, official approvals and publications in technical journals. Hilti provides all of these for its products.



The use of a non-Hilti fastening system by an operator should be made contingent upon proof that the fastening system has been engineered and tested for the application the operator intends to perform.



Finished product quality

It is important that the manufacturer have a production quality control system. This is necessary for ISO 9001 certification. All Hilti production facilities are 9001 certified.

3.3 Quality of installation

Hilti contributes to the quality of the fastening work in the four following ways:

- 1) It provides application guidelines.
- 2) It provides technical advisory services.
- 3) Each box of nails designed and/or approved for specific applications comes with a plastic gauge enabling the operator to check if the nail's stand-off on the base material is within the acceptable margin
- 4) It manufactures devices enabling the tensile testing of fasteners. Threaded studs and certain decking fasteners can be tested in their final position on a jobsite. Other fasteners can be tested using a pull-over test specimen.



Checking the standoff of an ENP2 roof deck fastening with a plastic gauge



Pull-out test of an ENP fastening with a HAT28 tester and X-ENP adapter

As construction professionals demand fastening systems that are dependable without question, Hilti integrates functional reliability into the development, manufacturing, selling and servicing of its fastening systems. It does so paying particular attention to the reliability level required of each system, and the conditions in which it will be used.

During the development phase, Hilti engineers test the reliability of prototypes and system components regularly. In the plant, quality controls take place throughout the manufacturing process to ensure that the products are produced according to specifications.

When the first pilot production lots are delivered, contractors test them on jobsites. Adequate performance by the pilot production lots ensures that the products will be of good quality when mass-produced.

Hilti's sales staff gets trained to be in a position to advise customers on which system to use for their application, demonstrate how to use tools, and warn them about potential hazards.

Finally, Hilti's highly skilled tool repair and maintenance staff ensures that the fastening system functions optimally over the long run.



4. Corrosion

For decades, Hilti is concerned about corrosion of fastening systems and has gained a lot of experience in this area based on laboratory- and field tests. Extensive testing and research are conducted in test facilities of Hilti Corporate Research department, located around the world in different climate zones. Hilti strives to provide the best possible

support to customers for selecting the right product for safe and reliable fastening solutions.

This chapter gives an overview of corrosion protection solutions for Hilti Direct Fastening elements. More details on corrosion are described in the Hilti corrosion brochure „Corrosion handbook 2015“.

4.1 Corrosion protection of direct fastening systems

Carbon steel fasteners are subject to corrosion (red rust) when exposed to humidity.

Zinc is the coating most commonly applied on fasteners. Humidity attacks it before it attacks the carbon steel core. Thanks to Zinc's electro-chemical properties, this produces white rust on the coating but delays the formation of red rust on the core material.

Zinc has different removal rates depending on the surrounding environment.

The lifetime of zinc-based protection against corrosion is a function of two parameters: the environment's aggressiveness and the zinc's thickness. Depending on the degree of anti-corrosion protection required, additional layers of Zinc can be applied through passivation or organic topcoat.

Different variants of coating systems can be used to prevent fasteners from rusting. They are described in the following paragraphs.

Galvanic zinc coating:

This type of coating is generally suitable for environments with no corrosive potential. It is typically applied via an electrochemical process. Thicknesses up to 20 microns are possible, including passivation layer.

Hot dip galvanizing (HDG):

HDG is applied by dipping the parts to be protected against corrosion in a liquid zinc bath. The coating thickness can reach up to 80-100 microns, offering additional protection compared to galvanic zinc.

Duplex coating:

An alternative to hot dip galvanizing is duplex coating, i.e. the combination of a galvanic zinc layer with an supplemental reactive sealer the zinc in a first period. The equivalence in the protection offered by duplex coating and by HDG has been demonstrated on numerous occasions at Hilti test facilities around the world as well as at independent external labs. Duplex coating is applied to many Hilti grating fasteners, X-FCM-M.

Mechanical zinc plating:

Another alternative to hot dip galvanizing is mechanical plating. In this process, the zinc layer is built from zinc powder that is mechanically pressed onto the surface of the parts to protect. The equivalence in the protection offered by mechanical zinc plating and by HDG has been demonstrated on numerous occasions at Hilti test facilities around the world as well as at independent external labs.

Mechanical plating is applied on some Hilti nails and pins used in direct fastening.

Hydrogen embrittlement:

Hydrogen embrittlement is a specific corrosion phenomenon of zinc plated DX fastening elements, which will occur if three different conditions are present simultaneously:

- High strength carbon steel (>1000 MPa)
- Presence of hydrogen
- Tensile stresses

The combination of these three parameters leads to a decrease in the material's ductility, which may cause a sudden fastener failure even under very low static load.

The strength of fasteners is a function of its design and of the acceptable load in each application. Therefore, it is important to control the presence of hydrogen in the fasteners to prevent embrittlement from occurring. There are two main sources of hydrogen for zinc plated fasteners:

- The production process (primary hydrogen embrittlement): Hilti's power actuated fasteners are thoroughly tested and controlled during the production process to prevent primary hydrogen embrittlement.
- The corrosion process in the application (secondary hydrogen embrittlement): When zinc plated, high-strength fasteners are used in wet atmosphere, hydrogen is formed by the chemical reaction of zinc and water and diffuses into the material. To avoid secondary hydrogen embrittlement during the service life of a fastener, it is essential to follow the recommended application conditions provided for each nail in Hilti technical documents.

Stainless steel

Stainless steel comes in many different types, each of which has different corrosion resistance properties. A stainless steel material used in a wrong environment can lead to pitting corrosion and, subsequently, sudden fastener failure. In such a situation, predicting a fastener's lifetime is not possible.

Hilti power actuated fasteners are manufactured using CR500 and 1.4462 material, similar to A4 (AISI grade 316), which offers high performance in a wide range of applications.

For higher corrosion requirements, fasteners made out of HCR (1.4529) material can be provided. The HCR (High Corrosion Resistance) material can be used in swimming pools and in road tunnels, where the performance of A4 material is not sufficient.

Stainless steel with pitting corrosion, e.g. A4 material used in a road tunnel



Suitable stainless steel used, e.g. HCR material used in a road tunnel

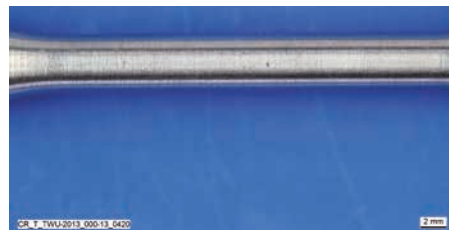

4.2 Fastener selection

Following table (next page) gives a general guideline of commonly-accepted applications in typical atmospheric environments. Suitability of fastening systems for a specific application can be significantly affected by localized conditions, including but not limited to:

- Elevated temperatures and humidity
- High levels of airborne pollutants
- Direct contact with corrosive products, commonly found in chemically-treated wood, waste water or salt water, concrete additives, cleaning agents, etc.

- Non-atmospheric corrosion like e.g. direct contact to soil, stagnant water
- Cyclical wetting
- Electrical current
- Contact with dissimilar metals
- Physical damage or wear

Environmental conditions		Fastened part		Carbon steel		Stainless steel	
				Galv. zinc coating	Duplex coating	CR500 or 1.4462 (A4, AISI 316)	HCR 1.4529
				Fastener Galv. zinc coating Duplex coating CR500 or 1.4462 (A4, AISI 316) HCR 1.4529			
				Examples X-ENP ¹⁾ , X-U X-FCM-M X-BT, X-CR On demand X-GHP X-FCM-R			
		Dry indoor	steel (zinc coated, painted), aluminum, stainless steel, wood	■	■	■	■
		Indoor with temporary condensation	steel (zinc coated, painted), aluminum, stainless steel, wood	Consult experts for exceptions	■	■	■
		Outdoor, non-safety relevant ²⁾	steel (zinc coated, painted), aluminum, wood	■	■	■	■
		Outdoor, rural or urban environment with low pollution	steel (zinc coated, painted)	—	■	■	■
			aluminum, stainless steel	—	Consult experts for exceptions	■	■
		Outdoor, rural or urban environment with moderate concentration of pollutants and/or salt from sea water	steel (zinc coated, painted)	—	Consult experts for exceptions	■	■
			aluminum, stainless steel	—	Consult experts for exceptions	■	■
		Coastal areas	steel (zinc coated, painted), aluminum, wood	—	—	■	■
	0-1 km	Outdoor, areas with heavy industrial pollution	steel (zinc coated, painted), aluminum, wood	—	—	■	■
	0-10 m	Close distance to streets	steel (zinc coated, painted), aluminum, wood	—	—	■	■
	Special applications	Road tunnels, indoor swimming pools, special applications in chemical industry	steel (zinc coated, painted), aluminum, wood	—	—	Consult experts for exceptions	■

■ = expected lifetime of power actuated fasteners made from this material is typically satisfactory in the specified environment based on the typically expected lifetime of a building. The assumed service life in ETA approvals for power actuated fasteners is 25 years.

— = fasteners made from this material are not suitable in the specified environment. Exceptions need a specific assessment.

1) Outdoor exposure for up to 6 months during construction is permissible for high-strength electro-galvanized siding and decking fasteners such as the X-ENP (see instructions for use for details)

2) The reference to “non-safety relevant” is intended to distinguish applications where failure of the attachment will not create any potential safety risks or significant damage.

Remarks:

- The ultimate decision on the required corrosion protection must be made by the customer. Hilti accepts no responsibility regarding the suitability of a product for a specific application, even if informed of the applications conditions.
- This table is based on an average service life for typical applications.
- For metallic coating e.g. zinc layer systems the end of life time is the point where red rust is visible over a large percentage of the product and widespread structural deterioration can occur – the initial onset of rust will occur much sooner
- National or international codes, standards or regulations, customer and/or industry specific guidelines must be independently evaluated.
- These guidelines apply to atmospheric corrosion only. Other types of corrosion, such as crevice corrosion or stress corrosion cracking must be independently evaluated.

A typical service life of Hilti GX-WF nails in wood - wood connections is shown below:

Service Classes in accordance with EN 1995 (Eurocode 5):		Service Class 1	Service Class 1,2	Service Class 1,2,3			
Type of Corrosion Protection for Hilti GX-WF wood nails (d ≤ 4mm):		No Corrosion Protection	Zinc coated	HDG	A2 ¹⁾	A4	
		Dry indoor	20 to 50 years	up to 50 years	up to 100 years	■	■
		Indoor environments with temporary condensation	—	10 to 50 years	60 to 100 years	■	■
		Outdoor with low pollution	—	5 to 20 years	40 to 100 years	■	■
		Outdoor with moderate concentration of pollutants	—	2 to 10 years	20 to 40 years	■	■
		Coastal areas	—	up to 5 years	10 to 30 years	—	■
		Outdoor, areas with heavy industrial pollution	—	up to 5 years	10 to 30 years	—	■
		Close distance to streets	—	—	—	—	■
	Special applications	Special applications	Consult experts for exceptions				

The table above provides typically assumed service life estimations based on corrosion considerations. Other factors determining the service life of fasteners must be evaluated separately.

- = expected lifetime of nails made from this material is typically satisfactory in the specified environment based on the typically expected lifetime of a building.
- = nails made from this material are not suitable for the environment or the typical lifetime of a building is not achieved.

1) For nails made of A2 material, discoloration of nail heads can occur before the service life in the table above is reached. To avoid this, use A4 material.

Remarks:

- The use of certain wood species including, but not limited to, Oak, Douglas-fir or Western Red Cedar, require the use of stainless steel nails, independent of Service Class and environmental conditions.
- The use of certain wood treatments including, but not limited to, fire retardants or preservatives can change the chemical composition of the wood and may require the use of stainless steel nails, independent of Service Class and environmental conditions.
- The evaluation of corrosive environmental conditions depends on many factors and lies within the responsibility of the customer. The planned service life of the buildings or structures can be considered according to local or national building regulations and Eurocode (EN 1990)
- The table does not contain recommendations and Hilti does not assume liability for fastener selection based on its content.
- For the typical service life, it is assumed that the nails are selected, designed, installed and otherwise treated in accordance with Hilti's published literature.
- Local building regulations and trade rules may differ from the table above. The local jurisdiction always needs to be followed.
- Wood to steel connections may require a minimum corrosion protection, independent of the environmental conditions.

5. Steel base material

5.1 Anchoring mechanisms

The following four mechanisms cause a fastener to hold when driven into steel:

- clamping
- keying
- fusing (welding)
- soldering

These mechanisms have been identified and studied by analyzing pull-out test data and by microscopic examination of fastening cross-sections.



Clamping

As a fastener is driven, the steel is displaced radially and towards both the entry and opposite surfaces. This results in residual pressure on the surface of the nail, which leads to friction or clamping. Clamping is the primary anchoring mechanism of through-penetrating fasteners. This is indicated by the fact that when through-penetrating fasteners are extracted, the pull-out force decreases only slowly over several millimeters of displacement.

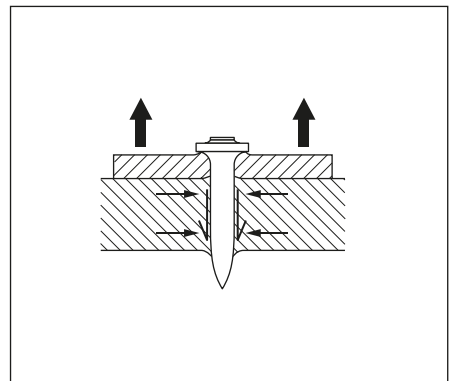

Keying

The keying mechanism is possible when the fastener is knurled, that is, it has fine grooves along the shank in which zinc and particles of base steel accumulate during the driving process. Microscopic examination of cross sections has shown that the grooves are not completely filled. Keying is an especially important anchoring mechanism for fasteners that do not penetrate right through the base material.

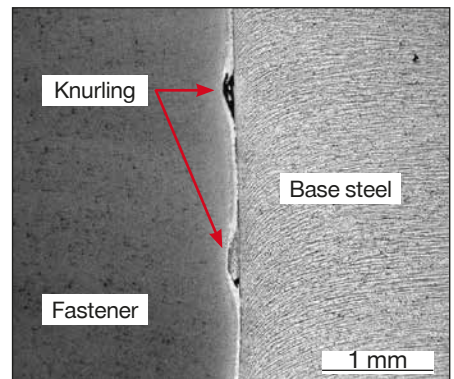

Fusing (welding)

Complete fusing of the fastener with the base steel is indicated by portions of base material clinging to the extracted fastener. Fusing or welding is observed mostly at the point of a fastener where the temperature during driving can be expected to be the highest.

For fasteners that do not through-penetrate, this is an important anchoring mechanism. It can be relied upon only if the fastener point is manufactured without cracks and with an appropriate geometry. The thermo pulling process is ideal for achieving an optimized geometry. Control of all steps in the production process is necessary to avoid

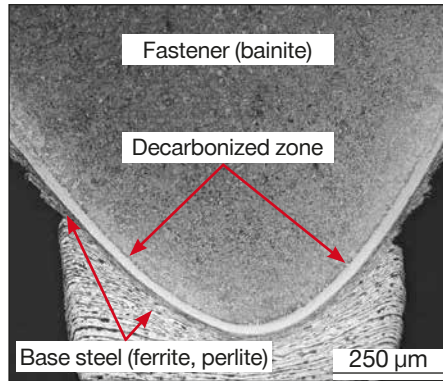

cracks in the point.

Soldering

In the zone further from the point, there is a prominent zinc layer separating the fastener from the base steel. This zinc, soldered to the base steel, also makes a contribution to the pull-out resistance of the fastener.

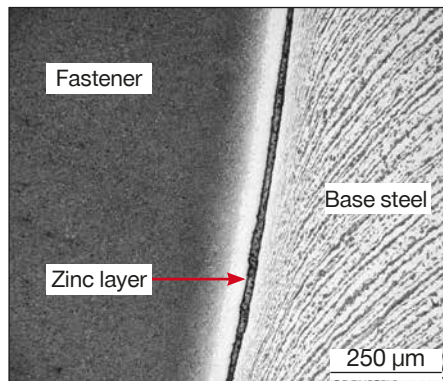

Blunt-tipped fastener X-BT family

The X-BT fastener with a shank diameter of 4.5 mm is driven in a pre-drilled 4.0 mm diameter hole. This leads to displacement of the base material. Part of the base steel is punched down into the pre-drilled hole, generating high temperatures and causing friction welding. Due to elasticity of the base steel, additional clamping effects are also superposed.

Displaced base material can be clearly seen in the photograph. Base material adhering to the fastener shank indicates a welding effect.



5.2 Factors influencing pull-out resistance

Powder-actuated fastening systems must be designed and manufactured to ensure that pull-out resistance will be adequate for the applications intended. Through understanding of the anchoring mechanisms, experience and testing, factors that influence pull-out strength have been identified. Some of these factors are:

- Depth of penetration in the base material
- Surface characteristics of the fastener
- Coatings on the steel base material
- Driving velocity
- Diameter of the fastener shank

Knowledge of the influencing factors is vital to the design of fastening systems and is useful for operators in understanding the various application guidelines and restrictions that apply to a fastening system. Some of the influencing factors are discussed in the following section.

Depth of penetration in the base material

The depth of penetration of fasteners in steel is taken as the distance that the point travels below the surface of the base steel, independent of the steel thickness. In other words the depth of penetration h_{ET} can be greater than, equal to or less than the steel thickness.

Resistance to pull-out increases with increasing depth of penetration. This is also true for through-penetrating fasteners where h_{ET} is greater than the steel thickness. The design of a powder-actuated fastener has to take into account the depth of penetration necessary to achieve the pull-out resistance required for the application. Application guidelines published for any fastener include the required nail head stand-off h_{NVS} , which corresponds to the penetration depth.

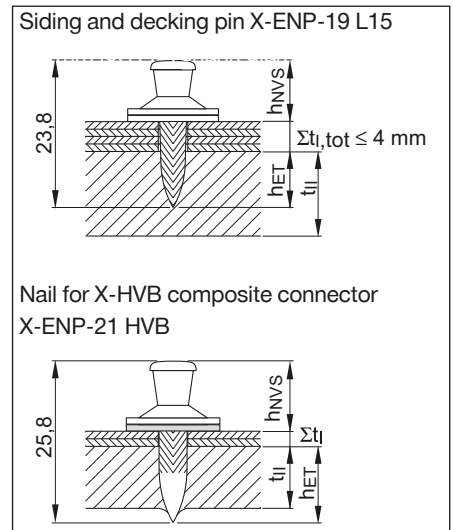

Guide values for the depth of penetration of specific fastener types are as follows:

- Galvanized fastener with knurled shank: $h_{ET} = 12$ to 18 mm (shank diameter 4.5 mm)
- Galvanized fastener with knurled tip: $h_{ET} = 10$ to 14 mm (shank diameter 3.7 mm)
- Galvanized fastener with knurled tip: $h_{ET} = 9$ to 13 mm (shank diameter 4.5 mm)
- Galvanized fastener with smooth shank: $h_{ET} = 15$ to 25 mm
- Stainless steel fastener with smooth shank: $h_{ET} = 9$ to 14 mm
- Blunt-ended fasteners: $h_{ET} = 4$ to 5 mm

The effect of penetration depth on pull-out strength can be demonstrated in experiments in which the driving energy is varied so as to produce varying penetration. The results of a test of this kind are summarized below. The application recommendations for fasteners are based on tests like these and they clearly show the importance of carrying out the fastening installation in accordance with the recommendations of the manufacturer.

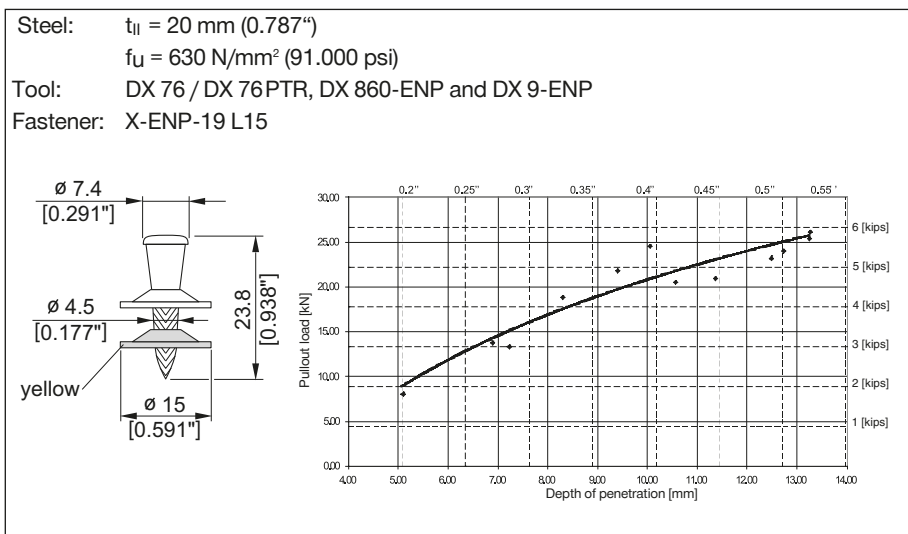

Knurling on the fastener shank

Fasteners for use in steel base material usually have knurling on the shank so as to improve the resistance to pull-out. The effect of the knurling was shown in a test with fasteners that had knurled and unknurled shanks, but were otherwise the same.

The benefit of knurling is clearly seen from the test results. With virtually the same penetration (actually 106%), the smooth-shank fastener had only 68% of the pull-out strength of the knurled-shank type. Even with the penetration increased to 137%, the pull-out strength was still only 81% of that of the knurled-shank fastener. In this test, the steel thickness of 10 mm (0.394") allowed through penetration of the steel. If the steel is too thick for through penetration, the beneficial effect of knurling becomes even more pronounced.

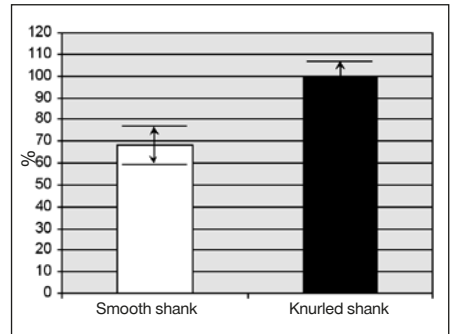

Zinc coating on the fastener shank

Zinc on a fastener shank appears to act as a lubricant that reduces its resistance to penetration into steel. Reduced pull-out strength is the result, because the lower resistance means less heat is generated, thus reducing the welding effect between the shank and the base steel. This was shown in an experiment with fasteners that were identical except for the thickness of zinc coating.

Steel base material: $t_{II} = 20 \text{ mm [0.787"]}$,

$f_u = 440 \text{ MPa [63,817 psi]}$

Zinc thickness in mm	Average penetration		Average ultimate pull-out load		Variation CV %
	h_{ET} mm / [in.]	%	$N_{u,m}$ kN / [kip]	%	
ca. 10	12.12 [0.477]	100	8.53 / [1.918]	67	25.6
2-5	11.86 [0.470]	98	12.82 / [2.882]	100	9.3

Although driving the fastener through sheet metal, as is the case when fastening siding and decking, reduces the negative effect of zinc coating on pull-out strength, the reason for tightly controlling the galvanization process is clear.

Surface of the steel base material

Corrosion protection of structural steel is often achieved by hot-dip galvanizing. Tests have shown that if the fastener penetrates right through the steel, the galvanizing has no significant effect on pull-out strength. In the case of fasteners that do not through-penetrate, pull-out strength is reduced by about 25%. The summary of results from one test is shown below to illustrate these effects.

Average ultimate pull-out loads

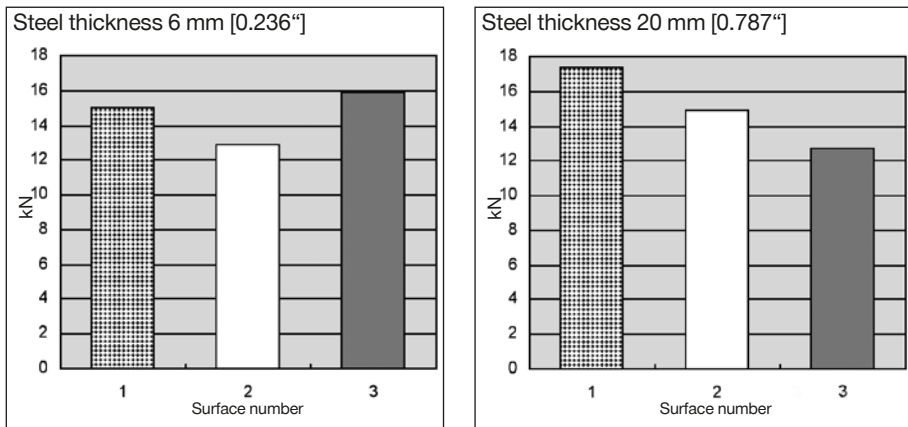

Ultimate tensile strength of steel :
Surface of the steel :

$f_u = 430 \text{ MPa [62,366 psi]}$
1. Rough with some slag and rust (reference)
2. Sandblasted
3. Pickled + hot-dip galvanized (min. 60 μm zinc)

Several important observations can be made based on these results:

- Pull-out loads in 6 mm ($1/4"$) steel base material are much less affected by the surface condition of the steel than they are in 20 mm ($3/4"$) steel. The reason is that the main anchoring mechanism of through-penetration fastenings is clamping, which is not affected by the surface condition of the steel.
 - Hot-dip galvanizing appears to reduce the pull-out strength of non-through-penetrating fastenings by nearly 30%. Note, however, that even with hot-dip galvanizing, the pull-out strength was still 12.5 kN (2.8 kips).
 - The negative effect of hot-dip galvanizing is explained by the tendency of zinc on the fastener to act as a lubricant that reduces heat generation during driving. This in turn reduces the tendency of the fastener point to fuse to the base steel. Zinc from the coating on the base steel apparently becomes attached to the fastener as it enters the base steel.
- For applications where tensile strength of the fastening is critical and the steel has a heavy coating, the fastening system can be qualified by carrying out pull-out tests on site. If pull-out strength is not adequate, depth of penetration can be increased to improve the situation.

Tensile stress in the steel

The integrity of a powder-actuated fastening is dependent on a relatively smooth pin remaining anchored in structural steel. A large amount of test data, technical assessments, approvals and practical experience with powder-actuated fastenings is available to support use of powder-actuated fastening. Performance of fasteners anchored in the steel under tension was investigated by driving fasteners into unstressed steel plates and extracting them with the plates stressed in tension. The steel plates measured 6x80x455 mm [0.236" · 3.15" · 17.9"] and possessed two different yield stresses - 328.6 MPa [47.7 ksi] and 411.7 MPa [59.7 ksi].

By expressing the steel stress in terms of % of actual yield, it was possible to combine the data for both steel grades and obtain a reasonable curve fit.

Of significance to the designer is the expected decrease in pull-out strength of the fastener at a typical maximum allowable design stress of 60 to 70 % of yield. At this stress, the pull-out strength reduction is less than 15%. The absolute value in the experiment was still greater than 2 tons.

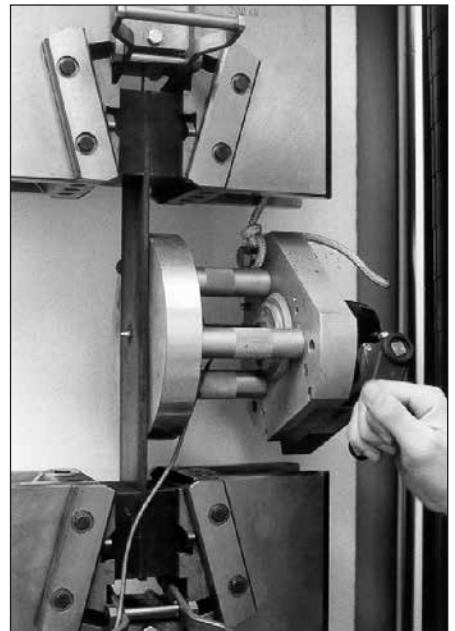
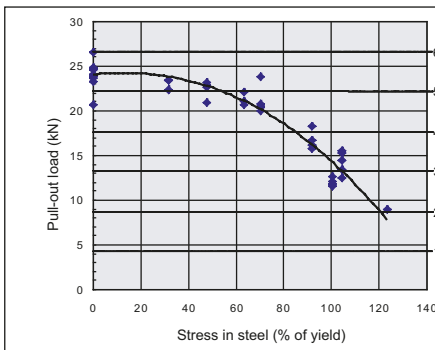

Compressive stress in the steel

Compressive stress in the base steel has no influence on the pull-out strength of the fastener. This was demonstrated by placing fasteners in unstressed 15 mm [0.59"] thick steel plates having a yield strength of 259.3 MPa [37.6 ksi] and extracting them while the plates were compressed in a testing machine.

The minimal variation in pull-out load is simply random variation experienced in testing.

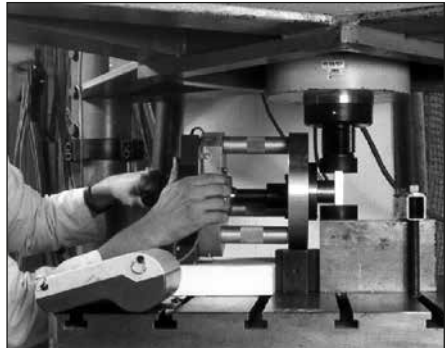
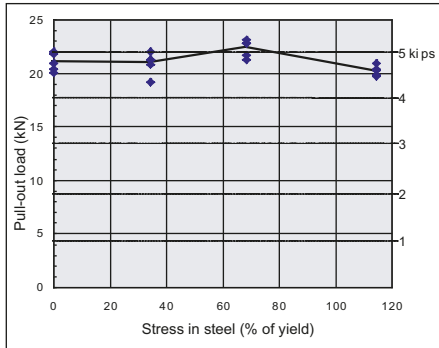

5.3 Suitability of the steel for fastening

There are three main factors determining the suitability of a construction grade steel member for DX fastening:

- Steel thickness
- Ultimate tensile strength
- Flexibility of the base steel member

5.4 Application limit diagrams

The application limit of a fastening system is a term applied to a combination of the maximum thickness t_{II} and ultimate tensile strength f_u of steel in which fastenings can be made. There are two general types of application limit diagrams:

- Short fasteners (e.g. siding and decking nails and threaded studs)
- Long fasteners (e.g. nails used to fasten wood to steel)

The application limit line for a short fastener is a plot of steel thickness versus ultimate tensile strength. In situations represented by steel thickness / ultimate tensile strength combinations above and to the right of the line, some of the fasteners may shear off during driving. The failure surface will be roughly at a 45° angle to the shank length.

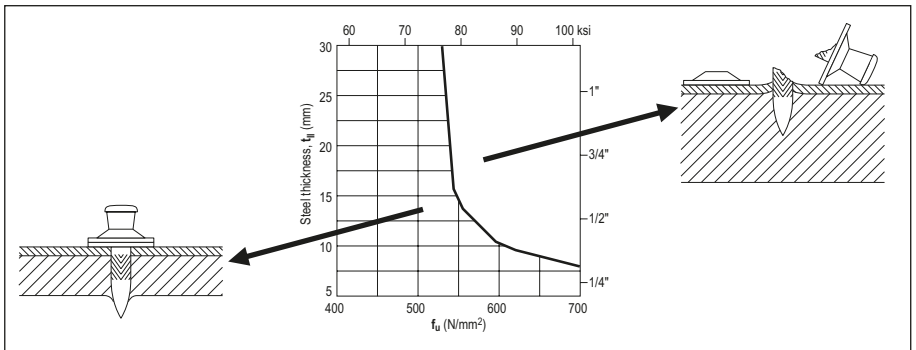

The application limit lines for long nails used to fasten wood to steel are plots of nail shank length L_s versus steel thickness t_{II} . Each line is valid only for one ultimate tensile strength of steel f_u . Attempts at working to the right of the limit line result in buckled nail shanks.

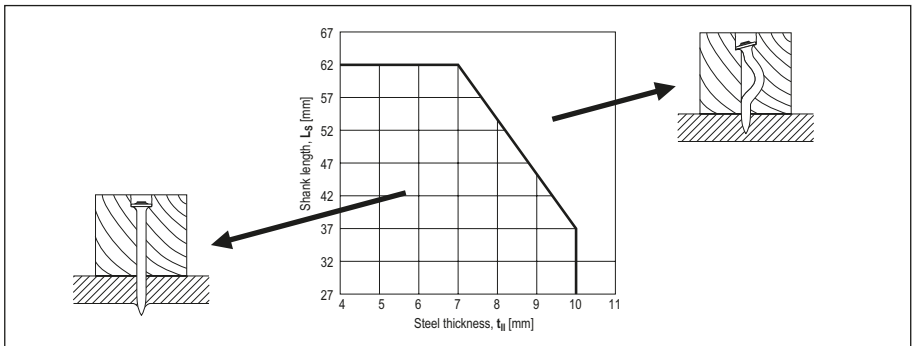

5.5 Thin steel base material

In the context of powder-actuated fastening, steel is considered thin when flange deformation during driving dominates fastener design. When the steel flange is thinner than about 6 mm [0.25"], flange deformation makes use of fasteners with a 4.5 mm [0.177"] shank diameter more difficult and switching to a 3.7 mm [0.145"] shank fastener leads to better results. Use of fasteners with tapered shanks and energy-absorbing washers improves performance and reliability.

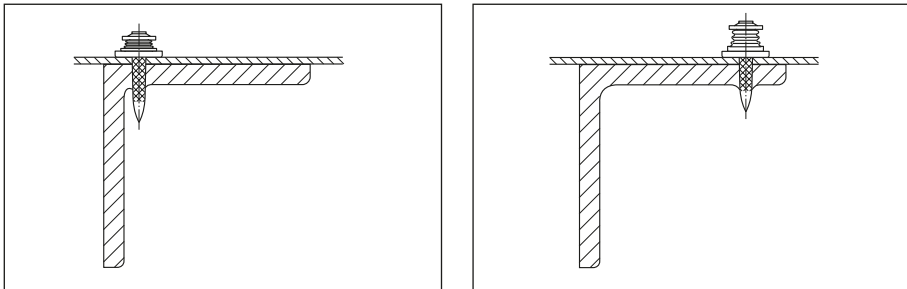

A fastener can penetrate into steel only when the steel (flange) develops a resistance greater than the force required for penetration. This implies the use of energy in excess of that required for penetrating into the steel. In fact, if the driving energy remains constant, fasteners placed closest to the web will be driven deepest. All siding and decking fasteners should have a mechanism to clamp the sheets down tightly over the entire range of allowable standoffs. This is especially critical for fasteners used for fastening to thin steel.

Obviously, under shear loading, failure of the base material is more likely with thin steel than with thick steel. When approving fastening systems for a project, it is important to consider whether the system has actually been tested with thin base steel or not.

Hilti's general recommendation for thin base steel fasteners is to place the fastenings within $b_x = 8 \cdot t_{fl}$ of the web.

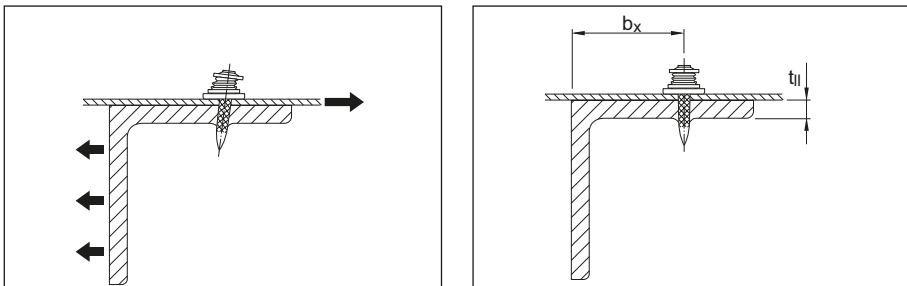

5.6 Types of load and modes of failure

5.6.1 Shear loads

The shear loads acting on siding and decking fasteners come from:

- Diaphragm action of the fastened sheets
- Forces of constraint (for example due to temperature changes)
- Self-weight of siding material

Testing

Shear testing of siding and decking fastenings is done using specimens made up of a strip of sheet metal fastened to a steel plate. Suitable, non-slip fixtures have to be used at either end. In some cases specimens are bent up at the sides to hinder eccentricity.

Failure of the fastened material

The load-deformation curves of shear tests with powder-actuated fasteners show a nearly ideal behavior. After an initial elastic phase during which the clamping force of the washers against the sheet metal is overcome, the sheet metal reaches its yield stress in an area where the fastener bears against it. Then the fastener shank cuts through the sheet metal until the end of the sheet is reached. The large area under the load-deformation curve represents energy absorbed, and this is what makes the fastening method ideal for diaphragms.

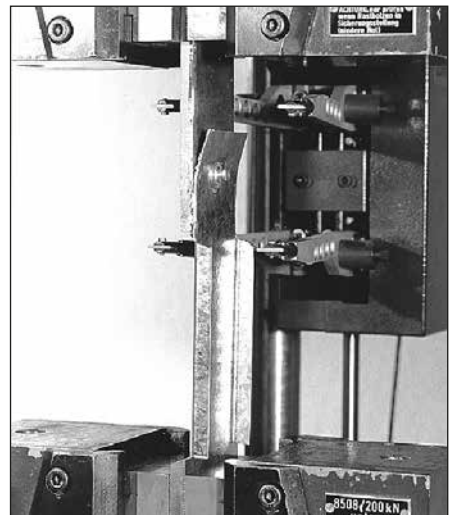

Failure of the base steel

If the thickness of the fastened sheet metal is large compared to the base steel thickness, bearing failure of the base material is a possible mode of failure.

Pull-out from the base steel

The unavoidable eccentricity in the shear test specimen leads to a tensile load component on the fastener. Thick fastened material and thin base material is also involved in this mode of failure. This failure mode is generally not governing for base material thickness of $t_{II} > 6$ mm.

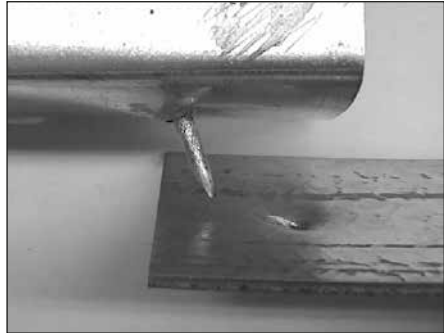

Fracture of the fastener

About 20 kN (4.5 kips) of force is required to shear the $\text{Ø} 4.5$ mm (0.177") shank of an X-ENP-19 L15 fastener. With about 2.5 mm (12 gauge) thick steel sheet as fastened material, a force of this magnitude could be possible. The force needed to break a $\text{Ø} 3.7$ mm (0.145") shank of an X-ENP2K-20 L15 fastener is about 13 kN (2.9 kips). This force can be generated with 1.5 mm (16 gauge) sheet steel. In practice, this failure mode is likely only where expansion joints are not provided to relieve forces of constraint from temperature differences.

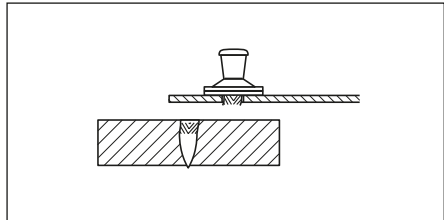

5.6.2 Tensile loads

The most common source of tensile loading on siding and decking fasteners comes from wind suction acting on the roof or wall cladding. In diaphragms, fasteners can be subject to tensile loads in situations where the combination of geometry and thickness of decking fastened leads to prying. In designs with very stiff decking and wide beams or unbalanced spans, prying can also be caused by concentrated loads.

Testing

Tensile testing of siding and decking fastenings is carried out using specimens made up of a trapezoidal-shaped piece of sheet metal fastened to a steel plate. Suitable, vice-like fixtures are used to grip the specimen. This is often referred to as a pull-over test because the common failure mode is the sheet pulling over the washers or the head of the fastener. If the sheet thickness fastened is increased so that pull-over does not govern, pull-out will be the failure mode.

Some fasteners like the Hilti X-ENP have a head that can be gripped and pulled out by a suitable fixture. With these fasteners, a pull-out test can still be done even if pull-over is the original mode of failure. This fastener type has the further advantage of allowing in-place fasteners on a jobsite to be tested.

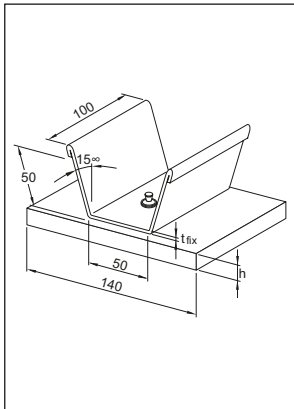

Pull-over test specimen

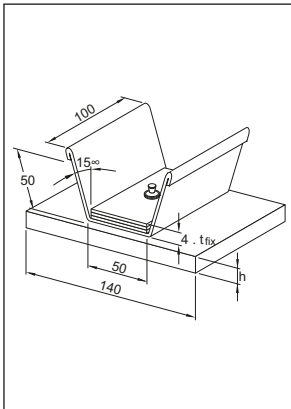

Pull-over test specimen with 3 extra layers to simulate end lap – side lap



Test setup

Sheet pull-over

In this failure mode, the sheet tears and is lifted up over the fastener head and washers. Depending on the sheet thickness and tensile strength, the washers may be bent up.

Washer pull-over

Another possible failure mode is that of the washers being pulled up over the head of the nail. Obviously, this happens when the sheet is somewhat stronger and /or thicker than when sheet pull-over occurs. This failure mode is also heavily dependent on fastener design.

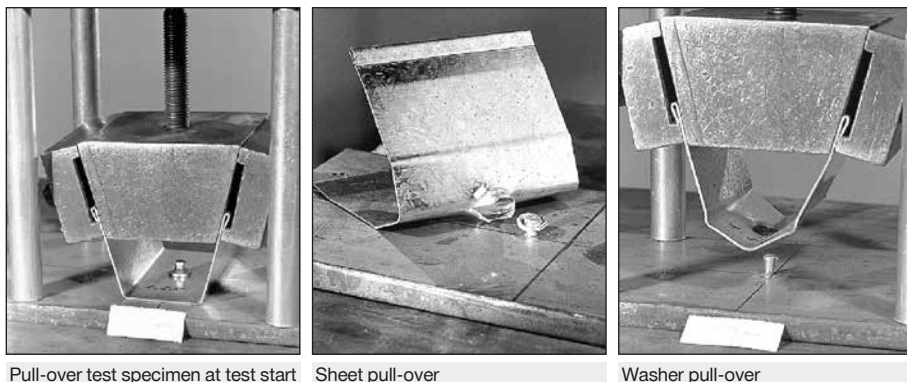

Pull-out from the base steel

As sheet thickness and number of layers is increased, this failure mode becomes more likely. For a properly driven **X-ENP-19 L15** pull-out from the base steel is not a likely mode of failure. The head and washer design of the **HSN 24** or **X-ENP2K-20 L15** fasteners can allow this failure mode, especially with multiple layers of sheets.

Fracture of the fastener

A force of more than 30 kN [6.7 kips] is required to break the $\varnothing 4.5$ mm [0.177"] shank of an **X-ENP-19 L15** fastener and, even if sheet or washer pull-over does not govern, pull-out strengths of this magnitude are not very common. This mode of failure will therefore hardly ever occur with these heavy-duty fasteners. The $\varnothing 3.7$ mm [0.145"] shank of an **X-HSN 24** or **X-ENP2K-20 L15** fastener may break at about 20 kN [4.5 kips] tension. Since these smaller fasteners will pull out at a force of 8 to 15 kN [1.8–3.3 kips], fractures due to tensile loads are rare. If fractured fasteners of this type are found on a jobsite, the most likely cause is that the application limit has been exceeded (the base steel is too hard and/or too thick for the pin).

Cyclic loading

Siding and decking nails used in wall and roof construction are subject to cyclic loading from wind suction. Cyclic load testing is carried out to determine characteristic resistance and allowable (recommended) loads. The requirements of the European Technical Assessment ETA prepared by DIBt (Deutsches Institut für Bautechnik) govern the design-relevant number of load repetitions (5,000) and the necessary safety factors. Notes in this regard are found on the corresponding product data sheets.

If the fastener will be subjected to a large number of load repetitions and fatigue, we recommend carrying out a design check according to the requirements of Eurocode 3 (or similar

code). Eurocode 3 gives the characteristic fatigue resistance and safety concept for steel construction. To carry out the check according to Eurocode 3 it is necessary to have a statistical analysis of test data obtained under the application conditions. Except for siding and decking fasteners, the applicable product data sheets limit the validity of recommended loads to predominantly static loading. If a design analysis has to be carried out for true fatigue loading, test data can be obtained from Hilti. Examples of such data are shown below.

X-EM8-15-14
(standard zinc-plated fastener)

The X-EM8-15-14 has a shank diameter of 4.5 mm and a hardness of HRC 55.5 ($f_u = 2,000$ MPa). The ΔF -N diagram shows the load range ΔF for a lower load of 0.05 kN. The individual test results are displayed as points and the curves show average and characteristic (95% survival probability) values. The failure mode was shank fracture or fracture in the M8 threading.

The recommended load for predominantly static loading is 2.4 kN. Comparing this value to the ΔF -N diagram will lead to the conclusion that X-EM8-15-14 fastenings designed for 2.4 kN static loading will survive a large number of load repetitions. The fastenings can be said to be robust, even when the actual loading turns out to be in part cyclic.

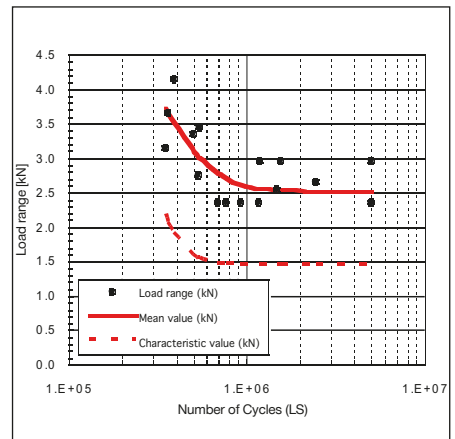

X-CRM8-15-12 (stainless steel fastener)

The X-CRM8-15-12 has a shank diameter of 4.0 mm and a minimum ultimate tensile strength of 1,850 MPa. The ΔF -N diagram shows the load range ΔF for a lower load of 0.05 kN. The individual test results are displayed as points. The failure mode was shank fracture or fracture just below the head of the stud.

The recommended load for predominantly static loading is 1.8 kN. Comparing this value to the ΔF -N diagram will lead to the conclusion that X-CRM8-15-12 fastenings designed for 1.8 kN static loading will survive a large number of load repetitions. The fastenings can be said to be robust, even when the actual loading turns out to be in part cyclic.

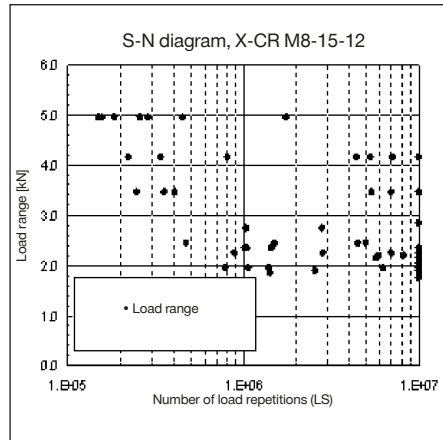

Mode of failure under cyclic loading

A major finding of cyclic loading tests is that the strength of a DX fastening subject to cyclic loading is not limited by failure of the anchorage. It is only when the number of cycles is very low – i.e. predominantly static loading – that nail pull-out is observed. The two schematic diagrams below show the relationship between failure mode and number of cycles. All tests show that the anchorage of DX fasteners in steel and in concrete is extremely robust with regard to resisting cyclic loading. Fasteners subject to a large number of load repetitions fracture in the shank, head or threading. A condition for obtaining this behaviour is that the fasteners are correctly driven. Fasteners that are not

driven deeply enough exhibit low pull-out strength and in a cyclic loading test may not necessarily fail by fracture.

Effect of number of cycles on failure mode DX fastener in steel (correctly placed)

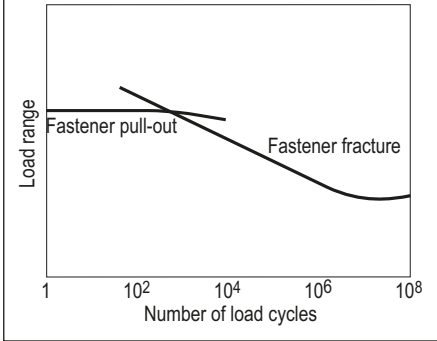

Effect of number of cycles on failure mode DX fastener in steel (incorrectly placed)

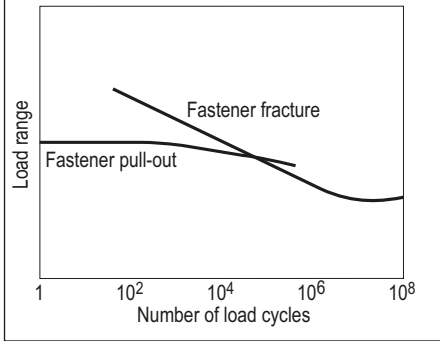

In older product information and data sheets, this basic suitability of DX fasteners for cyclic loading was emphasized by defining the recommended loads as cyclic recommended loads. At the time that this product information was assembled, a true safety concept for a strict check of DX fastenings subject to fatigue loading was not available. With Eurocode 3, this is today available. If a fatigue design analysis is carried out, it is important – as with static design – that adequate redundancy be provided.

Failure of the sheet

In cyclic load tests, failure of the steel sheet itself is common.

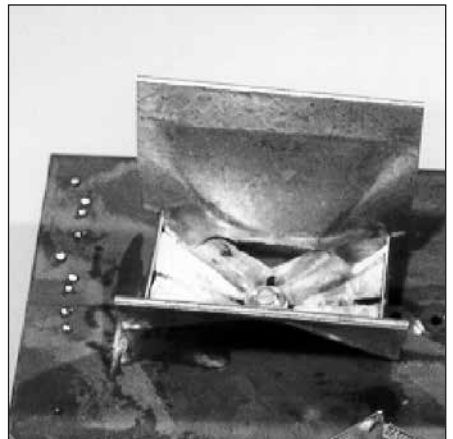

5.7 Effect of fasteners on structural steel

Driving powder-, gas-, or battery-actuated fasteners into a steel member does not remove steel from the cross-section, but rather displaces steel within the cross-section. It is therefore not surprising that tests like those described in following sections show that both drilled holes and screws, either self-drilling or self-tapping, reduce the strength of a cross-section more than powder-actuated fasteners.

The results of the tests can also be used to show that it is conservative to consider a powder-actuated fastener as a hole. This allows the effect of fasteners in a steel member subject to static loading to be taken into consideration.

Fatigue seldom needs to be considered in building design because the load changes are usually minor in frequency and magnitude. Full design wind and earthquake loading is so infrequent that consideration of fatigue is not required. However, fatigue may have to be considered in the design of crane runways, machinery supports, etc. The S-N curves resulting from fatigue tests of steel specimens with fasteners installed are also presented.

5.7.1 Effect on the stress-strain behaviour of structural steel

The effect that powder-actuated fasteners (PAF's) have on the stress-strain behaviour of structural steel was investigated in a systematic test programme using tensile test specimens containing PAF's, self-drilling screws and drilled holes. A control test was carried out using specimens without any holes or fasteners.

Series A:

- ASTM 607, grade 50
- Cross-section 3.42 x 74 mm [0.135 x 2.913"]
- X-EDNK22 powder-actuated fasteners, shank diameter 3.7 mm [0.145"]
- Drilled holes, diameter 3.7 mm [0.145"]
- Self-drilling screws, shank diameter 5.5 mm [0.216"]

Series B:

- S235 and S355 steel
- Cross-section 6 x 45 mm [0.236 x 1.772"]
- Powder-actuated fasteners, shank diameter 4.5 mm [0.177"]
- Drilled holes, diameter 4.5 mm [0.177"]

The figures below show representative stress-strain curves for the tests (the plotted stress is based on the gross cross-section). Note that the line for the powder-actuated fasteners follows the control test line more closely than the lines for drilled holes or self-drilling screws.

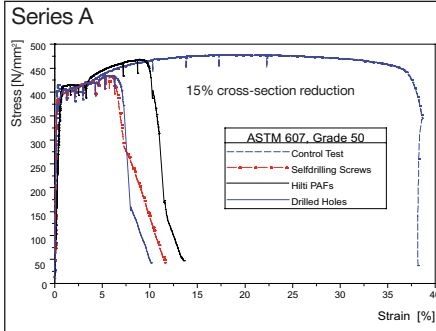

LOAD_DEFORMATION_SERIES_A

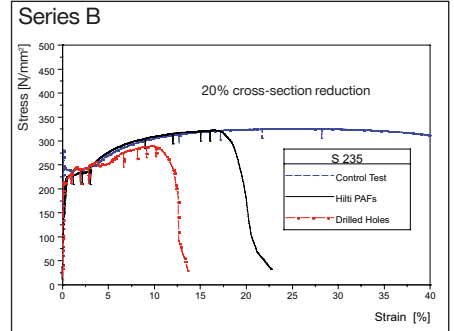

LOAD_DEFORMATION_SERIES_B

The test results were evaluated in terms of utilization as a measure of ultimate strength. Utilization is the ultimate load of a sample expressed as a percent of the ultimate load of the control test.

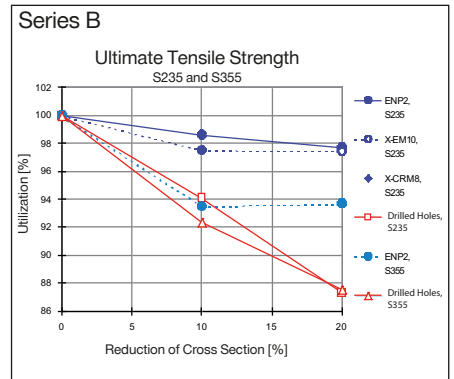
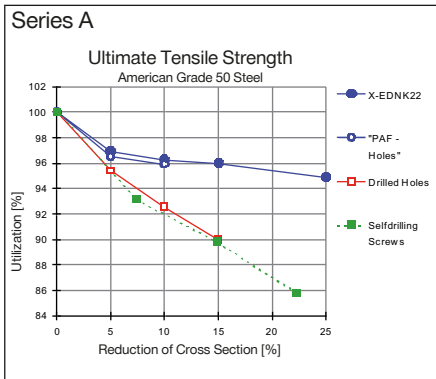

Graphs of the utilization versus cross-section reductions show that:

- The utilization for PAFs is clearly better than that of drilled holes or self-drilling screws.
- The hole left by a removed PAF has the same effect as when the PAF is left in place.
- Increasing the number of PAFs across a section from one to two or more has a proportionally smaller effect on utilization than placement of the first fastener.

More detailed information on the test program and findings is published in the paper

Powder-actuated fasteners in steel construction (and the referenced literature), published in the STAHLBAU-Kalender 2011 (Publisher Ernst & Sohn, 2011, ISBN 978-3-433-02955-8). English Reprints of the paper can be distributed per request.

5.7.2 Effect on the fatigue strength of structural steel

During the late 1970s and early 1980s, a fatigue testing program consisting of 58 tests with over 1,100 specimens was carried out at the University of Darmstadt in Germany. The reason for the research at that time was to support the use of powder-actuated fasteners for attaching noise-dampening cladding to railway bridges in Germany.

Parameters investigated in those tests are shown in following table:

Steel grade	Steel thicknesses	Stress ratio R	Imperfections
S 235 (St 37) / A36	6, 10, 15, 20, 26.5, 40, 50 mm	0.8, 0.5, 0.14, -1.0, -3.0	Fastener:
S 355 (St 52) / grade 50	[0.236, 0.394, 0.591, 1.043, 1.575, 1.969"]		- installed and pulled out, - inclined installation and pulled out - inclined installation

Loading conditions

The terminology and notation is shown in the illustration below.

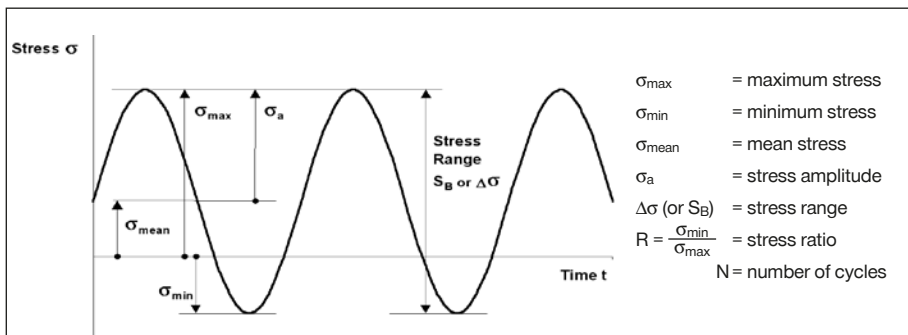

Fasteners tested

The primary fastener used in the tests was the Hilti ENP3-21 L15, the forerunner of the ENP2-21 L15. The difference is in the head shape, which has no effect on interaction with the base steel. Tests were also performed with the ENP2-21 L15, ENP3-21 D12 and the EM8-11-14 threaded stud, all of which have 4.5 mm diameter knurled shanks.

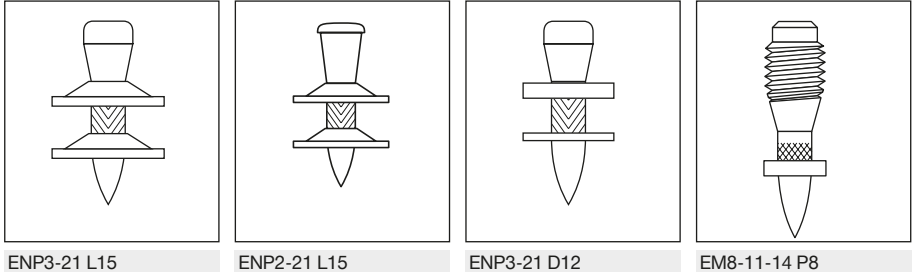

The results of the tests were evaluated by Niessner and Prof. T. Seeger from the University of Darmstadt in accordance with the provisions of Eurocode 3. An example plot of one test series is given at the right. The graph allows for a comparison with European fatigue categories 90 ($m = 3$) and 100 ($m = 5$) as well as American categories according to AWS-provisions.

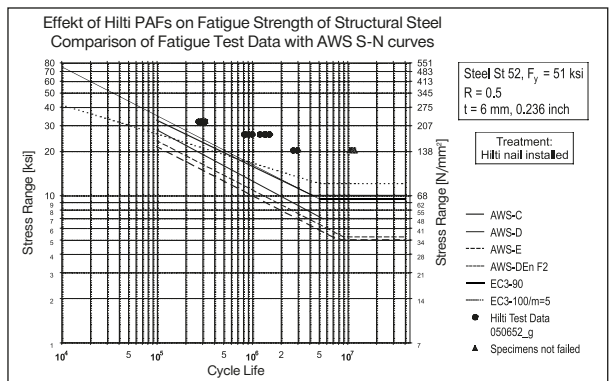

Conclusions

- The effect of driving a Hilti powder-actuated fastener on the fatigue strength is well known and predictable.
- The constructional detail “Effect of powder-actuated fasteners on base material” (unalloyed carbon steel) was evaluated by Niessner and Seeger from the University of Darmstadt in compliance with Eurocode 3.
- The EC 3 detail category 90 with $m = 3$ or the detail category 100 with $m = 5$ is alternatively applicable.
- Wrong fastener installations as popped out or inclined fasteners are covered. Piston marks in the base material due to wrong use of the tool without a fastener or notches due to fasteners failed during the installation have to be removed by appropriate measures.

More detailed information on the evaluation of the test data and the test program is published in the paper “Fatigue strength of structural steel with powder-actuated fasteners according to Eurocode 3” by Niessner M. and Seeger T. (Stahlbau 68, 1999, issue 11, pp. 941-948).

English reprints of this paper can be distributed per request.

6. Concrete base material

6.1 Anchoring mechanisms

The following three mechanisms cause a powder-actuated fastener to hold in concrete:

- Bonding / sintering
- Keying
- Clamping

These mechanisms have been identified and studied by analyzing pull-out test data and by microscopic examination of pulled-out fasteners and the concrete to fastener interface.

Bonding / sintering

When driving a fastener into concrete, the concrete is compacted. The intense heat generated during driving causes concrete to be sintered onto the fastener. The strength of this sintered bond is actually greater than that of the clamping effect due to reactive forces of the concrete on the fastener.

The existence of the sintered bond is demonstrated by examining pulled-out fasteners. The fastener surface, especially in the region of the point, is rough due to sintered-on concrete, which can only be removed by using a grinding tool.

When performing pull-out tests, the most common failure mode is breakage of the sintered bond between the concrete and the fastener, especially at and near the point.



Keying

The sintered material forms ridges on the fastener surface. These ridges result in a micro-interlocking of the fastener and the concrete.

This anchoring mechanism is studied by examining pulled-out fasteners under a microscope. As in the case of sintering, keying is primarily active in the region of the fastener point.



Mechanically cleaned point of a pulled-out DX fastener

Clamping

The compressibility of concrete limits the buildup of compressive stress around the driven fastener. This in turn limits the effectiveness of clamping as an anchoring mechanism.

Concrete failure

Concrete cone failure is occasionally observed when using a testing device with widely spaced supports. The fact that the concrete failed indicates that the fastener bond to the concrete was stronger than the concrete.

The tendency of stressed concrete to relax further reduces the compressive stress and hence the clamping effect. For these reasons, clamping of the fastener shank contributes only insignificantly to the total pull-out strength.

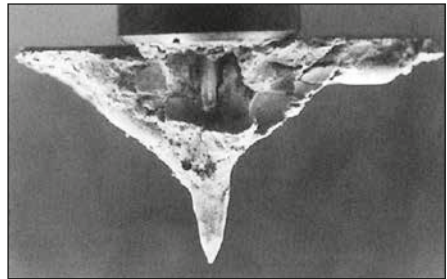

6.2 Factors influencing resistance to pull-out

Factors that can affect the pull-out strength of fastenings to concrete include:

- Depth of penetration into the concrete
- Concrete parameter (compressive strength, grain structure, direction of concrete placement)
- Distance to concrete edge and fastener spacing

Depth of penetration h_{ET}

Fasteners that are driven deeper typically have a higher resistance to pull-out. This relation is best shown by placing groups of fasteners with different driving energy and comparing the results for each group with the others. The result of such a test is shown in the graph at the right. Note that fastener driving failures were not considered in calculation of the average ultimate load, $N_{u,m}$.

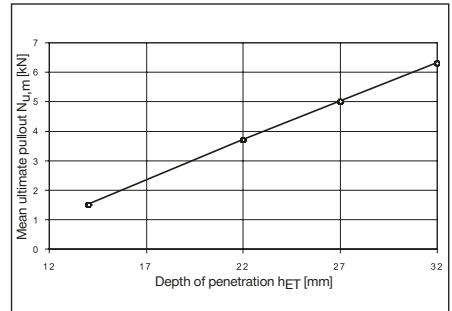

The value of increasing the depth of penetration in order to increase pull-out strength is limited by the increasing fastener driving failure rate. Provided that the penetration depth is the same, fastenings in concrete with a higher compressive strength hold better than fastenings in lower strength concrete. The ability to exploit this

characteristic is also limited by increased fastener driving failure rate with higher strength concrete.

As could be expected, the depth of penetration at which the failure rate is at a minimum decreases with increasing concrete strength.

Pull-out strength and fastener driving failure rate both increase with increasing penetration depth. The optimum depth of penetration is taken as the depth at which the yield in terms of pull-out strength begins to decrease. This is within a range of 18–32 mm depending on the grade and age of the concrete as well as the strength of the fastener.

$$\text{yield} = N_{u,m} \cdot \left(\frac{100 - p}{100} \right)$$

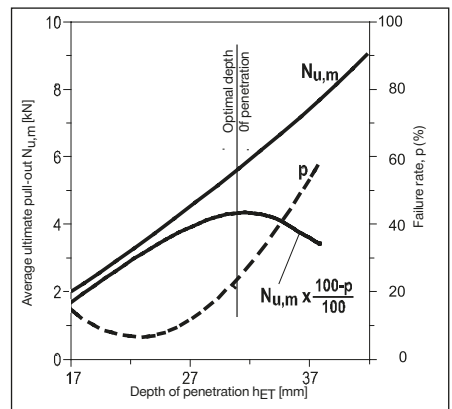

Concrete parameters

The concrete parameters (such as the type and size of concrete aggregates, type of cement and the location on top or bottom surface of a concrete floor) do affect the fastener driving failure rate, sometimes significantly.

Fastener driving failures are caused by the fastener hitting a hard aggregate, such as granite, located close to the concrete surface. A hard aggregate can deflect the fastener and in a severe case, the fastener may bend excessively,

leading to concrete fracture in a cone shape and no hold being obtained by the fastener.

In case of slight fastener bending, concrete spalling may occur at the surface. However, because pull-out strength is obtained mostly in the area of the fastener point, concrete spalling has little effect on the permissible load of the fastening.

Softer aggregates such as limestone, sandstone or marble may be completely penetrated when hit by the fastener.

Overhead fastening is usually associated with a higher rate of fastener driving failure than floor fastening. This is due to the distribution of the aggregates within the concrete. Large aggregates tend to accumulate at the bottom of a floor slab. At the top, there is a greater concentration of small aggregates and fines.

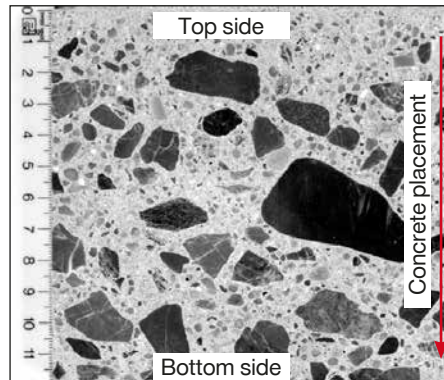

There are several possible ways of reducing the failure rate when powder-actuated fasteners are used for fastening to concrete. There are two basic ideas:

Pre-drilling the concrete (DX-Kwik)

By pre-drilling a very small hole (5mm diameter, 18 or 23 mm deep), the stresses are relocated to greater depth in the concrete. Fasteners placed with DX-Kwik are surrounded by a stress “bulb” located deep in the concrete. With this method, virtually no fastener driving failures occur.

one is to reduce concrete tensile stresses near the surface and the other is to delay the effect of these stresses.

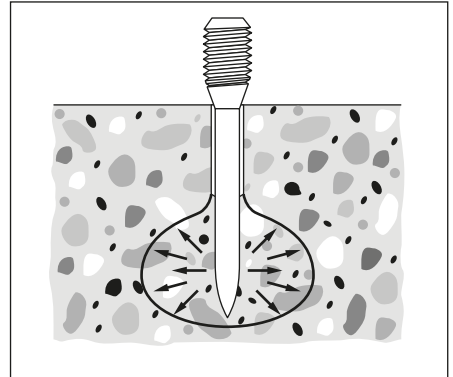

Spall stop fastener guide

A spall stop is a heavy steel fastener guide. Its weight and inertia counteract the stresses at the surface for a very short time. This allows redistribution of the stresses to other parts of the concrete.

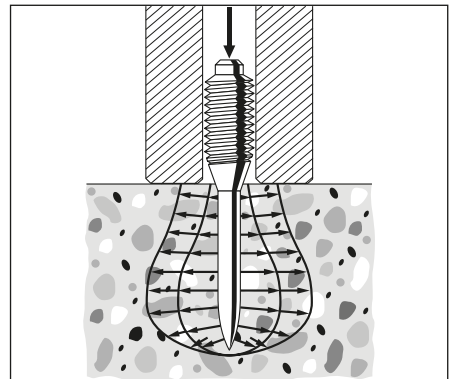

Changing from a long to a short fastener reduces the magnitude of the stresses and thus improves stick-rate.

Edge distance and fastener spacing

If fasteners are placed too close to the concrete edge, pull-out load capacity will be reduced. Minimum edge distances are therefore published with a view to reducing the effect edges have on pull-out strength. The corresponding data has been obtained from tests.

Additional provision is made for fastener spacing when positioned in pairs or where fasteners are placed in rows along a concrete edge.

These edge distances and spacing also have the purpose of helping to prevent concrete spalling and/or cracking due to fastening. However, spalling has generally only an insignificant influence on pull-out strength.

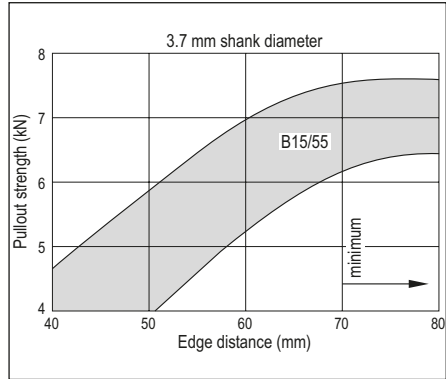

6.3 Effect of time on pull-out resistance

The effect of age on pull-out strength has been investigated in comprehensive tests. The main concern is, in fact, the effect of concrete relaxation in the area around the driven fastener.

This graph provides an overview of tests performed with DX-Kwik fasteners. Since standard DX fastenings have the same anchoring mechanism, this statement is also valid for standard DX fastenings. The test results indicate very strongly that relaxation of the concrete has no detrimental effect on the pull-out resistance of DX fastenings. The test data also shows that sintering and keying are the dominant anchorage mechanisms because they do not rely on friction between the fastener and the concrete.

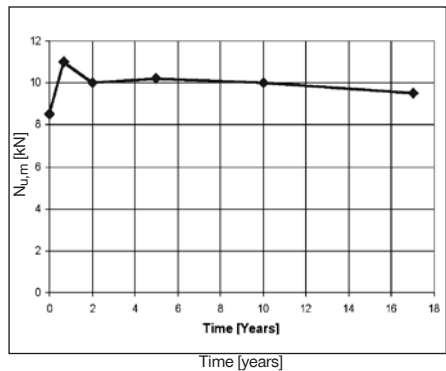

6.4 Effect on concrete components

Fastenings in the compression zone of the structure have no effect on concrete compressive resistance as long as detailed provisions on edge distance and spacing are complied with.

Fastenings in the tensile zone are subject to the following provisions:

- a. Installations on plain load-bearing components such as concrete walls or ceilings are generally possible without restrictions as the load-bearing behaviour of these components is only negligibly affected by the fasteners. The predominant condition is static loading. This statement is based on experimental investigations carried out at the Technical University of Braunschweig, Germany.
- b. Fastenings in reinforced concrete beams:

it has to be ensured that the main reinforcement steel will not be hit or penetrated by the DX fasteners. This measure of precaution is mainly founded on the reduction of the ultimate strain of the steel reinforcement. Exceptions are possible when the structural engineer responsible for design is consulted.

- c. Fastenings in pre-stressed concrete members:
it has to be ensured that the pre-stressing steel reinforcement or cables will not be hit or penetrated by the DX fasteners.

If the concrete is too thin, concrete will spall off on the rear surface. The minimum thickness of concrete depends on the shank diameter of the fastener used.

Fastener shank diameter d_{nom} (mm)	Minimum concrete thickness h_{min} (mm)
3.0	60
3.5 / 3.7	80
4.5	100
5.2	100

7. Masonry base material

7.1 General suitability

Direct fastening technology can also be used on masonry. The joints between bricks or blocks and the covering plaster layer on virtually all types of masonry (exception for

lightweight aerated concrete blocks) provide an excellent substrate for light-duty and secondary fastenings.

Suitability table: DX fastening on masonry

Masonry material	Unplastered masonry Fastenings in mortar joints* (joint width ≥ 10 mm)	Fastenings in masonry blocks or bricks	Plastered masonry Fastening in plaster (thickness ≥ 20 mm)
Clay brick			
solid	++	+	++
vertical perforated	++	--	++
horizontally perforated	++	--	++
Clay clinker			
solid	++	+	++
vertical perforated	++	--	++
Sand-lime block			
solid	++	++	++
perforated	++	++	++
hollow	++	++	++
Aerated concrete	--	--	--
Lightweight concrete			
solid	++	-	++
hollow	++	-	++
Hollow concrete	++	+	++
Slag aggregate			
solid	++	-	-
perforated	++	-	++
hollow	++	-	++
++ suitable	+ limited suitability	- not fully investigated	-- not suitable

*) Joints must be completely filled with mortar

The above table is based on laboratory and field experience. Because of the wide variety of types and forms of masonry in use worldwide, users are advised to carry out tests on site or on masonry of the type and form on which the fastenings are to be made.

8. Temperature effects on the fastening

8.1 Effect of low temperatures on fasteners

Steel tends to become more brittle with decreasing temperature. Increased development of natural resources in Arctic regions has led to the introduction of steels that are less susceptible to brittle failure at subzero temperatures. Most siding and decking fasteners are used to fasten the liner sheets of an insulated structure and are not exposed to extremely low

temperatures during service. Examples of situations where the fastenings are exposed to extremely low temperatures during their service life are:

- Fastenings securing cladding in single-skin construction
- Construction sites left unfinished over a winter
- Liner sheets in a cold-storage warehouse

Low temperature embrittlement

The susceptibility of fasteners to become brittle at low temperatures can be shown by conducting impact bending tests over a chosen temperature range. The ability

of Hilti drive pins to remain ductile over a temperature range from +20°C to -60°C is shown clearly by the fact that the impact energy required remains nearly constant throughout this temperature range.

Impact bending test - DSH57 (4.5 mm diameter, HRC 58 ± 1)

Temperature		Impact energy (foot-pounds)			Impact energy (Joules)		
°F	°C	minimum	maximum	mean	minimum	maximum	mean
68	20	35.1	>36.1	>36.1	47.6	>48.9	>48.9
32	0	35.8	>36.1	36.0	48.5	>48.9	48.8
- 4	-20	31.4	>36.1	34.3	42.6	>48.9	46.5
-40	-40	34.4	36.5	35.7	46.6	49.4	48.4
-76	-60	35.6	36.2	35.9	48.2	49.0	48.7

Impact bending test - X-CR (4.0 mm diameter)

Temperature		Impact energy (foot-pounds)			Impact energy (Joules)		
°F	°C	minimum	maximum	mean	minimum	maximum	mean
68	20	14.8	17.0	15.9	20	23	21.6
32	0	17.7	15.5	18.3	24	21	24.8
- 4	-20	14.8	15.9	15.5	20	21.6	21.0
-40	-40	16.2	17.9	16.8	21.9	24.2	22.8
-76	-60	14.2	15.6	15.1	19.2	21.1	20.5

Impact bending test - X-CR (3.7 mm diameter)

Temperature		Impact energy (foot-pounds)			Impact energy (Joules)		
°F	°C	minimum	maximum	mean	minimum	maximum	mean
68	20	11.5	14.8	13.2	15.6	20.0	17.9
32	0	12.9	16.3	15.1	17.5	22.1	20.4
- 4	-20	13.1	15.8	14.7	17.8	21.4	19.9
-40	-40	14.2	15.8	14.8	19.2	21.4	20.1
-76	-60	12.3	15.0	13.7	16.7	20.3	18.6

Tests conducted according to DIN EN 10045 parts 1-4

Distance between supports = 22 mm

The symbol ">" indicates no breakage of the specimens. In the other cases, about 50% of the specimens suffered breakage.

8.2 Effect of low temperatures on fastenings to steel
Effect of low temperatures on pull-out strength

Tests show that very low temperatures tend to increase pull-out strength with both standard zinc-plated fasteners and with the stainless steel. The results of two tests are summarized below. The fasteners were

driven at room temperature and tested at -40°C to -70°C . A control sample was tested at 20°C . Explanations for the greater strength at low temperatures include increase in the strength of the zinc that is displaced into the knurling as well as increased strength of the fusing at the point of the fastener.

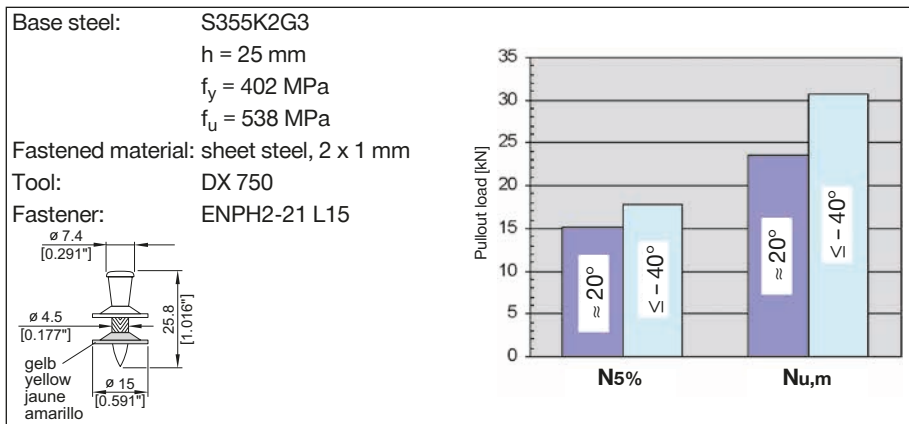

Base steel : $h = 20 \text{ mm}$
 $f_u = 450 \text{ MPa}$
 Fastened material : none
 Tool : DX 750 G
 Fastener : X-CRM8-15-12 FP10

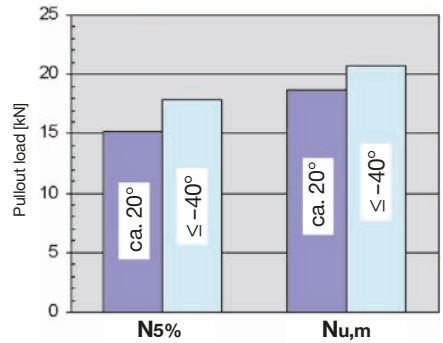
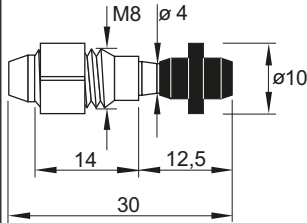

Two facts stand out from this testing:

- Pull-out strength increased as temperature decreased
- Pull-out from the base steel was the only mode of failure observed. There were no fractures!

8.3 Fire rating of fastenings to steel

Standard zinc-plated, thermally hardened steel fasteners

When subjected to high temperatures as in a fire, both powder-actuated fasteners

and structural steel lose strength. Data for standard zinc-plated, thermally hardened fasteners and structural steel are plotted in the graph below.

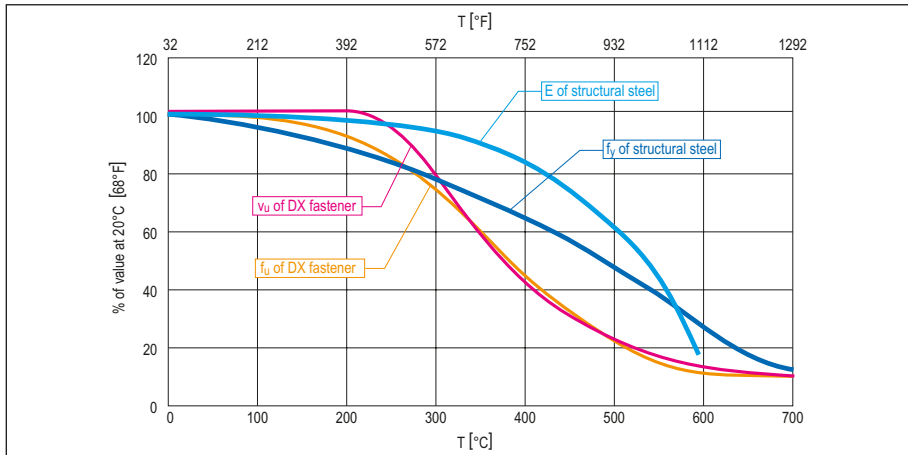

Up to about 300°C [572°F], the strength loss for DX fasteners is roughly proportional to the yield strength loss of structural steel. At 600°C [1112°F], DX fasteners have about 12% of their 20°C [68°F] strength left and structural steel about 26%. Since DX fasteners obtain their high strength through a thermal hardening process, the loss in strength at elevated temperatures is proportionally greater than for structural steel.

The relevance of different strength losses has to be evaluated in the context of the proportion of the material strengths that are actually exploited in a design. In a design calculation, it is conceivable that some steel will actually reach yield stress.

The material strengths of an X-ENP-19 L15 fastener is 30 kN [6.74 kips] in tension and 18.6 kN [4.18 kips] in shear respectively. The recommended working load in tension and shear for an X-ENP-19 L15 16 gauge (1.5 mm) fastening is 4.7 kN [1.057 kips] in tension and 4.6 kN [1.034 kips] in shear, respectively. Thus, the exploitation of the X-ENP-19 L15 strength at about 600°C is only 16 to 25% compared to about 74% for structural steel.

In a fire, powder-actuated fastenings will not be the governing factor. If the fire protection requirements permit the use of structural steel, then powder-actuated fastening can also be used without negative impact on fire protection.

CR500 stainless steel fasteners Hilti X-CR/X-CRM fasteners are much more resistant to loss of strength at high temperatures than standard fasteners. The effect of temperature on ultimate shear stress of stainless fasteners made of CR500 was determined in single lap joint shear

tests by the Swiss Federal Laboratory for Materials Testing and Research (EMPA). The results are plotted in the diagram below. This test was done by shearing 4.5 mm diameter fasteners that were inserted in steel plates with 4.6 mm diameter drilled holes.

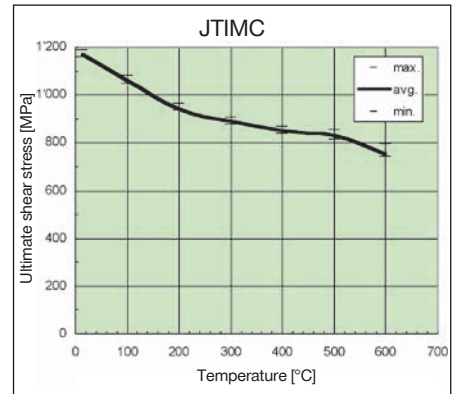
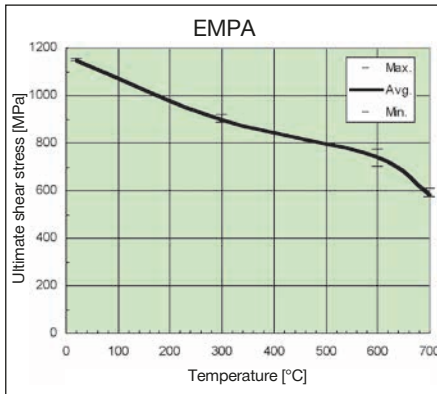

In Japan, similar tests were carried out by JTICM (Japan). These tests were done by driving a 4.5 mm diameter X-CR nail through a 6 mm steel plate into a second 6 mm thick steel plate and shearing the two plates. From the graph it is apparent that the results are nearly the same.

At 600°C, the CR500 material has 64% of its 20°C shear strength left. By comparison, standard fasteners have only 12% and structural steel only about 26%. The excellent fire resistance of the CR500 material alone justifies its use for some applications.

8.4 Fire rating of fastenings to concrete

Concrete is weakened and damaged by fire but not as quickly as steel. In ISO-standard fire tests conducted with DX-Kwik fastenings at the Braunschweig Technical University in Germany the only failure mode was fracture of the nails.

The actual test data are shown in the table below:

X-DKH 48 P8S15 DX-Kwik fastener, 4.0 shank

Tested in crack width ΔW (mm)	Tensile load, F (N)	Fire resistance/ time to failure (minutes)	Failure mode
0.2	250	103	Nail fracture
0.2	250	107	Nail fracture
0.2	350	73	Nail fracture
0.2	350	91	Nail fracture
0.2	500	56	Washer pullover
0.2	500	92	Nail fracture
0.2	500	93	Nail fracture

The stress in the fasteners at failure was calculated and plotted so that a plot of stress versus time resulted.

The characteristic failure stress curve from the previous graph can be used to calculate the failure load for various shank diameters with exposure to fire of different lengths of time. The calculated failure loads for 3.7, 4.0 and 4.5 mm shank diameter fasteners after 60, 90 and 120 minutes exposure to fire are shown in the table below.

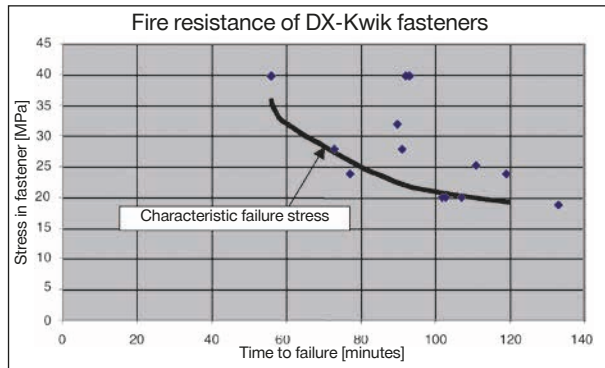

Failure loads for various shank diameters and fire exposure times

Shank diameter (mm)	Fire exposure time and failure stress		
	60 minutes	90 minutes	120 minutes
	32.1 MPa	22.3 MPa	19.1 MPa
3.7	340 N	240 N	200 N
4.0	400 N	280 N	240 N
4.5	510 N	350 N	300 N

This table can be used to determine recommended loads for the ISO fire resistance required.

9. Design concepts

The recommended working loads N_{rec} and V_{rec} are suitable for use in typical working load designs. If a partial factor of safety design method is to be used, the N_{rec} and V_{rec} values are conservative when used as N_{Rd} and V_{Rd} . Alternatively, the design resistance may be calculated from the recommended loads by multiplying by the factor 1.4, which considers the uncertainties from the load on the fasteners. Exact values

for N_{Rd} and V_{Rd} can be determined by using the safety factors where given and or reviewing test data. Based on cyclic tests it can be stated that DX fastenings can be said to be robust, even when the actual loading turns out to be in part cyclic. Design loads (characteristic strength, design resistance and working loads) for the **X-HVB** shear connector are listed and specified per design guideline.

The designer may encounter two main fastening design concepts:

Working load concept

$$N_S \leq N_{rec} = \frac{N_{Rk}}{\gamma_{GLOB}}$$

where γ_{GLOB} is an overall factor of safety including allowance for:

- errors in estimation of load
- deviations in material and workmanship

and N_S is in general a characteristic acting load.

$$N_S \equiv N_{Sk}$$

Partial factors of safety

$$N_{Sk} \cdot \gamma_F = N_{Sd} \leq \frac{N_{Rk}}{\gamma_M} = N_{Rd}$$

where:

γ_F is a partial factor of safety to allow for errors in estimation on the acting load and

γ_M is a partial factor of safety to allow for deviations in material and workmanship.

The characteristic strength is defined as 5 % fractile:

$$N_{Rk} = N_{u,m} - k \cdot s$$

The k factor is a function of the sample size and the accuracy required. The characteristic strength of fastenings to concrete is determined based on a 90% probability while fastenings to steel are based on a 75% probability.

Structural analysis of the fastened part (e.g. roof deck panel or pipe hung from a number of fastenings) leads to calculation of the load acting on a single fastening, which is then compared to the recommended load

(or design value of the resistance) for the fastener. In spite of this single-point design concept, it is necessary to ensure adequate redundancy so that failure of a single fastening will not lead to collapse of the entire system. The old saying “one bolt is no bolt” can also be applied to DX fastening.

For standard DX fastenings on concrete, a probability-based design concept based on multiple fastening is applied in order to allow for fastener driving failures and the large scatter in holding power observed. This concept applies to tensile as well as shear loading and is described in following chapter.

10. Determination of technical data for fastening design

The determination of technical data is based on the following tests:

- Application limits
- Tensile tests to determine pull-out and pull-over strength
- Shear tests to determine bearing capacity of the attached material and the base material.

These tests are described in more detail in the sections “Steel and other metal base material” and “Concrete base material”.

10.1 Fastenings to steel

Failure loads in tension and in shear are normally distributed and the variation coefficient is $< 20\%$. The test data for each test condition are evaluated for the average and characteristic values. The characteristic value is based on the 5% fractile for a 75% probability.

The application range of the fastener is determined by application limit test where fasteners are set on steel plates of thickness ranging from the minimum recommended thickness $t_{l,min}$ to full steel (≥ 20 mm) and varied plate strength.

The application limit is reached when 1 shear off failure with 30 fasteners tested occurs, or if a detrimental effect on the load values (resistance) occurs.

Due to the small scatter in failure loads fastenings in steel can thus be designed as single points, although good engineering practice should be kept in mind. System redundancy must be always ensured.

10.2 Profile sheet fastenings

In addition to general fastenings to steel, specific data applies to profile sheet fastenings:

Cyclic loading

Profile sheet fastenings are subjected to repeated loading to simulate wind effects. Cyclic pull-through tests are additional optional tests where the failure load at 5,000 cycles is determined.

The design value of the pull-through resistance for repeated wind loads is the design value of the static pull-through resistance multiplied by a reduction factor of α_{cycl} .

- If cyclic tests are carried out:

$$\alpha_{cycl} = 1.5 (N_{Rk,cycl} / N_{Rk,sta}) \leq 1$$

(The factor 1.5 takes the different safety levels for fatigue and predominately static design into account)

- If no cyclic tests are carried out:

$$\alpha_{cycl} = 0.5$$

Sheet bearing capacity

Profile sheet fastenings may be subjected to shear stresses from building movements or thermal dilatation of the sheets. Tests are undertaken to prove the suitability of the fastenings to support the deformations imposed.

For this, shear tests are carried out using a substrate of the minimum and maximum thickness and 2 layers of profile sheet of the thickness specified.

The fastening is considered suitable if an elongation of 2 mm is achieved without the sheet coming loose or showing an excessive reduction in pull-out load capacity. In this case, no consideration of forces of constraint is required since sufficient ductility is provided by the fastening due to hole elongation.

Standardization

The pull-over strength of profiled sheet fastenings is given with reference to core sheet thickness. Ultimate load data is standardized to the minimum sheet thickness and strength as specified by the relevant sheet standard. The correction applied is as follows:

$$F_{U'} = F_U \cdot \frac{t_{min}}{t_{act}} \cdot \frac{f_{u,min}}{f_{u,act}}$$

10.3 Fastenings to concrete (standard DX / GX / BX)

The failure loads in tension and shear show a large scatter with a variation coefficient of up to 60%. For specific applications, fastener driving failures may be detected and the fasteners replaced (e.g. threaded studs). For others, however, detection may not be possible (e.g. when fastening wooden battens) and this must be taken into consideration.

The design resistance is therefore determined for:

- failure loads without considering fastener driving failures
- failure loads considering a 20% rate of fastener driving failure

Evaluation of technical data and design according to the single point design approach based on fractiles and a safety factor is not feasible for such systems. The characteristic value would become zero at a variation coefficient of about 50%.

The evaluation of the data and the determination of the design resistance is therefore based on a multiple fastening, i.e. a redundant design, in which the failure probability not of a single, but of a number of fasteners supporting a structure is calculated. By this system, load may be transferred between the fasteners, if slip or failure of one or more of the fasteners occurs.

Test data

The test data for the fastener is consolidated to form a master pullout load distribution.

Static system

Two static systems are examined

- A suspended beam allowing unrestrained flexure of the beam
- A beam directly attached to the surface, which shows restrained flexure

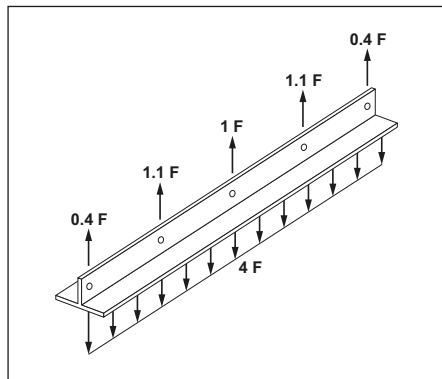

Calculation method

The calculation method used is the Monte Carlo method, by which holding values taken stochastically from the master distribution are attributed to the individual fasteners of the system and the system is checked to determine whether the imposed line load can be supported. By performing a large number of such simulations, statistical information on the failure probability of a system under a given line load is obtained. Hidden setting failures can also be considered with this method.

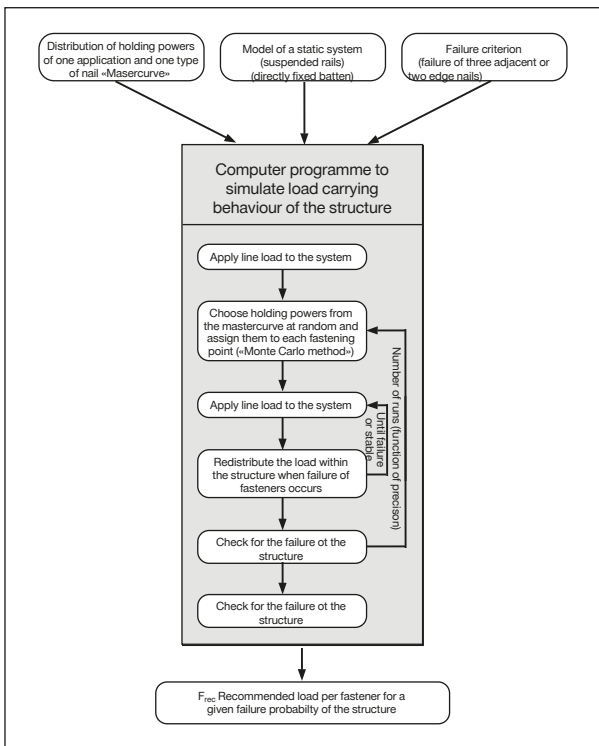

Design parameters

The design is based on the following parameters:

- Failure probability: $1 \cdot 10^{-6}$
- Number of fasteners: 5
- Line load uniformly distributed
- Failure criterion: 2 edge or 3 central fastenings

The result is expressed in recommended load per fastening.

Effect on a fastening design

The overall condition for a fastening design in practice is that redundancy of the complete system has to be ensured. The effect of the Monte Carlo approach on a design is illustrated with two examples below.

Example:

Fastening of a plumbing with five ceiling hangers.

1. Due to the stiffness (EI) of the plumbing a redistribution of the dead load (g) to the remaining hangers is given in case of two neighbouring hangers failing.

(Fixing of each hanger with one nail is sufficient.

2. The plumbing is not stiff enough to redistribute the dead load to the neighbouring hangers in case of one fastener failing.

(Each hanger has to be fastened with five nails.

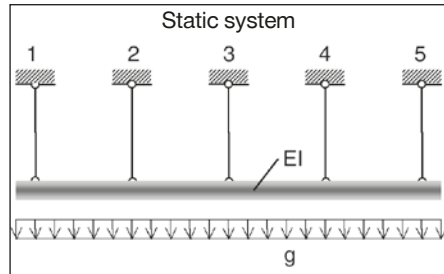

10.4 DX fastenings to concrete (DX-Kwik)

Failure loads in tension and shear are log-normally distributed and the variation coefficient is <20 %. The test data is evaluated to yield the 5 % fractile based on a 90% probability. The recommended working loads are obtained by applying a global safety factor of 3 for tension and shear.

The determination of technical data for cracked concrete (tensile zone) is based on tensile tests. Shear tests in cracked and uncracked concrete give similar results and are therefore not performed.

Failure loads in cracked concrete show a higher variation coefficient. Test data is also evaluated to yield the 5% fractile. The recommended load for the tensile zone is taken as the smaller of the following values:

- $N_{rec} = N_{RK} / \gamma_{GLOB}$ $\gamma_{GLOB} = 3.0$ for 0.2 mm crack width
- $N_{rec} = N_{RK} / \gamma_{GLOB}$ $\gamma_{GLOB} = 1.5$ for 0.4 mm crack width.

The application range of the fastener is determined by application limit test where fastenings are made on concrete of varying strength and age according to the application conditions specified (pre-drilling and setting). The attachment height is kept at the lower end of the range specified. The application limit is reached, if the failure rate exceeds 3% or the pull-out values strongly deviate from a lognormal distribution. The sample size is 30 per condition.

10.5 Fastener design in the USA and Canada

Testing of powder-actuated fasteners is carried out according to the ICC-ES AC 70 acceptance criteria and ASTM E 1190 standard test method. The test procedure covers tensile and shear testing in steel, concrete and masonry.

The determination of the allowable (recommended) load is shown below. The recommended working load is derived from the test data by taking the average failure load or the calculated characteristic load divided by a global safety factor.

$$P_a = V_a = F_{all} = \frac{F \cdot R \cdot R_f}{\Omega} \quad (3-1)$$

where:

- F = Average ultimate load [lbf (N)] of the test series.
- Ω = Safety factor determined in accordance with Section 3.3.2.
- R = Most severe base material reduction factor determined in accordance with Section 3.3.3.1, 3.3.3.2, or 3.3.3.3, as applicable.
- R_f = Fastener based reduction factor, determined in accordance with Section 3.3.3.4, as applicable.

Exception: When testing satisfies the alternate sample size described in Section 8.1 of ASTM E1190 (the COV from ten tests is 15 percent or greater), F shall be taken as the lowest ultimate load of the ten tests and Ω shall be taken as 5.

3.3.2 Safety Factor, Ω : The safety factor shall be determined using Equation 3-2.

$$\Omega = \frac{3.5}{(1 - 2COV)} \geq 5 \quad (3-2)$$



Part 2:

Fastener selection guide

1. Selecting the right fastener

These considerations are used to determine suitable powder-actuated (DX), gas-actuated (GX) or battery-actuated (BX) fasteners for a given application.

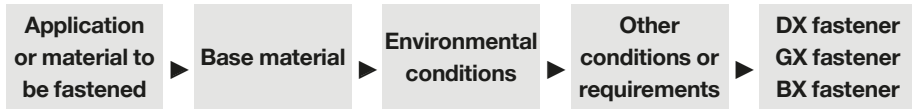

Detailed technical information for the selected fastener family can be found on its product data sheet on the displayed pages.

For some applications, two or more fastener families are listed as suitable. The final selection is influenced by specific application requirements, available tools and technical data can be found on the product sheets.

Regional differences in building methods, materials, trade preferences, available tools, etc. also influence fastener selection. Therefore, designers and specifiers are advised to consult the local Hilti website and make use of the local Hilti technical advisory service.

1.1 Selection based on the type of concrete

What determines nail performance

Hilti Direct Fastening systems are designed to achieve maximum performance in a wide range of applications. But there is a large variety of nails types and elements for various direct fastening concrete applications. To select the appropriate nail for a given application, some important influencing parameters need to be considered:

- a) concrete properties,
- b) nail design and features
- c) fastening system used
- d) nail embedment depth
- e) fastening tools and energy level

a) Concrete properties

A nail penetrating concrete needs to create a hole for the shank by crushing and compacting the concrete and also needs to withstand hitting hard aggregates. The resulting holding value achieved by the nail is linked to its diameter and embedment depth.

High penetrability and compactability lead to high stick rates and holding values.

Note: Concrete compressive strength alone is not decisive for nail performance.

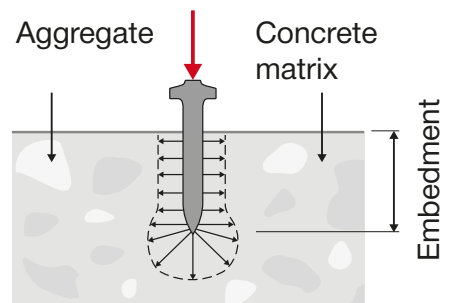

Four concrete types can be roughly distinguished:

<div style="background-color: #ccc; border-radius: 50%; width: 40px; height: 40px; display: flex; align-items: center; justify-content: center; margin: 0 auto;">S</div> <p>Soft</p>	<ul style="list-style-type: none"> Low to medium compressive strength, $f_{c, \text{cube}} \approx 10+35$ MPa Soft and small size aggregates Concrete age earlier than 28 days <p>Example:</p> <ul style="list-style-type: none"> Lightweight concrete, young concrete Compressive strength class C12/15 acc. to EN 206
<div style="background-color: #ccc; border-radius: 50%; width: 40px; height: 40px; display: flex; align-items: center; justify-content: center; margin: 0 auto;">M</div> <p>Medium</p>	<ul style="list-style-type: none"> Medium compressive strength, $f_{c, \text{cube}} \approx 25+45$ MPa Average hard and small to medium size aggregates <p>Example:</p> <ul style="list-style-type: none"> Normal weight concrete for interior floor slabs Compressive strength class C20/25 acc. to EN 206
<div style="background-color: #ccc; border-radius: 50%; width: 40px; height: 40px; display: flex; align-items: center; justify-content: center; margin: 0 auto;">T</div> <p>Tough</p>	<ul style="list-style-type: none"> Medium to high compressive strength, $f_{c, \text{cube}} \approx 45+65$ MPa Average hard and medium size aggregates, e.g. limestone, pit gravel, some granite <p>Example:</p> <ul style="list-style-type: none"> Normal weight concrete in historic buildings Compressive strength class C50/60 acc. to EN 206
<div style="background-color: #ccc; border-radius: 50%; width: 40px; height: 40px; display: flex; align-items: center; justify-content: center; margin: 0 auto;">V</div> <p>Very tough</p>	<ul style="list-style-type: none"> High compressive strength, $f_{c, \text{cube}} > 65$ MPa Hard and medium size aggregates, e.g. quartz, basalt, greywacke <p>Example:</p> <ul style="list-style-type: none"> Ultra-high-performance concrete Compressive strength class C70/80 acc. to EN 206

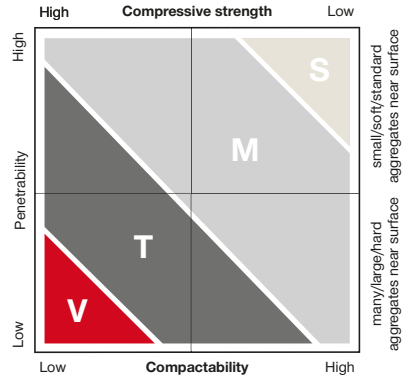

Note: $f_{c, \text{cube}}$ = compressive strength of concrete cube (150 mm edge length)

b) Nail design and features

Penetrability and compactability, i.e. a nail's ability to penetrate and compact the concrete, are strongly influenced by three nail design features:

Point type

The point type and the reduction of the diameter in the area of the tip allows a significantly improved penetration behaviour in concrete.



Nail geometry

Length and diameter also affect how easily the nail penetrates the concrete.

Nail hardness

A harder nail is easier to drive into tougher concrete. However, if the nail is too hard, it can break instead of bending when it hits a hard aggregate in the concrete.

c) Fastening systems used

Hilti Direct Fastening Systems help to ensure that nails are correctly driven by achieving maximum nail perpendicularity, good nail guidance and thorough use of the appropriate driving energy.

Perpendicularity

Hilti Direct Fastening tools help to keep nails perpendicular to the working surface, thus reducing failures caused by nails driven at an angle. During the fastening process, Hilti Direct Fastening tools have to be maintained perpendicular to base material as much as possible. Please refer to the respective instructions for use and tool operation manuals for details.

Nail guidance

Due to excellent nail guidance in the tool and the use of solid washers, the nail leaves the tool at the intended angle.

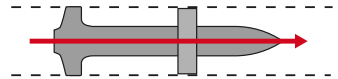

d) Nail embedment depth

Another factor that influences nail performance is embedment depth. A nail that can be driven deeper in the concrete has the ability to achieve higher load performance. However, there are two side effects if a nail needs to be driven deeper.

- stick rate can decrease
- higher driving energy is required as the nail must penetrate further into the concrete

e) Fastening tools and energy levels

Nail driving energy released by a Hilti tool is precisely controlled to help achieve the desired embedment depth reliably.

Powder-actuated tools (DX)

Embedment depth of a nail can be influenced by selecting the right cartridge color and adjusting the power setting on the tool, where applicable.

Hence, it is crucial to understand how the different tools in combination with the various cartridges, vary in terms of energy generation. Use that knowledge to pick the right tool and the right cartridge to help achieve the required embedment depth and reach the optimum nail load performance.

Gas-actuated tools (GX)

Embedment depth can be influenced by adjusting the slider in the front of the tool to “+” or “-” position.

Battery-actuated tools (BX)

Embedment depth can be influenced by selecting a different nail length.

Choice of a nail for use on concrete

Three main factors define the nail selection on concrete:

- speed of installation
- stick rate
- holding values

Speed of installation

All system technologies, powder-actuated tool (DX), gas-actuated tool (GX) and battery-actuated tool (BX) offer a very high installation speed.

Stick rate

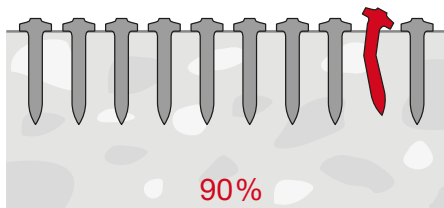

The stick rate indicates the percentage of nails that are driven correctly to carry a load.

Generally, stick rate can often be improved by combination of:

- using shorter nails
(on condition that required load can still be achieved with shorter embedment)
- selecting nails from a higher nail class
(nail classes are described later in this chapter)
- using more energy by combination of tools, cartridges and energy setting
- using different technologies and nails from a higher nail class, i.e. switching from gas-actuated (GX) or battery-actuated tools (BX) to powder-actuated tools (DX)
- pre-drilling, see chapter Kwik

Holding values

Holding values provide a measure of a nail's load-bearing capacity which ensures the reliable use in practical applications, consistent with their diameter and embedment depth. Nails are typically subject to static or quasi-static loads, which act as tensile, shear or combined tensile and shear forces.

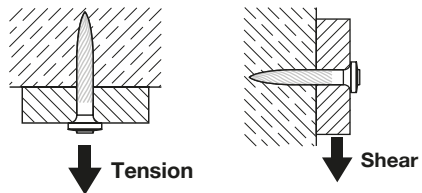

Nail types

Different nails have been developed for various applications and conditions.

Medium duty Class I and II nails are used for load-sensitive high performance applications in tough concrete, while medium duty Class III nails are for versatile use in soft, medium and tough concrete. Medium duty Class I, II and III nails are generally fastened with powder-actuated tools (DX).

Light duty Class IV and V nails, generally fastened with gas-actuated (GX) and battery actuated tools (BX), are typically used for applications that have lower load requirements, hence requiring shorter embedment depth. In general, Class V nails present the most economical solution as they are the least costly.

Cost is directly related to the manufacturing technologies involved as well as the material from which the nails are made.

Under harsher conditions, each nail class performs better than the one below, and the manufacturing costs, and thus the price of the nail, increase with each nail class.

	Nail Class	Nail featured			Concrete Class	Nail examples	Applications
		Ø	Hardness [HRC]	Tip			
Medium duty	Class I	> 4.0 mm	> 58	Helical, long conical		X-X X-AL-H ¹⁾	Best performance in tough concrete.
	Class II	4.0 mm	Up to 60	Ballastic or better		X-P X-U	High performance in tough concrete.
	Class III	3.5 to 3.7 mm	Up to 58	Mostly cut		X-C	High performance in medium concrete.
Light duty	Class IV	3.0 to 3.2 mm	Up to 58	Ballastic or better		X-P G2/G3/B3	Use in soft, medium and some tough concrete with shorter embedment, e.g. for track fastening to slab underside.
	Class V	2.6 to 3.0 mm	Up to 57	Mostly cut		X-C G2/G3/B3	Use in soft and medium concrete with shorter embedment, e.g. for track fastening.

¹⁾ X-AL-H nail is pre-mounted to X-CX ceiling fasteners

Nail class versus concrete type

Stick rate versus holding values of nail classes

Nail classes are clearly differentiated when faced with tough concrete. Depth of embedment, nail geometry, hardness and tip shape vary between nail classes.

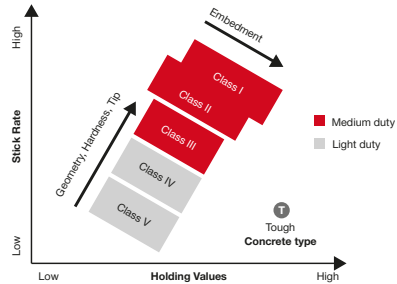

Stick rate of nail classes in different concrete types

Nail performance varies depending on the toughness of the concrete and the distribution of its aggregates. Nails of all classes perform similarly in soft concrete, but as the concrete gets tougher, the stick rate varies.

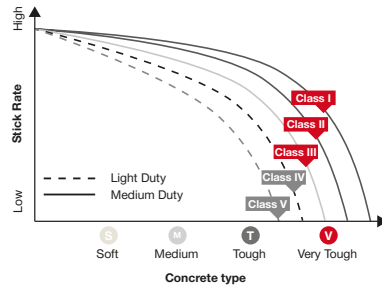

Select the right nail for concrete

Here are four simple steps to help guide you to the right nail

1. Understand the application
2. Be specific about important application requirements
3. Get to know the Hilti range of nails
4. Then choose the right nail based on application requirements



Following these four steps will help you:

- Maximize the stick rate.
- Achieve the required holding values.
- Select the most cost-efficient nail.
- Achieve optimum embedment depth based on selecting the appropriate cartridge and adjusting the power setting.



Improving the stick rate can be done in three different ways:

1. Use a shorter nail (if required embedment / load still can be reached with shorter nail)
2. Select a nail from a higher nail class (move from Nail Class III to II)
3. Use more energy (energy setting) / select different technology

Example:

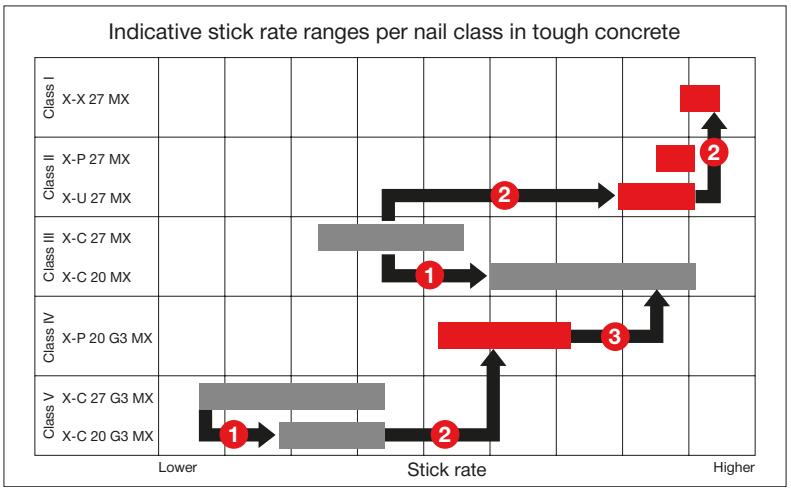

- no power and cartridge selection required for GX and BX systems.
- Important: other application relevant requirements, e.g. environmental conditions, corrosion resistance, etc., must be considered.

1.2 Selection based on environmental conditions

Corrosion may have a major influence on the suitability of a fastener for an application and therefore also on fastener selection. In order to provide a basis for judging the suitability of fasteners, it is useful to categorise applications in three classes:

- Non-safety relevant, temporary fastenings (e.g. fastenings of wooden kickers in concrete formwork)
- Non-safety relevant, permanent fastenings (e.g. metal track fastenings for drywall)
- Safety relevant, permanent fastenings (e.g. profiled metal sheet fastenings in roof and walls)

Non-safety-relevant , temporary and permanent fastenings: zinc-plated fasteners made of normal carbon steel can be used without restriction. Corrosion and related damages can, however, reduce the capacity of fasteners.

Safety-relevant, permanent fastenings: the restrictions described below apply:

- In any case where there is a restriction to use galvanized carbon steel fasteners if they are exposed to weather or if they are inside and subject to repeated wetting as from condensation. The galvanization (typically in a range from 5 to 20 microns of Zn) provides corrosion protection during transport and construction, during which exposure to weather can never be completely prevented. If the fastenings are exposed to repeated wetting or weather during their service life, the use of galvanized carbon steel fasteners is prohibited and stainless steel fasteners must be used. This safety measure must be observed without exception because the corrosion of galvanized steel fasteners leads not just to material loss but also to hydrogen embrittlement. Hydrogen embrittlement can easily result in fracture of the fastener at very low load.
- Referring to the above-mentioned example of profiled metal sheet fastening for roofs and walls, the use of galvanized steel fasteners is allowable only where wetting of the fastener is not to be expected. This applies in general to inside skins of two skin, insulated roofs and walls enclosing dry and closed rooms. This is the classic application area for X-ENP 19 galvanized fasteners.
- For special applications like swimming pools or tunnels, highly corrosion-resistant resistant stainless steel materials are recommended. See also Part 4, Chapter 4. Please consult Hilti in such cases

Contact corrosion is taken into consideration by observing common rules concerning acceptable material combinations. Parts made of less noble metals are subject to increased corrosion if they are in electrochemical contact with a larger part made of a more noble metal, provided of course that an electrolyte is present. Fasteners that are used in wet areas must be at least as noble or better nobler than the fastened part. The effect of contact corrosion is shown in the table below. This information is especially applicable to stainless steel fasteners, like X-CR, X-ST-GR and X-R, because these are suitable for safety-relevant, permanent application in outdoor areas or areas otherwise exposed to corrosion.

Fastened material	Power-actuated fastener	
	Zinc-plated carbon steel	Stainless steel
Construction steel (uncoated)	s	s
Galvanized steel sheet	s	s
Aluminum alloy	d	s
Stainless steel sheet	d	s

s = Negligible or no corrosion of fastener, d = Heavy corrosion of fastener

Accelerated corrosion of a fastener due to contact corrosion can take place only in the presence of an electrolyte (moisture from precipitation or condensation). Without this electrolyte – e.g. in dry inside rooms – zinc-plated fasteners can be used in connection with more noble metals.

2. Design concepts

The recommended working loads (N_{rec} and V_{rec}) are suitable for use in typical working load designs. If a partial safety factor design method is to be used, the N_{rec} and V_{rec} values are conservative when used as N_{Rd} and V_{Rd} . Exact values for N_{Rd} and V_{Rd} can be determined by using the safety factors where given and/or by reviewing test data. Design loads (characteristic strength, design resistance and working loads) for the X-HVB shear connector are listed as per design guideline.

Worldwide the designer may encounter two main fastening design concepts:

Working load concept

$$N_S \leq N_{rec} = \frac{N_{Rk}}{\gamma_{GLOB}}$$

where γ_{GLOB} is an overall factor of safety including allowance for:

- errors in estimation of load
- deviations in material and workmanship

and N_S is, in general a characteristic acting load.

$$N_S \equiv N_{Sk}$$

Partial factors of safety

$$N_{Sk} \cdot \gamma_F = N_{Sd} \leq \frac{N_{Rk}}{\gamma_M} = N_{Rd}$$

where:

γ_F is a partial factor of safety to allow for errors in estimation on the acting load.

γ_M is a partial factor of safety to allow for deviations in material and workmanship.

Structural analysis of the fastened part (e.g. roof deck panel or pipe hung from a number of fastenings) leads to calculation of the load acting on a single fastening, which is then compared to the recommended load (or design value of the resistance) for the fastener. In spite of this single point design concept, it is necessary to ensure that there is sufficient redundancy that the failure of a single fastening will not lead to collapse of the entire system. The old saying “one bolt is no bolt” applies also to Direct fastening.

3. Nomenclature/symbols

Following is a table of symbols and nomenclature used in the technical data.

Fastener test data and performance

N and V	Tensile and shear forces in a general sense.	
F	Combined force (resulting from N and V) in a general sense.	
N _s and V _s	Tensile and shear forces acting on a fastening in a design calculation.	
F _s	Combined force (resulting from N _s and V _s) in a design calculation.	
N _U and V _U	Ultimate tensile and shear forces that cause failure of the fastening; statistically, the reading for one specimen.	
N _{U,m} and V _{U,m}	Average ultimate tensile and shear forces that cause failure of the fastening, statistically, the average for a sample of several specimens.	
S	The standard deviation of the sample.	
N _{test,k} and V _{test,k}	Characteristic tensile and shear resistance of test data, statistically, the 5 % fractile.	
N _{Rk} and V _{Rk}	<p>Characteristic tensile and shear resistance of the fastening used for fastening design; statistically, the 5 % fractile. For example, the characteristic strength of a fastening whose ultimate strength can be described by a standard Gauss type distribution is calculated by:</p> $N_{Rk} = N_{U,m} - k \cdot S$ <p>where k is a function of the sample size n and the desired confidence interval.</p>	
N _{Rd} and V _{Rd}	<p>Tensile and shear design resistance of the fastening</p> $N_{Rd} = \frac{N_{Rk}}{\gamma_M} \text{ and } V_{Rd} = \frac{V_{Rk}}{\gamma_M}$ <p>where γ_M is a partial safety factor for the resistance of the fastening.</p>	
N _{rec} and V _{rec}	<p>Recommended tensile and shear force of the fastening</p> $N_{rec} = \frac{N_{Rk}}{\gamma_{GLOB}} \text{ and } V_{rec} = \frac{V_{Rk}}{\gamma_{GLOB}}$ <p>where γ_{GLOB} is an overall factor of safety.</p>	
M _{rec}	<p>Recommended working moment on the fastener shank</p> $M_{rec} = \frac{M_{Rk}}{\gamma_{GLOB}}$ <p>where M_{Rk} is the characteristic moment resistance of the fastener shank and γ_{GLOB} is an overall factor of safety. Unless otherwise stated on the product data sheets, the M_{rec} values in this manual include a safety factor of "2" for static loading.</p>	

Fastening details

h_{ET}	Penetration of the fastener point below the surface of the base material.
h_{NVS}	Nail head standoff above the surface fastened into (with nails, this is the surface of the fastened material, with threaded studs, the surface of the base material).
t_{II}	Thickness of the base material.
t_I	Thickness of the fastened material.
Σt_i	Total thickness of the fastened material (where more than one layer is fastened).

Characteristics of steel and other metals

f_y	Yield strength of steel.
f_u	Tensile strength of steel.

Characteristics of concrete and masonry

f_c	Compressive strength of cylinder (150 mm diameter, 300 mm height).
f_{cc}	Compressive strength of cube (150 mm edge length).
$f_{c,100} / f_{c,200}$	Compressive strength of 100 mm diameter cylinder / cube with 200 mm edge length.

Approvals, technical assessments and design guidelines are given on the product information sheets as abbreviations of the names of the issuing institutes or agencies.

Following is a list of abbreviations:



Abbreviation	Name of institute or agency / description	Country
FM	Factory Mutual (insurers' technical service)	USA
UL	Underwriters Laboratories (insurers' technical service)	USA
ICC	International Code Council	USA
SDI	Steel Deck Institute (technical trade association)	USA
CSTB	Centre Scientifique et Technique du Bâtiment (approval agency)	France
DIBt	Deutsche Institut für Bautechnik (approval agency)	Germany
SOCOTEC	SOCOTEC (insurers' technical service)	France
ÖNORM	Österreichische Norm / Austrian National Standard	Austria
SCI	Steel Construction Institute	Great Britain
ABS	American Bureau of Shipping (international classification society for ship and marine structures).	
LR	Lloyd's Register (international classification society for ship and marine structures).	
DNV GL	International classification society for the marine and energy industry.	



4. Tips for users

Tips for users (“Trouble Shooting”)

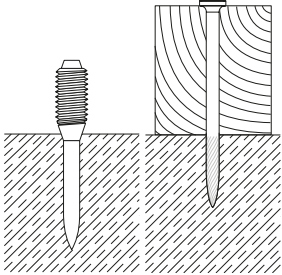
DX fastenings on concrete

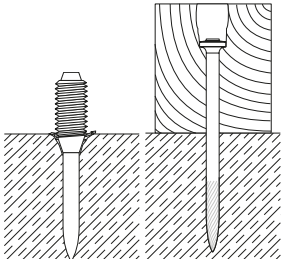
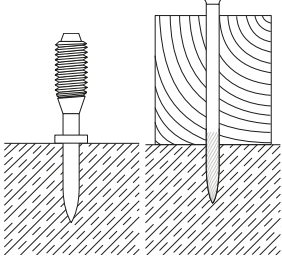
Observation	Cause	Possible remedial measures
<p>Fastener properly fixed</p> 	<ul style="list-style-type: none"> • Proper*) length of fastener • Proper cartridge • Proper power setting 	
<p>Fastener penetrates too deep</p> 	<ul style="list-style-type: none"> • Fastener too short*) • Too much driving power 	<ul style="list-style-type: none"> • Use longer fastener • Reduce power setting • Use lighter cartridge
<p>Fastener does not penetrate deep enough</p> 	<ul style="list-style-type: none"> • Fastener too long*) • Too little driving power 	<ul style="list-style-type: none"> • Use shorter fastener • Increase power setting • Use heavier cartridge

*) **Rule of thumb:** The higher the compressive strength of concrete, the shorter the fastener
Proper length (mm): $L_s = 22 + t_1$ (compare, “Fastening Technology Manual” Part Product section)

DX fastenings on concrete

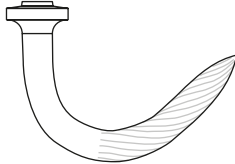
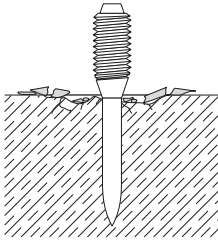
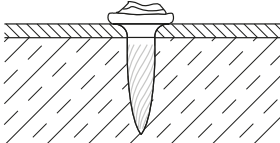
Observation	Cause	Possible remedial measures
<p>Nail is bending</p> 	<ul style="list-style-type: none"> • Hard and/or large aggregate in concrete • Rebar close to surface of concrete • Hard surface (steel) 	<ul style="list-style-type: none"> • Use shorter nail • Use DX-Kwik (predrill) • Use stepped shank nail X-U 15 • Change cartridge
<p>Base material is spalling</p> 	<ul style="list-style-type: none"> • High strength concrete • Hard and/or large aggregate in concrete • Old concrete 	<ul style="list-style-type: none"> • Stud application: Use spall stop X-460-F8SS / - F10SS • Nail application: Use shorter nail Use DX-Kwik (predrill) Use X-U 15 (for highstrength precast concrete)
<p>Damaged nail head</p> 	<ul style="list-style-type: none"> • Too much driving power • Wrong piston used • Damaged piston 	<ul style="list-style-type: none"> • Reduce power setting • Use lighter cartridge • Check nail-piston-combination • Change piston

Wrong pistons can cause all the above faults: match pistons to nails!

Fastener	Piston	Piston tip
X-U, X-C, X-P	Use piston X-460-P8	

DX fastenings on steel

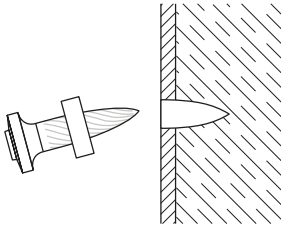
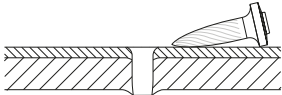
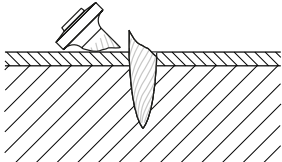
Observation	Cause	Possible remedial measures
<p>Nail does not penetrate surface</p> 	<ul style="list-style-type: none"> • Too little driving power • Application limit exceeded (very hard surface) • Unsuitable system 	<ul style="list-style-type: none"> • Try higher power setting or heavier cartridge • Short nail application: Try X-U 15 • Long nail application: Try X-U • Use co-acting principle/ fastener guide • Switch to heavy system like DX 76 PTR
<p>Nail does not hold in base material</p> 	<ul style="list-style-type: none"> • Excess driving energy in thin steel base material (3 to 4 mm steel) 	<ul style="list-style-type: none"> • Try different power setting or different cartridge • Try X-ENP2K or X-EDNK22 THQ 12 for fastening sheet metal
<p>Nail is breaking</p> 	<ul style="list-style-type: none"> • Too little driving power • Application limit exceeded (very hard surface) 	<ul style="list-style-type: none"> • Try higher power setting or heavier cartridge • Use shorter nail • Use X-ENP19 • Use stronger nail (X-...-H) • Use stepped shank nail: X-U 15

DX fastenings on steel

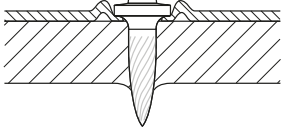
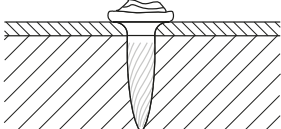
Observation	Cause	Possible remedial measures
<p>Nail head penetrates through material fastened (metal sheet)</p> 	<ul style="list-style-type: none"> • Too much driving power 	<ul style="list-style-type: none"> • Reduce power setting • Use lighter cartridge • Use nail with Top Hat • Use nail with washer e.g. X-U ...S12
<p>Damaged nail head</p> 	<ul style="list-style-type: none"> • Too much driving power • Wrong piston used • Worn-out piston 	<ul style="list-style-type: none"> • Reduce power setting • Use lighter cartridge • Check nail-piston-combination • Change piston

Wrong pistons can cause all the above faults: match pistons to nails!

Fastener	Piston	Piston tip
X-U, X-P, X-S	Use piston X-460-P8	





5. Nail and stud designation

Nail designation

X-C		32	P8 S23 T	
Application:			Washer type X (in mm):	
X-ENP	Siding and Decking Nails		P	Plastic washer e.g. P8 = plastic washer Ø 8
X-ENP2K			S	Steel washer e.g. S36 = steel washer Ø 36
X-HSN	Diaphragm Decking Nails		D	Two washers
NPH	Siding and Decking Nails to Concrete		L	Two domed washers
X-U	Universal Nails		TH	Top Hat
X-P	High Performance Nail for Fastening to Concrete		THQ	Top Hat and high shear washer
X-C	Nails for Concrete and Sand lime-Masonry		MX	Collated for DX tool/ collated fasteners for GX/BX
X-S	Drywall and electrical fasteners to Steel		MXR	Collated for DX 860-ENP
X-EGN	Gas Nails for GX 120		T	For tunneling applications
X-GHP			MXR	Collated for DX 860-ENP
X-GN			T	For tunneling applications
DS	Heavy Duty Nails for Concrete and Steel		B_	For battery tools, e.g. B3
EDS	Heavy Duty Nails for Fastening Steel to Steel		G_	For gas tools, e.g. G3
X-R	Stainless Steel Nail for Fastening to Steel		Dimensions:	
X-CR	Stainless Steel Nails for Concrete, Sand lime Masonry and Steel. And Steel only.		Nail shank length in mm (For details, please refer to product data)	
X-CT	Nails for Forming or other Temporary uses			
DNH	DX-Kwik Nails for Concrete			
X-DKH	(pre-drilled)			

Examples:

X-U 52 P8

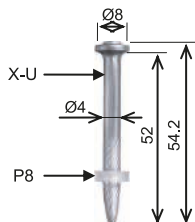

X-U 52 MX

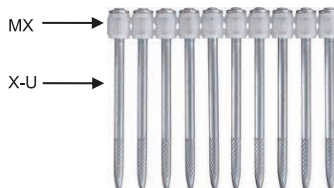

Threaded stud designation

X-M6H		10-37	FP8			
Application:			Washer type and X (in mm):			
X-M6H	DX-Kwik Threaded Studs for Concrete (pre-drilled)		P	Plastic washer e.g. P8 = plastic washer X 8		
X-M8H			S	Steel washer e.g. S8 = steel washer X 8		
X-M6		Threaded Studs for Steel		D	Two washers	
X-W6				F	Plastic guidance sleeve	
X-F7				SN12-R	Stainless steel washer for sealing purposes	
X-M8				B_	For battery tools, e.g. B3	
M10				G_	For gas tools, e.g. G3	
W10						
X-EM6H			Stainless Steel Threaded Studs			
X-EW6H						
X-EF7H						
X-EM8H						
X-EM10H						
X-EW10H						
X-BT	Stainless Steel Threaded Studs for Concrete and Steel					
X-CRM						
X-ST						
			Dimensions:			
			Thread Length and Shank Length in mm			

where M, W, F refer to the thread type:

M	Metric
W	Whitworth
F	French

Examples:

X-BT W10-24-6 SN12-R

X-BT M10-24-6 SN12-R

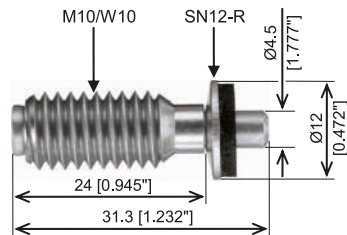

X-BT, X-ST, S-BT Threaded studs designation

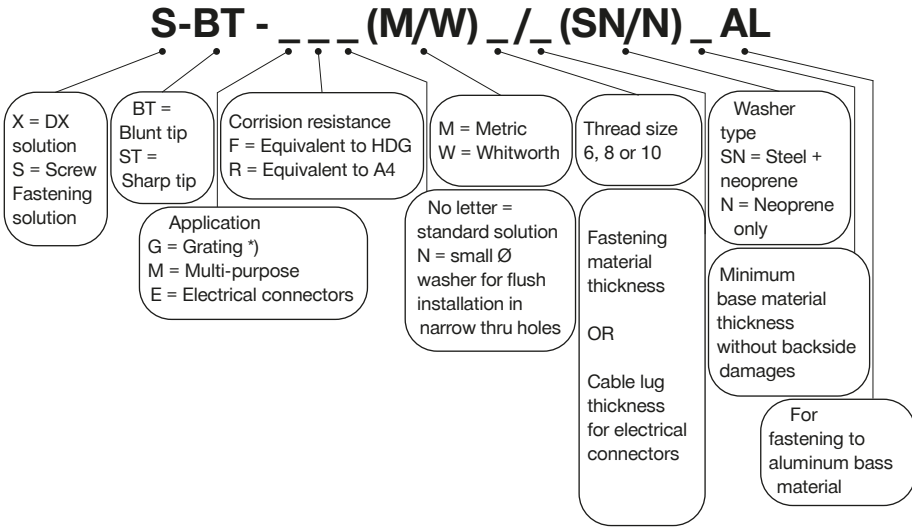

*) X-ST-GR stainless steel threaded studs may also be used for multi-purpose applications.

Examples

- S-BT-MR M10/15 SN 6 AL
- S-BT-GR M8/7 SN 6
- X-BT-MF M10/10 SN 4
- X-BT-ER M8/6 SN 4

Wood nail designation

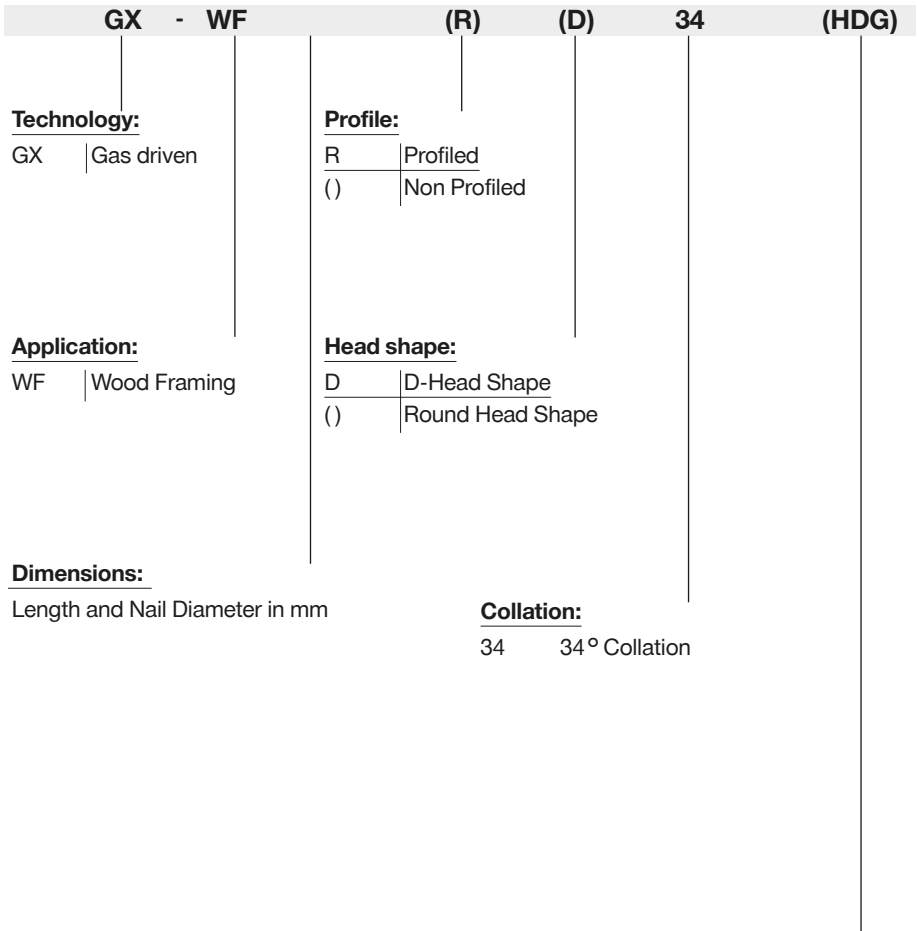

Designation of corrosion protection on the box/label

Suffix	Type of protection	Service Class (EN 1995-1-1)
“Bright”	no coating	1
“Galv”	12 µm zinc	1, 2
“HDG”	55 µm hot dip galvanized	1, 2, 3
“Stainless”	A2 or A4	1, 2, 3



Part 3:

Accessories and consumables compatibility



DX 2 Semi-automatic powder-actuated tool for fastening single nails



Fastener:

- _____ X-X
- _____ X-P
- _____ X-U
- _____ X-C
- _____ X-CR
- _____ X-CT
- _____ X-M6/W6/F7/M8
- _____ X-FS
- _____ X-SW
- _____ X-FB
- _____ X-DNH
- _____ X-DKH
- _____ X-M6H, X-M8H
- _____ X-HS
- _____ X-CC
- _____ X-CRM

Cartridges:

6.8/11M –
 _____ red, yellow, green

DX 351 Powder-actuated tool for interior finishing applications



Fastener:

X-P_MX
 X-U_MX
 X-C_MX
 X-S 13 MX

Piston:

X-P 8S-351

Cartridges:

6.8/11M –
 red, yellow, green, white

DX 351-F8 Powder-actuated tool for interior finishing, mechanical and electrical applications



Fastener:

X-P_P8
 X-C_P8/TH/THP
 X-U15 P8TH
 X-CC-U_P8
 X-HS_-U_P8S15

Cartridges:

6.8/11M –
 red, yellow, green, white

Fastener guide:

X-FG 8L-351
 narrow access fastener
 guide

Piston:

X-P 8L-351



X-FG 8ME-351
 standard fastener guide

Piston:

X-P 8S-351



DX 351-BT Powder-actuated tool for fastening X-BT threaded studs

Fastener:

X-BT M10-24-6 SN12-R
 X-BT M10-24-6-R
 X-BT W10-24-6 SN12-R
 X-BT W10-24-6-R
 X-BT M6-24-6 SN12-R
 X-BT W6-24-6 SN12-R
 X-BT-ER M10/3 SN4
 X-BT-ER W10/3 SN4
 X-BT-ER M8/7 SN4
 X-BT-ER M6/7 SN4
 X-BT-ER W6/7 SN4
 X-BT-MF M/W 10

Piston:

X-351 BT P 1024

Fastener guide:

BT FG M1024 (M10)
 BT FG W1024 (W10)
 Fastener Guide dimensions
 $b \times d \times L = 17.5 \times 22 \times 29.5 \text{ mm}$

Cartridges:

6.8/11M -
 high precision - brown

DX 351-BTG Powder-actuated tool for fastening gratings

Fastener:

X-BT M8-15-6 SN12-R
 X-BT M8-15-6-R

Piston:

X-351 BT P G

Fastener guide:

X-352 BT FG G (M8)
 Fastener Guide dimensions
 $b \times d \times L = 17.5 \times 22 \times 56 \text{ mm}$

Cartridges:

6.8/11M -
 high precision - brown

DX 351-CT Fully automatic powder-actuated tool for fastening ceiling fasteners to concrete or steel

Fastener:

X-CW
 X-CC
 X-HS
 X-U
 X-C

Piston:

X-P8-351 CT

Cartridges:

6.8/11M -
 red, yellow, green

Fastener guide:

X-351-F8CT

Powder-actuated tool

DX 450 Powder-actuated tool – standard



Fastener guide:

45/F1

Fastener:

X-CR 14 D12

X-CR 16 S12

X-CR 18 S12

X-CR 21 S12

X-CR 24 S12

Piston:

45/NK

Baseplate:

45/S1

Cartridge:

6.8/11 M

yellow, red



- Tool is not offered by Hilti anymore.

DX 450-FA Powder-actuated tool – facade



Fastener guide:

45/F5

Fastener:

X-R_P8

X-CR 14 P8

X-CR 16 P8

X-CR 18 P8

X-CR 21 P8

Piston:

45/DNI-B

Baseplate:

45/S5

Cartridge:

6.8/11 M

yellow, red

DX 460-MX Powder-actuated tool for fastening collated nails



Fastener:

X-P_MX
 X-U_MX
 X-C_MX
 X-CT_MX
 X-ET_MX
 X-ECT_MX
 X-EKS_MX,
 X-FB_MX
 X-FS_MX,
 X-SW_MX
 X-HS_MX
 X-CC_MX
 X-HS-W_MX
 X-EKB_MX

Piston:

X-6-5-P8
 X-6-5-P8W
 for fastening wood

Cartridges:

6.8/11M –
 black, red, yellow, green

DX 460-F8 Powder-actuated tool for fastening single nails



Fastener:

X-P_P8
 X-U_P8 / P8 TH
 X-C_P8
 X-CR_P8/ P8S12
 X-CR M8
 X-CT_DP8
 X-FS, X-SW
 X-FB
 X-EM6H-_-FP8
 X-EW6H-_-FP8
 X-EF7H-_-FP8
 X-M6/W6-_-FP8
 X-EM8H-_-P8
 X-M8-_-P8
 X-HS, X-CC
 X-HS-W_P8

Piston:

X-6-5-P8
 X-6-5-P8W
 for fastening wood

Cartridges:

6.8/11M –
 black, red, yellow, green

DX-Kwik method:

pre-drilling into concrete

Fastener:

X-M6H-_-37 FP8
 X-M8H-_37 P8
 X-CRM8-_42

Piston:

X-6-5-PKwik

Fastener:

X-DNH 37 P8S15
 X-DKH 48 P8S15

Piston:

X-6-5-P8

Fastener guide:

X-5-460-F8N15
 Narrow access fastener
 guide
 (Ø 15.2 mm×53.2 mm)



Fastener:

X-P_P8
 X-C
 X-CR_P8
 X-CRM_P8
 X-ST-GR M8_P8

Piston:

X-6-5-P8

Fastener guide:

X-5-460-F8N10
 Narrow access fastener
 guide
 (b×d×L 10.4×25.9×50 mm)



Fastener:

X-P_P8
 X-U_P8
 X-C
 X-CR_P8
 X-CRM_P8

Piston:

X-6-5-P8

Fastener guide:

X-5-460-F8GR
 Grating fastener guide



Fastener:

X-GR
 X-PGR-RU
 X-ST-_M8_P8
 X-EM 8H

Piston:

X-6-5-PGR

Fastener guide:

X-5-460-F8S12
 S12 fastener guide



Fastener:

X-U_S12

Piston:

X-6-5-P8

Fastener guide:

X-5-460-F8SS

8 mm stop spall fastener
guide

Fastener:

X-M6-_-_FP8

X-W6-_-_FP8

X-F7-_-_FP8

X-M8-_-_P8

Piston:

X-6-5-P8

Fastener guide:

X-5-460-F10

Fastener:

M10 (possible)

Piston:

X-6-5-P10

Fastener guide:

X-5-460-F10SS

10 mm stop spall fastener
guide

Fastener:

M10 (possible)

Piston:

X-6-5-P10

Fastener guide:

X-5-460-FIE-XL

Fastener:

X-IE

Insulation fastener

Piston:

X-6-5-PIE-XL

DX 460-SM Powder-actuated tool for fastening metal decks**Fastener:**

X-EDNK22-THQ12M

X-EDN19-THQ12M

X-HSN 24**Piston:**

X-5-460-PSM**Cartridges:**

6.8/11M –

black, red, yellow

DX 5 MX Digitally enabled powder-actuated tool for fastening collated nails



Fastener:

X-X_MX
 X-P_MX
 X-U_MX
 X-C_MX
 X-CT_MX
 X-ET_MX
 X-ECT_MX
 X-EKS_MX
 X-FB_MX
 X-FS_MX
 X-SW_MX
 X-HS_MX
 X-CC_MX
 X-HS-W_MX
 X-EKB_MX

Piston:

X-6-5-P8
 X-6-5-P8W
 for fastening wood

Cartridges:

6.8/11M -
 black, red, yellow, green

DX 5 F8 Digitally enabled powder-actuated tool for fastening single nails



Fastener:

X-X_P8
 X-U_P8 / P8 TH
 X-C_P8
 X-CR_P8/ P8S12
 X-CR M8
 X-R_P8
 X-ST-GR M8_P8
 X-CT_DP8
 X-FS, X-SW

X-FB
 X-EM6H/EW6H-_-FP8
 X-EF7H/-_-FP8
 X-M6/W6-_-FP8
 X-EM8H-_-P8
 X-M8-_-P8
 X-HS, X-CC
 X-HS-W_P8

Piston:

X-6-5-P8
 X-6-5-P8W
 for fastening wood

Cartridges:

6.8/11M -
 black, red, yellow, green

DX-Kwik method:

pre-drilling into concrete

Fastener:

X-M6H-_-37 FP8

X-M8H-_37 P8

X-CRM8-_42

Piston:

X-6-5-Pkwik

Fastener:

X-DNH 37 P8S15

X-DKH 48 P8S15

Piston:

X-6-5-P8

Fastener guide:

X-5-460-F8N15

Narrow access fastener
guide

(Ø 15.2 mm×53.2 mm)



Fastener:

X-P_P8

X-C

X-CR_P8

X-CRM_P8

X-ST-GR M8_P8

Piston:

X-6-5-P8

Fastener guide:

X-5-460-F8N10

Narrow access fastener
guide

(b×d×L 10.4×25.9×50 mm)



Fastener:

X-P_P8

X-U_P8

X-C

X-CR_P8

X-CRM_P8

Piston:

X-6-5-P8

Fastener guide:

X-5-460-F8GR

Grating fastener guide



Fastener:

X-GR

X-PGR-RU

X-EM 8H

Piston:

X-6-5-PGR

Fastener guide:

X-5-460-F8S12

S12 fastener guide



Fastener:

X-U_S12

Piston:

X-6-5-P8

Fastener guide:

X-5-460-F8SS

8 mm stop spall fastener
guide

Fastener:

X-M6-_-_FP8

X-W6-_-_FP8

X-F7-_-_FP8

X-M8-_-_P8

Piston:

X-6-5-P8

Fastener guide:

X-5-460-F10

Fastener:

M10 (possible)

Piston:

X-6-5-P10

Fastener guide:

X-5-460-F10

10 mm stop spall fastener
guide

Fastener:

M10 (possible)

Piston:

X-6-5-P10

Fastener guide:

X-5-460-FIE-XL

Fastener:

X-IE

Insulation fastener

Piston:

X-6-5-PIE-XL

DX 5 IE Powder-actuated tool for fastening insulation



Fastener:
 X-IE
 insulation fasteners

Piston:
 X-6-5-PIE-XL

Cartridges:
 6.8/11M –
 red, yellow, green

DX 5 GR Powder-actuated tool for fastening gratings



Fastener:
 X-GR
 X-PGR-RU
 X-EM 8H

Piston:
 X-6-5-PGR

Cartridges:
 6.8/11M –
 black, red

DX 5 SM Powder-actuated tool for fastening metal decks



Fastener:
 X-EDNK22-THQ12M
 X-EDN19-THQ12M
 X-HSN 24

Piston:
 X-5-460-PSM

Cartridges:
 6.8/11M –
 black, red, yellow

DX 5 F10 Powder-actuated tool for fastening threaded studs



Fastener:
 DS_P10
 X-EM8H-15-12 FP10
 X-EM10H-24-12 P10

Piston:
 X-6-5-P10

Cartridges:
 6.8/11M –
 black, red, yellow, green

DX6 MX Digitally enabled powder-actuated tool for fastening collated nails



Fastener guide:

X-6-MX72



Fastener:

X-X_MX

X-P_MX

X-U_MX

X-C_MX

X-CT_MX

X-FS_MX

X-SW_MX

X-ET_MX

X-ECT_MX

X-EKS_MX

X-FB_MX

X-HS_MX

X-HS-W_MX

X-ECC_MX

X-ECH_MX

X-EKB_MX

Piston:

X-6-5-P8

X-6-5-P8W

for wood fastening

Cartridge:

6.8/11 M 10 for DX 6

titanium, black

DX6 F8 Digitally enabled powder-actuated tool for fastening single nails



Standard fastener guide

Fastener guide:

X-6-F8



Fastener:

X-X_P8

X-P_P8

X-U_P8

X-U_P8 TH

X-C_P8

X-CR_P8

X-CR_P8S12

X-CR M8

X-R_P8

X-ST-GR M8_P8

X-CT_DP8

X-FS

X-DFS

X-SW

X-FB

X-EM6H-_FP8

X-EW6H-_FP8

X-EF7H-_FP8

X-M6-_FP8

X-W6-_FP8

X-F7-_FP8

X-EM8H-_P8

X-M8-_P8

X-HS

X-CC

X-HS-W_P8

Piston:

X-6-5-P8

X-6-5-P8W

for wood fastening

X-6-5-P8AL

Cartridge:

6.8/11 M 10 for DX 6

titanium, black

DX-Kwik fastener guide (DX-Kwik method/pre-drilled concrete)

Fastener guide:

X-6-F8



Fastener:

X-M6H- _37 FP8

X-M8H- _37 P8

X-CRM8- _42

Piston:

X-6-5-PKwik

Cartridge:

6.8/11 M10 for DX 6
titanium, black

Fastener:

X-DNH 37 P8S15

X-DKH 48 P8S15

Piston:

X-6-5-P8

Cartridge:

6.8/11 M10 for DX 6
titanium, black

Narrow access fastener guide (Ø: 15.2 mm, h: 53.2 mm)

Fastener guide:

X-6-F8N15



Fastener:

X-P_P8

X-U_P8

X-C_P8

X-CR_P8

X-CRM_P8

X-ST-GR M8_P8

Piston:

X-6-5-P8

Cartridge:

6.8/11 M10 for DX 6
titanium, black

Narrow access fastener guide (w × t × h: 10.4 × 25.9 × 50 mm)

Fastener guide:

X-6-F8N10



Fastener:

X-P_P8

X-U_P8

X-C_P8

X-CR_P8

X-CRM_P8

Piston:

X-6-5-P8

Cartridge:

6.8/11 M10 for DX 6
titanium, black

Grating fastener guide

Fastener guide:

X-6-FGR

Fastener:

 X-GR
 X-PGR-RU
 X-EM 8H

Piston:

X-6-5-PGR

Cartridge:

 6.8/11 M10 for DX 6
 titanium, black

M10 fastener guide

Fastener guide:

X-6-F10

Fastener:

 DS_P10
 EDS 19 P10, EDS 22 P10
 X-EM8H-15-12 FP10
 X-EM10H-24-12 P10

Piston:

X-6-5-P10

Cartridge:

 6.8/11 M10 for DX 6
 titanium, black

Insulation fastener guide (up to 140 mm insulation thickness)

Fastener guide:

X-6-FIE-L

Fastener:

 X-IE
 XI-FV

Piston:

X-6-5-PIE-L

Cartridge:

 6.8/11 M10 for DX 6
 titanium

Insulation fastener guide (up to 200 mm insulation thickness)

Fastener guide:

X-6-FIE-XL

Fastener:

 X-IE
 XI-FV

Piston:

X-6-5-PIE-XL

Cartridge:

 6.8/11 M10 for DX 6
 titanium

DX6 IE Digitally enabled powder-actuated tool for fastening insulation



Fastener guide:

X-6-FIE-XL

Fastener:

X-IE

XI-FV

Piston:

X-6-5-PIE-XL



Cartridge:

6.8/11 M10 for DX 6
titanium

DX6 GR Digitally enabled powder-actuated tool for fastening grating



Fastener guide:

X-6-FGR

Fastener:

X-GR

X-PGR-RU

X-EM 8H

Piston:

X-6-5-PGR



Cartridge:

6.8/11 M10 for DX 6
titanium, black

DX6 F10 Digitally enabled powder-actuated tool



Fastener guide:

X-6-F10

Fastener:

DS_P10

EDS 19 P10, EDS 22 P10

X-EM8H-15-12 FP10

X-EM10H-24-12 P10

Piston:

X-6-5-P10



Cartridge:

6.8/11 M10 for DX 6
titanium, black

DX76 PTR Powder-actuated tool for fastening metal decks with collated nails



Fastener:
X-ENP-19 L15 MX

Piston:
X-76-P-ENP-PTR

Piston brake:
X-76-PB-PTR

Cartridges:
6.8/18M - black, red, blue

Fastener:
X-ENP2K-20 L15 MX

Piston:
X-76-P-ENP2K-PTR

Piston brake:
X-76-PB-PTR

Cartridges:
6.8/18M - red, blue, green

DX76 PTR Powder-actuated tool for fastening metal decks with single nails



Fastener:
X-ENP-19 L15

Piston:
X-76-P-ENP-PTR

Fastener guide:
X-76-F-15-PTR

Piston brake:
X-76-PB-PTR



Cartridges:
6.8/18M - black, red, blue

Fastener:
X-ENP2K-20 L15

Piston:
X-76-P-ENP2K-PTR

Fastener guide:
X-76-F-15-PTR

Piston brake:
X-76-PB-PTR



Cartridges:
6.8/18M - red, blue, green

DX 76 PTR Powder-actuated tool for fastening metal decks on concrete – DX-Kwik



Fastener:

NPH2-42 L15

Piston:

X-76-P-Kwik-PTR

Fastener guide:

X-76-F-Kwik-PTR

Piston brake:

X-76-PB-PTR



Cartridges:

6.8/18M – blue, yellow

DX 76 PTR Powder-actuated tool for fastening HVB shear connectors



Fastener:

X-ENP-21 HVB

Piston:

X-76-P-HVB-PTR

Connector:

X-HVB shear connectors

Piston stop:

X-76-PS

Fastener guide:

X-76-F-HVB-PTR

Cartridges:

6.8/18M – black, red



DX 76 PTR Powder-actuated tool for fastening gratings and checker plates



Grating fastener:

X-CRM8-15-12 P8

X-EM8H_P8

X-ST-GR M8_P8

Chequer plate fastener

X-CRM8-15-12 P8

X-CRM8-9-12 P8

X-ST-GR M8_P8

Fastener guide:

X-76-F-8-GR-PTR

(Δ 19 mm×58 mm)

Piston:

X-76-P-8-GR-PTR

Piston brake:

X-76-PB-PTR

Cartridges:

6.8/18M –

blue, yellow

For X-GR and X-GRRU:

red, blue, yellow



DX 76 PTR Powder-actuated tool for fastening heavy duty applications



Fastener:

EDS 19 P10, EDS 22 P10

X-EM10H-24-12 P10

X-EM8H-15-12 FP10

X-CR M8-15-12 FP10

X-CR M8-9-12 FP10

DS27 – 37 P10

Fastener guide:

X-76-F-10-PTR

(Δ 19 mm×58 mm)

Piston:

X-76-P-10-PTR

Piston brake:

X-76-PB-PTR

Cartridges:

6.8/18M –

black, red, blue



DX 76 MX Powder-actuated tool for fastening metal decks with collated nails



Fastener:
X-ENP-19 L15 MX

Piston:
X-76-P-ENP

Cartridges:
6.8/18M – black, red, blue

Fastener:
X-ENP2K-20 L15 MX

Piston:
X-76-P-ENP2K

Cartridges:
6.8/18M –
red, blue, yellow, green

DX 76 Powder-actuated tool for fastening metal decks with single nails



Fastener:
X-ENP-19 L15

Piston:
X-76-P-ENP

Fastener guide:
X-76-F-15

Cartridges:
6.8/18M – black, red, blue



Fastener:
X-ENP2K-20 L15

Piston:
X-76-P-ENP2K

Fastener guide:
X-76-F-15

Cartridges:
6.8/18M –
red, blue, yellow, green



DX 76 Powder-actuated tool for fastening metal decks on concrete – DX-Kwik



Fastener:

NPH2-42 L15

Piston:

X-76-P-Kwik

Fastener guide:

X-76-F-Kwik

Cartridges:

6.8/18M – blue, yellow



DX 76 Powder-actuated tool for fastening HVB shear connectors



Fastener:

X-ENP-21 HVB

Piston:

X-76-P-HVB

Connector:

X-HVB shear connectors

Piston Stop:

X-76-PS

Fastener guide:

X-76-F-HVB

Cartridges:

6.8/18M – black, red



DX 76 Powder-actuated tool for fastening gratings and checker plates



Grating fastener:

X-CRM8-15-12 FP10

X-EM8-15-12 FP10

Checker plate fastener

X-CRM8-15-12 FP10

X-CRM8-9-12 FP10

Fastener guide:

X-76-F-10

Piston:

X-76-P-GR

Cartridges:

6.8/18M –
black, red, blue, yellow,
green



DX 76 Powder-actuated tool for fastening heavy duty applications



Fastener: (for nail)

EDS 19 P10, EDS 22 P10

Fastener: (for stud)

X-EM10-24-14 P10

Fastener guide:

X-76-F-10

for nails and studs

Piston: (for nail)

X-76-P-10

Piston: (for stud)

X-76-P-GR

Cartridges:

6.8/18M –
black, red, blue, yellow,
green



DX 860-ENP Powder-actuated tool for fastening metal decks



Fastener:
X-ENP-19 L15 MXR

Piston:
X-76-P-ENP

Cartridges:
6.8/18M40 –
black, red, blue

DX 860-HSN Powder-actuated tool for fastening metal decks



Fastener:
X-EDNK22-THQ12M
X-EDN19-THQ12M
X-HSN 24

Piston:
X-860-P10

Cartridges:
6.8/11M40 –
black, red, yellow

DX 9-ENP Digitally enabled powder-actuated tool for fastening metal decks



Fastener:
X-ENP-19 L15 MXR

Piston:
Piston X-9-ENP kit

Nail Magazine:
MX 9 - ENP packed

Cartridges:
6.8/18M40 –
black, red, blue

DX 9-HSN Digitally enabled powder-actuated tool for fastening metal decks



Fastener:
X-EDNK22-THQ12M
X-EDN19-THQ12M
X-HSN 24





Piston:
X-9-HSN kit

Nail Magazine:
MX 9 - HSN packed

Cartridges:
6.8/11M40 –
black, red, yellow

Cartridges – Propellants for powder-actuated tools

The table below provides an overview of the main Hilti cartridges and their characteristics. For more information about cartridges and power levels, please refer to section **2.5.1 Cartridges (power loads, boosters)**.

Cartridge	Color code*	Energy scale*	Fastening tools			
			DX 2, DX 36	DX 450, DX 460, DX 462, DX 5	DX 351	DX 860-HSN ¹ DX 9-HSN ¹
6.8/11M10 and 6.8/11M40 ¹ (.27 caliber short) 	High precision brown white [brown] green yellow red black [purple]	2 [2] 2 [2] 3 [3] 4 [4] 6 [5] 7 [6]			■ ■ ■ ■ ■ ■	
6.8/11M10 for DX6 (.27 caliber short) 	titanium** black	6 [5] 7 [6]	DX6 DX6			
6.8/18M10 (.27 caliber long) 	green yellow blue red black [purple]	3 4 5 [4.5] 6 [5] 7 [6]	DX 76 / DX 76 PTR DX 76 / DX 76 PTR DX 76 / DX 76 PTR DX 76 / DX 76 PTR DX 76 / DX 76 PTR			
6.8/18M40 (.27 caliber long) 	blue red black [purple]	5 [4.5] 6 [5] 7 [6]	DX 860-ENP, DX 9-ENP DX 860-ENP, DX 9-ENP DX 860-ENP, DX 9-ENP			
6.8/18 (.27 caliber long) 	green yellow red black [purple]	3 4 5 7 [6]	DX 600N DX 600N DX 600N DX 600N			

■ = compatible

* Color code and energy scale according to EN 16264, in brackets according to PATMI Training Manual.

** Hilti color code for DX6 cartridge stripe.



- All collated Hilti cartridges are available as Clean-Tec, environmentally-friendly heavy metal free cartridges except for 6.8/18 (.27 calibre long) for DX 600N tool.

Gas-actuated tools

GX 90 WF Gas-actuated tool for wood framing



Fastener:

- GX-WF_
- smooth bright MX 34
- GX-WF_
- profiled bright MX 34
- GX-WF_
- smooth galvanized MX 34
- GX-WF_
- profiled galvanized MX 34
- GX-WF_
- smooth HDG MX 34
- GX-WF_
- profiled HDG MX 34
- GX-WF_
- profiled A2 stainless D-head

- GX-WF_
- profiled A2 stainless full round head
- GX-WF_
- profiled A4 stainless D-head
- GX-WF_
- profiled A4 stainless full round head

Energy:

GC 32



GX 120 Gas-actuated tool for interior finishing applications



Fastener:

- X-EGN 14 MX
- X-GHP 16 MX
- X-GHP 17 MX
- X-GHP 20 MX
- X-GHP 24 MX
- X-GN 20 MX
- X-GN 27 MX
- X-GN 32 MX
- X-GN 39 MX

Energy:

- GC20. GC 21 and GC 22



GX 120-ME Gas-actuated tool for mechanical and electrical applications



Fastener:

- X-EGN 14 MX
- X-GHP 16 MX
- X-GHP 17 MX
- X-GHP 20 MX
- X-GHP 24 MX
- X-GN 20 MX
- X-GN 27 MX
- X-GN 32 MX
- X-GN 39 MX
- X-EHS MX
- X-ECC MX
- X-HS-W MX
- X-EKB MX
- X-FB MX
- X-DFB MX
- X-ECT MX
- X-ET MX
- X-EKS MX
- X-EMTSC
- X-G M6/W6
- X-UCT MX
- X-SW 30, X-SW 60

Energy:

- GC20. GC 21 and GC 22



GX 3 Gas-actuated tool for interior finishing and building construction applications



Fastener:

- X-S 14 G3 MX
- X-P 17 G3 MX
- X-P 20 G3 MX
- X-P 24 G3 MX
- X-C 20 G3 MX
- X-C 27 G3 MX
- X-C 32 G3 MX
- X-C 39 G3 MX
- X-M6-7-14 G3 P7
- X-M6-7-24 G3 P7
- X-W6-12-20 G3 P7
- X-W6-12-14 G3 P7

Energy:

GC42 for international



GC41 for use in
North America

GC40 for use in Japan

GX 3-ME Gas-actuated tool for mechanical and electrical applications



Fastener:

- X-S 14 G3 MX
- X-P 17 G3 MX
- X-P 20 G3 MX
- X-P 24 G3 MX
- X-C 20 G3 MX
- X-C 27 G3 MX
- X-C 32 G3 MX
- X-C 39 G3 MX
- X-M6-7-14 G3 P7
- X-M6-7-24 G3 P7
- X-W6-12-20 G3 P7
- X-W6-12-14 G3 P7

Energy:

GC42 for international



GC41 for use in
North America

GC40 for use in Japan

GX 2 Gas-actuated tool for interior finishing and building construction applications

Fastener:

X-P 14 G2 MX
X-P 17 G2 MX
X-P 20 G2 MX
X-C 20 G2 MX
X-C 27 G2 MX
X-C 32 G2 MX
X-C 39 G2 MX

Energy:

GC52



Gas cans

The table below provides an overview of the main Hilti gas cans and their characteristics.

Model	Number of fastenings per can	Temperature range		Fuel gauge	Tool to be used with
GC 21	750	-5°C - +50°C		Yes	GX 120
GC 22	750	-10°C - +50°C		Yes	GX 120
GC 32	1000	-10°C - +50°C		No	GX 90 - WF
GC 42	1200	-10°C - +50°C		Yes	GX 3
GC 52	1100	-10°C - +50°C		Yes	GX 2

Note: The models sold in North America and Japan have slightly different characteristics.

Battery-actuated tools

BX 3-BT Battery-actuated tool for multi-purpose and electrical connection applications



Fastener:

- X-BT-MR M6/10 SN 8
- X-BT-MR W6/10 SN 8
- X-BT-MR M8/14 N 8
- X-BT-MR M10/15 SN 8
- X-BT-MR W10/15 SN 8
- X-BT-ER M6/3 SN 8
- X-BT-ER W6/3 SN 8
- X-BT-ER M8/7 SN 8
- X-BT-ER M10/7 SN 8
- X-BT-ER W10/7 SN 8
- X-BT M10-24-6 SN12-R
- X-BT M10-24-6-R
- X-BT W10-24-6 SN12-R
- X-BT W10-24-6-R
- X-BT-ER M10/3 SN4
- X-BT-ER W10/3 SN4
- X-BT-ER M8/7 SN4

Energy:

Battery

Fastener Guide:

- X-FG B3-BT M (M6/M8/M10)
- X-FG B3-BT W (W6/W10)

BX 3-BTG Battery-actuated tool for fastening gratings



Fastener:

- X-BT-GR M8/7 SN 8
- X-BT M8-15-6 SN12-R

Energy:

Battery

Fastener Guide:

- X-FG B3-BTG (M8 short)

BX 3-IF Battery-actuated tool for interior finishing and building construction applications



Fastener:

- X-S 14 B3 MX
- X-P 17 B3 MX
- X-P 20 B3 MX
- X-P 24 B3 MX
- X-C 20 B3 MX
- X-C 24 B3 MX
- X-C 30 B3 P7
- X-C 36 B3 P7
- X-M6-7-14 B3 P7
- X-M6-7-24 B3 P7
- X-W6-12-20 B3 P7
- X-W6-12-14 B3 P7

Energy:

Battery

BX 3-ME Battery-actuated tool for mechanical and electrical applications



Fastener:

- X-S 14 B3 MX
- X-P 17 B3 MX
- X-P 20 B3 MX
- X-P 24 B3 MX
- X-P 30 B3 P7
- X-P 36 B3 P7
- X-C 20 B3 MX
- X-C 24 B3 MX
- X-M6-7-24 B3 P7
- X-M6-7-14 B3 P7
- X-W6-12-20 B3 P7
- X-W6-12-14 B3 P7
- X-EHS MX
- X-ECC MC
- X-HS-W MX
- X-EKB MX

- X-FB MX
- X-DFB MX
- X-ECT MX
- X-ET MX
- X-EKS MX
- X-EMTSC MC
- X-ECH MX
- X-UCT MX
- X-DHS MX
- X-ECH FE MX
- X-EKB FE MX
- X-SW MX

Energy:

Battery

BX 3 (02) Battery-actuated tool for interior finishing applications**Fastener:**X-S 14 B3 MXX-P 17 B3 MXX-P 20 B3 MXX-P 24 B3 MXX-C 20 B3 MXX-C 24 B3 MXX-C 30 B3 MX**Energy:**Battery**BX 3-L (02)** Battery-actuated tool for interior finishing applications**Fastener:**X-S 14 B3 MXX-P 17 B3 MXX-P 20 B3 MXX-P 24 B3 MXX-C 20 B3 MXX-C 24 B3 MXX-C 30 B3 MXX-C 36 B3 MX**Energy:**Battery

BX 3-ME (02) Battery-actuated tool for mechanical and electrical applications



Fastener:

X-S 14 B3 MX

X-P 17 B3 MX

X-P 20 B3 MX

X-P 24 B3 MX

X-C 20 B3 MX

X-C 24 B3 MX

X-EHS MX

X-ECC MC

X-HS-W MX

X-EKB MX

X-FB MX

X-DFB MX

X-ECT MX

X-ET MX

X-EKS MX

X-EMTSC MC

X-ECH MX

X-UCT MX

X-DHS MX

X-ECH FE MX

X-EKB FE MX

X-SW MX

Energy:

Battery

BX 3-L (03) Battery-actuated tool for interior finishing applications



Fastener:

X-S 14 B3 MX

X-P 17 B3 MX

X-P 20 B3 MX

X-P 24 B3 MX

X-C 20 B3 MX

X-C 24 B3 MX

X-C 30 B3 MX

X-C 36 B3 MX

Energy:

Battery

BX 3 (03) Battery-actuated tool for interior finishing applications



Fastener:

X-S 14 B3 MX

X-P 17 B3 MX

X-P 20 B3 MX

X-P 24 B3 MX

X-C 20 B3 MX

X-C 24 B3 MX

X-C 30 B3 MX

Energy:

Battery

BX 3-ME (03) Battery-actuated tool for mechanical and electrical applications



Fastener:

X-S 14 B3 MX

X-P 17 B3 MX

X-P 20 B3 MX

X-P 24 B3 MX

X-C 20 B3 MX

X-C 24 B3 MX

X-EHS MX

X-ECC MC

X-HS-W MX

X-EKB MX

X-FB MX

X-DFB MX

X-ECT MX

X-ET MX

X-EKS MX

X-EMTSC MC

X-ECH MX

X-UCT MX

X-DHS MX

X-ECH FE MX

X-EKB FE MX

X-SW MX

Energy:

Battery



Part 4:

Fasteners

X-ENP Siding and decking nail

Product data

Dimensions

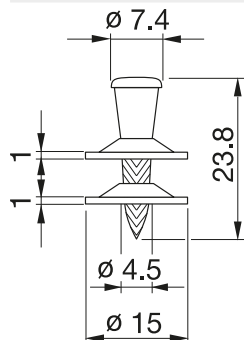

Material specifications

Carbon steel shank: HRC 58
 Zinc coating: 8-16 μm

Recommended fastening tools

Tools: Single nail:
 DX 76 F15, DX 76 PTR with X-ENP-19 L15
 X-76-F15-PTR fastener guide

Tools: Collated nails:
 DX 76 MX, DX 76 PTR X-ENP-19 L15 MX,
 white magazine strip
 DX 860-ENP, DX 9-ENP X-ENP-19 L15 MXR,
 grey magazine strip

- For more details, please refer to the chapter **Accessories and consumables compatibility** in the Direct Fastening Technology Manual (DFTM).

Approvals and certificates

ETA-04/0101 (Hilti-DX-DoP001), UL R13203, FM 3021719, ICC ESR-2197, ESR-2776 (USA), MLIT (Japan), ABS, LR 97/00077

- Not all information presented in this product data sheet might be subject to approval/certificate content. Please refer to approval/certificate for further information.

Applications

Examples

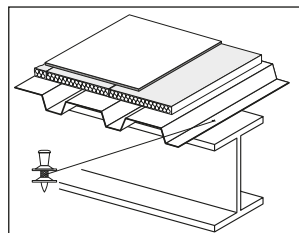

Roof decking

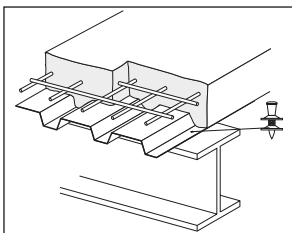

Floor decking

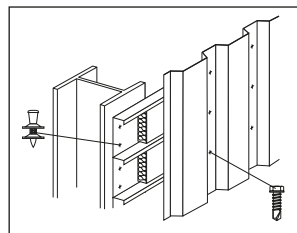

Wall liners

The intended use only comprises fastenings which are not directly exposed to external weather conditions or moist atmospheres. For out-door applications, that can be ensured by using SDK2 sealing caps. During construction exposure to external atmosphere must not exceed 6 months. Fastening of aluminum sheeting is generally recommended only for indoor conditions.

Performance data

Characteristic loads – steel sheeting

Sheeting thickness t_i [mm]	Trapezoidal profile (symmetric loading)		Liner trays ¹⁾ (asymmetric loading)	
	Char. resistance according to ETA-04/0101		Char. resistance keeping to ETA-04/0101	
nominal	Shear V_{Rk} [kN]	Tension N_{Rk} [kN]	Shear V_{Rk} [kN]	Tension N_{Rk} [kN]
0.75	4.70	6.30	3.30	4.40
0.88	5.40	7.20	3.80	5.00
1.00	6.00	8.00	4.20	5.60
1.13	7.00	8.40	4.90	5.90
1.25	8.00	8.80	5.60	6.20
1.50	8.60	8.80	6.00	6.20
1.75	8.60	8.80	6.00	6.20
2.00	8.60	8.80	6.00	6.20
2.50	8.60	8.80	6.00	6.20

- N_{Rk} and V_{Rk} are valid for steel sheet with minimum tensile strength ≥ 360 N/mm² (\geq S280 EN 10346).
 - For intermediate sheet thicknesses, use recommended load for next smaller thickness or linear interpolation.
- 1) Required load reduction is taken into account in accordance with EN 1993-1-3: 2006, section 8.3 (7) and fig. 8.2. See also construction rules under spacings and edge distances.

Recommended loads – steel sheeting

Sheeting thickness t_i [mm]	Trapezoidal profile (symmetric loading)		Liner trays ¹⁾ (asymmetric loading)	
	Recommended loads		Recommended loads	
nominal	Shear V_{rec} [kN]	Tension N_{rec} [kN]	Shear V_{rec} [kN]	Tension N_{rec} [kN]
0.75	2.50	3.35	1.75	2.35
0.88	2.90	3.85	2.00	2.70
1.00	3.20	4.25	2.25	3.00
1.13	3.75	4.50	2.65	3.15
1.25	4.25	4.70	3.00	3.30
1.50	4.60	4.70	3.20	3.30
1.75	4.60	4.70	3.20	3.30
2.00	4.60	4.70	3.20	3.30
2.50	4.60	4.70	3.20	3.30

- N_{rec} and V_{rec} are valid for steel sheet with minimum tensile strength ≥ 360 N/mm² (\geq S280 EN 10346).
 - For intermediate sheet thicknesses, use recommended load for next smaller thickness or linear interpolation.
 - Recommended loads N_{rec} and V_{rec} are appropriate for Eurocode 1 wind loading design with a partial safety factor $\gamma_F = 1.5$ for wind load and a partial resistance factor $\gamma_M = 1.25$ for the fastening.
- 1) Required load reduction is taken into account in accordance with EN 1993-1-3: 2006, section 8.3 (7) and fig. 8.2. See also construction rules under spacings and edge distances.

Recommended loads – aluminum sheeting¹⁾ with $f_u \geq 210 \text{ N/mm}^2$

Trapezoidal profile (symmetric loading)

Thickness t_f [mm]	Shear V_{rec} [kN]	Tension N_{rec} [kN]
0.60	0.75	0.35
0.70	0.90	0.50
0.80	1.00	0.65
0.90	1.20	0.80
1.00	1.30	0.95
1.20	1.55	1.30
1.50	1.85	1.45
2.00	2.55	1.90

- 1) Only recommended for indoor applications. Constraint forces and corrosion aspects have to be considered.
- For intermediate sheet thicknesses, use recommended load for next smaller thickness.
- Recommended loads N_{rec} and V_{rec} are appropriate for Eurocode 1 wind loading design with a partial safety factor of $\gamma_F = 1.5$ for wind load and a partial resistance factor $\gamma_M = 1.25$ for the fastening.

Recommended loads – other applications

	V_{rec} [kN]	N_{rec} [kN]
	4.6	2.4

- **Fastened parts:** clips, brackets, etc.; thick steel parts ($t_{l,max} = 2.5 \text{ mm}$).
- Redundancy (multiple fastening) must be provided.
- The possibility of prying effects has to be considered
- Failure of the fastened part is not considered in these values of N_{rec} , V_{rec} .
- Valid for predominantly static loading
- Global factor of safety is ≥ 2 based on 5% fracture value

Design

Depending on the verification concept, the corresponding design criteria are given as following.

Working load concept	Partial safety concept
Tensile loads $N_{Sk} \leq N_{rec}$	$N_{Sd} \leq N_{Rd}$
Shear loads $V_{Sk} \leq V_{rec}$	$V_{Sd} \leq V_{Rd}$

N-V Interaction

For combined tensile and shear forces on the fastener, a linear function has to be used.

$$\left(\frac{V_{Sk}}{V_{rec}}\right) + \left(\frac{N_{Sk}}{N_{rec}}\right) \leq 1$$

with:

V_{Sk} , N_{Sk} unfactored characteristic load acting on the fastening (= working load)

V_{rec} , N_{rec} recommended (allowable) load with $\gamma_{GLOB} = 1.875$

$$\left(\frac{V_{Sd}}{V_{Rd}}\right) + \left(\frac{N_{Sd}}{N_{Rd}}\right) \leq 1$$

with:

V_{Sd} , N_{Sd} Design load with $\gamma_F = 1.5$

V_{Rd} , N_{Rd} Design resistance of the fastening with $\gamma_M = 1.25$

$V_{Rd} = V_{Rk} / 1.25$

$N_{Rd} = \alpha_{cycl} N_{Rk} / 1.25$

$\alpha_{cycl} = 1.0$ according to ETA-04/0101

Application recommendation

Thickness of base material

Steel thickness t_{II}

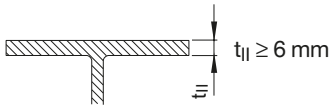

Thickness of fastened material

$\Sigma t_{I, \text{tot}} \leq 4.0 \text{ mm}$

Sheet thicknesses and overlap types

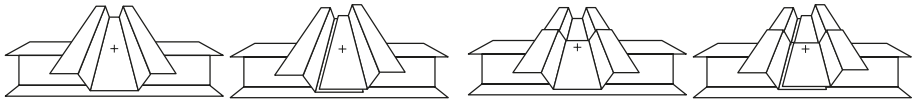

(a)
single

(b)
side lap

(c)
end overlap

(d)
side lap and end overlap

Nominal sheeting thickness t_I

0.63–1.00 mm

> 1.00–1.25 mm

> 1.25–2.50 mm

Allowable overlap types

a, b, c, d

a, c

a

With the above recommended sheet thickness and overlap types, it is not necessary to take into account the effect of constraints due to temperature for steel grades up to S320 (EN 10346). For steel grade S350 (EN 10346) it shall be considered for design. Sheets of grade S350 on base material $t_{II} \geq 8 \text{ mm}$ have been verified by Hilti, forces of constraint can be neglected.

Spacing and edge distances (mm)

Steel base material

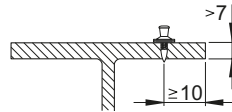
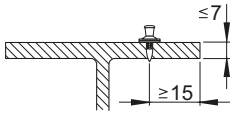

Trapezoidal profiles

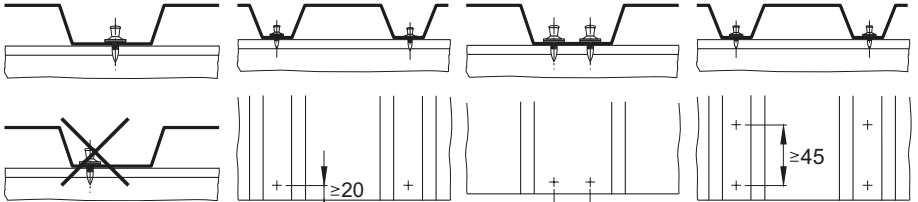

Centre fastenings in ribs

Clearance to end of sheet

Double fastenings (asymmetric)

Note: Reduce tensile resistance per fastener to $0.7 N_{Rk}$ or $0.7 N_{rec}$.

Liner trays

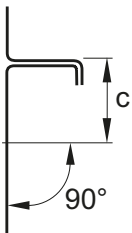

Clearance to side of sheet

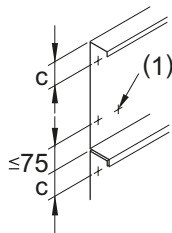

Clearance to side of sheet

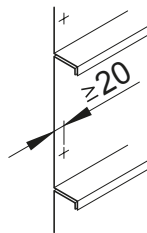

Clearance to end of sheet

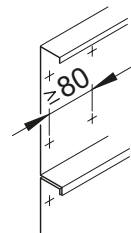

Fastener spacing along sheet

When driving the fastener, the fastening tool needs to be positioned perpendicular to the surface.
If $c > 75$ mm, it is recommended to drive an additional fastener at the other side of the tray. This additional fastener is indicated with (1) in the graph above.

Application limit

X-ENP-19 with DX 76, DX 76 PTR, DX 860-ENP and DX 9-ENP

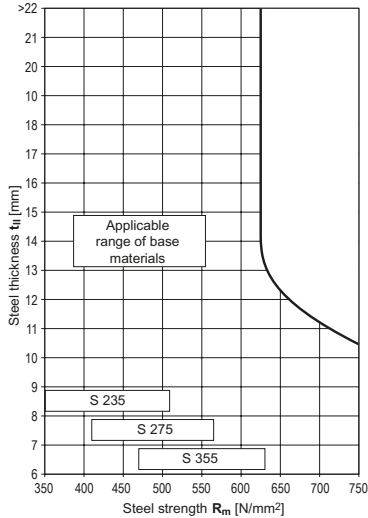

Corrosion information



- The intended use only comprises fastenings which are not directly exposed to external weather conditions or moist atmospheres.
- For outdoor applications that can be ensured by using SDK2 sealing caps.
- During construction exposure to external atmosphere must not exceed 6 months.
- Fastening of aluminum sheeting is generally recommended only for indoor conditions.
- For more details, please refer to following technical document: Hilti Corrosion Handbook.

Fastener program and system recommendation

Fasteners	Fastener		Tools	Fastener guide
	Designation	Item no.	Designation	Designation
Single nail:	X-ENP-19 L15	283506	DX 76 PTR DX 76 F15	X-76-F15-PTR
Collated nails:	X-ENP-19 L15 MX, white magazine strip	283507	DX 76 PTR DX 76 MX	
	X-ENP-19 L15 MXR, grey magazine strip	283508	DX 860-ENP	
Piston:	X-76-P-ENP-PTR		DX 76 PTR	
	X-76-P-ENP		DX 76 DX 860-ENP	
	X-9-ENP kit		DX 9-ENP	

Cartridge selection and tool energy setting

DX 76, DX 860-ENP, DX 9-ENP

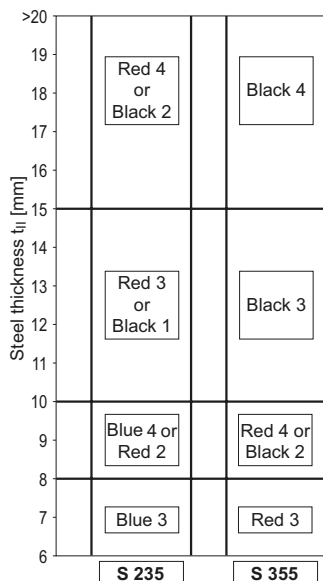

DX 76 PTR

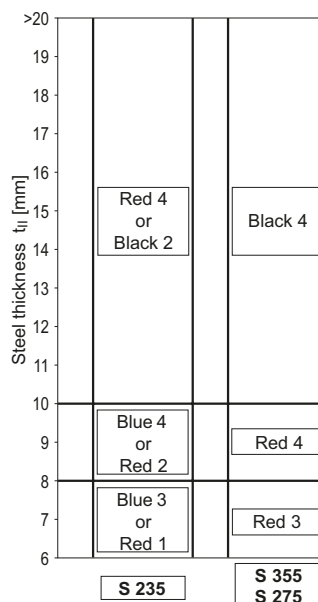

Fine adjustment by installation tests on site.

Note for S275:

Start with recommendation for S355. In case of too much energy: reduction of tool energy setting or change of cartridge colour till correct nail head stand-offs h_{NV5} are achieved.

Quality assurance

Fastening inspection

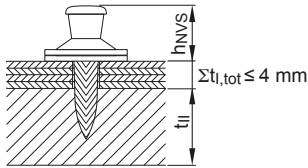

$h_{NVS} = 8.2-9.8 \text{ mm}$ for $t_{i,tot} \leq 4 \text{ mm}$

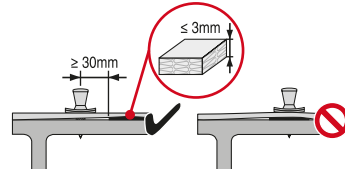

In order to allow the steel sheeting to be in direct contact with the steel supporting structure in the area of connections the X-ENP-19 fastener should be installed $\geq 30\text{mm}$ away from the edges of insulation / isolation tapes that are $\leq 3\text{mm}$ thick.

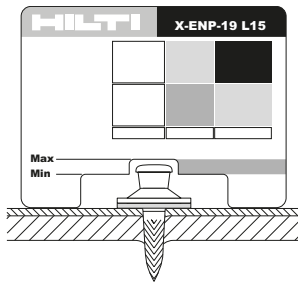

$h_{NVS} = 8.2-9.8 \text{ mm}$

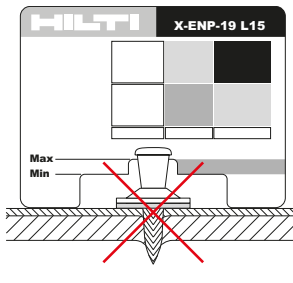

$h_{NVS} > 9.8 \text{ mm}$
(washers are not compressed)

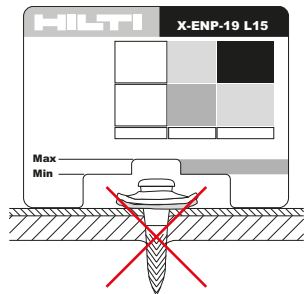

$h_{NVS} < 8.2 \text{ mm}$
(washers are strongly damaged by the tool piston)

Visual inspection

Issue	Visual	Criteria	Trouble	Possible cause	Action
Nail stand-off too high		No piston mark visible, nail head stays off, stand-off too high	Deck is not fastened properly to the beam	Power setting too low or cartridge not strong enough	Dial up power setting or increase strength of cartridge
Nail stand-off is OK		Washer compressed, piston mark clearly visible, deck flat – no deformation	–	–	–
Nail stand-off is too low		Washer over compressed, deck deformed, stand-off too low	Deck is not fastened properly to the beam	Power setting too high or cartridge is too strong	Dial down power setting or decrease strength of cartridge
Gap between deck profile and beam		Nail stand off OK or too low without piston clear mark	Deck profile does not lay solid on the beam	Gap caused by slope of the deck or local effects	Avoid gap between sheet and beam or fasten at the right side of the beam
Beam miss		Nail stand off OK or too low, sheet metal one sided deformed (edge of the beam visible)	Beam miss	Deck not marked	Mark the deck

SDK2, PDK2 Sealing cap for cladding fastening

Product data

Dimensions

SDK2 sealing cap

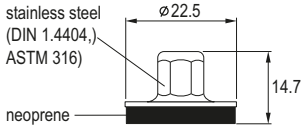

PDK2

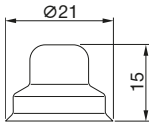

General information

Compatible DX fasteners

X-ENP-19 L15

Base material thickness $t_{II} \geq 6$ mm

Fastening tool

SW/SDK2 setting tool **SDK2**

SW/PDK2 setting tool **PDK2**

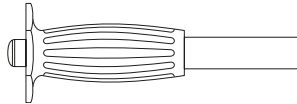

Applications

Examples

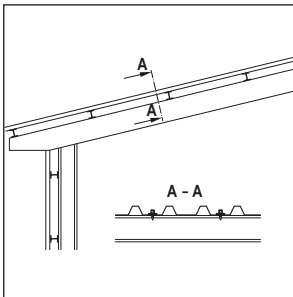

Roof and wall cladding on single skin buildings

SDK2, stainless steel sealing cap for roof and wall cladding

Stainless steel cap for mildly corrosive environments (C3)

Space under the cap isolated from the atmosphere

Neoprene washer insulates against contact corrosion and seals the space under the cap-off from the atmosphere

Pressure on the washer seals the gap between the sheet and the base steel

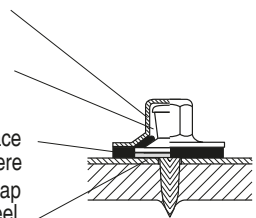

PDK2, plastic sealing cap for wall cladding

Corrosion protection

Fastening quality assurance
Fastening inspection

For detailed information on X-ENP-19 L15 please see the according product pages.

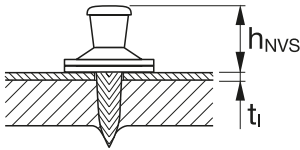
X-ENP-19 L15

Maximum thickness of single layer (type a):
 $t_{i, \max} = 1.5 \text{ mm}$
 Total thickness of end overlap (type c):
 $\Sigma t_{i, \text{tot}} \leq 2.5 \text{ mm}$

 $h_{NVS} = 8.2\text{--}9.8 \text{ mm}$

Note:

It has to be ensured, that the fastened sheet is properly compressed to the base material and no gap remains at fastening point location.

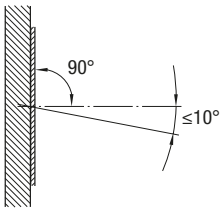
Installation

Position the DX tool so that nail inclination is limited to max. 10° from perpendicular to surface

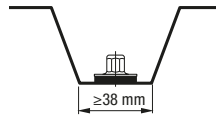
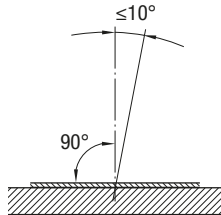

Centre fastening in valley.
 38 mm min. valley width

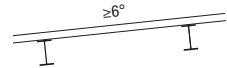

Minimum roof slope 6°

These are abbreviated instructions which may vary by application.

ALWAYS review/follow the instructions accompanying the product.

X-ENP 2K Siding and decking nail

Product data

Dimensions

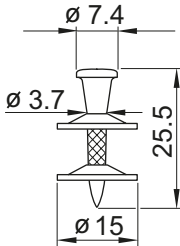

Material specifications

Carbon steel shank:	HRC 55.5
Zinc coating:	8–16 µm

Recommended fastening tools

Tools:	Single nail:
DX 76 PTR with	X-ENP 2K-20 L15
X-76-F-15-PTR fastener guide	
DX 76 MX with	
X-76-F-15 fastener guide	
Tools:	Collated nails:
DX 76 PTR	X-ENP 2K-20 L15 MX
DX 76 MX	(green magazine strip)

- For more details, please refer to the chapter **Accessories and consumables compatibility** in the Direct Fastening Technology Manual (DFTM).

Approvals and certificates

BUTgb (Belgium), ABS, ETA 13/0172 (Hilti-DX-DoP 003), LR 97/00077

- Not all information presented in this product data sheet might be subject to approval/certificate content. Please refer to approval/certificate for further information.

Applications

Examples

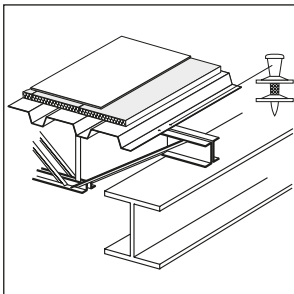

Roof and floor decking

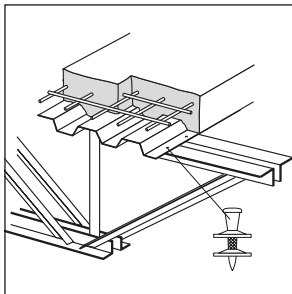

Roof and floor decking

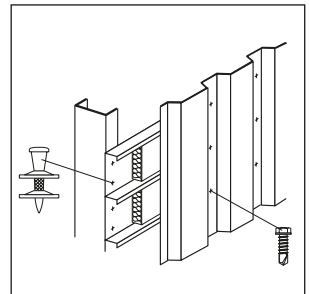

Wall liners

Performance data

Characteristic loads

Overlap Sheeting thickness t_l [mm]	$3 \text{ mm} \leq t_{ll} < 4 \text{ mm}$			$4 \text{ mm} \leq t_{ll} \leq 6 \text{ mm}$		
	V_{Rk} [kN]	N_{Rk} [kN]	Types of conn.	V_{Rk} [kN]	N_{Rk} [kN]	Types of conn.
0.75	4.70	6.00	a, c	4.70	6.30	a, b, c, d
0.88	5.40	6.00	a, c	5.40	7.20	a, (b)*, c, d
1.00	6.00	6.00	a, c	6.00	8.00	a, (b)*, c, d
1.13	–	–	–	7.00	8.40	a, c
1.25	–	–	–	8.00	8.80	a, c
1.50	–	–	–	8.60	8.80	a

* Fastening type (b) covered for $5 \text{ mm} \leq t_{ll} < 6 \text{ mm}$, if N_{Rk} is reduced to 6.6 kN

Fastening type (b) fully covered for $t_{ll} = 6 \text{ mm}$

For a, b, c, d please refer to Application requirements, Sheet thicknesses and overlap types

Design

Design shear and tension resistance

$$V_{Rd} = V_{Rk} / \gamma_M \quad N_{Rd} = \alpha_{cycl} N_{Rk} / \gamma_M \text{ with } \alpha_{cycl} = 1.0 \text{ for all sheeting thickness } t_l$$

α_{cycl} considers the effect of repeated wind loads

$\gamma_M = 1.25$ in the absence of national regulations

Characteristic tension resistances n_{Rk} [kN/m] and shear resistances v_{Rk} [kN/m] per unit length, taking the effect of thermal constraints into account

N_{Rk} and V_{Rk} characteristic shear and tension resistance

w ... width of the panel sheet

$$n_{Rk} = 0.9 \cdot 2 \cdot N_{Rk} / w \quad v_{Rk} = 2 \cdot V_{Rk} / w$$

$$n_{Rk} = 0.9 \cdot 3 \cdot N_{Rk} / w \quad v_{Rk} = 3 \cdot V_{Rk} / w$$

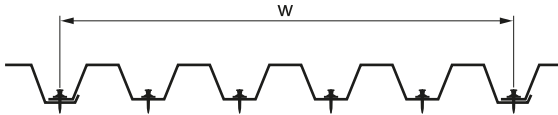

$$n_{Rk} = 0.9 \cdot 4 \cdot N_{Rk} / w \quad V_{Rk} = 4 \cdot V_{Rk} / w$$

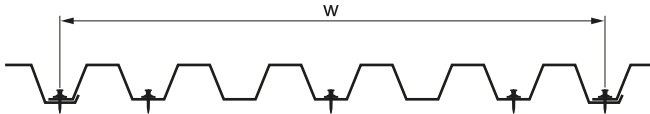

$$n_{Rk} = 0.9 \cdot 5 \cdot N_{Rk} / w \quad V_{Rk} = 5 \cdot V_{Rk} / w$$

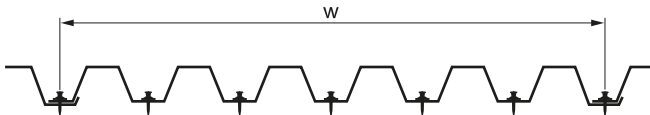

$$n_{Rk} = 3 \cdot N_{Rk} / w \quad V_{Rk} = 3 \cdot V_{Rk} / w$$

The same characteristic resistances can also be applied along supports at end-overlaps, if connection type “d” is not covered in the load table.

Application recommendation

Thickness of base material

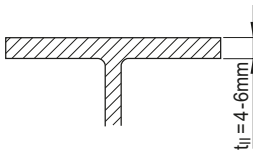

$t_{II} = 4.0 - 6.0$ mm for general shapes

Fastening to cold-formed C- and Z-sections with a thickness from 2.9 to 4.0 mm

Fastening to U-shape concrete inlays with a nominal thickness t_{II} of 3 mm.
 $t_{II} = 3.0 \pm 0.3$ mm

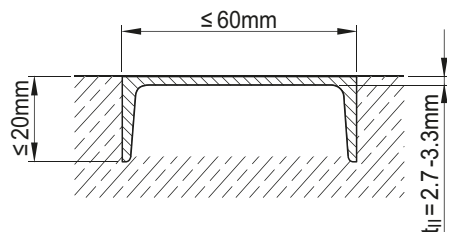
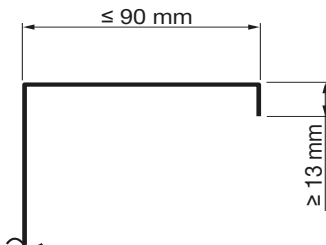

Grade: \geq S320 GD according to EN 10346

Sheet thicknesses and overlap types

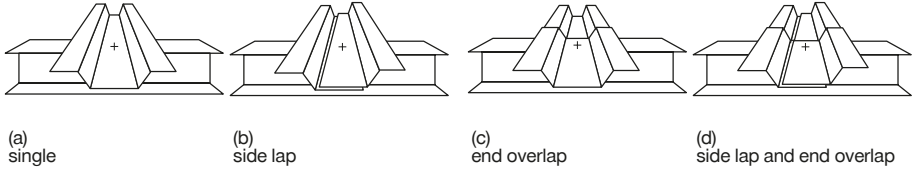

Edge distances (mm)

Rolled I or wide flange shapes

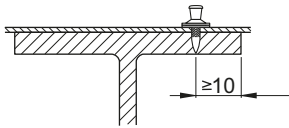

Angles

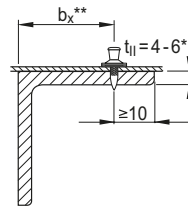

* For $t_{fl} = 3$ to 4 mm, restrictions on application. See approval or contact Hilti.

** Maximum recommended $b_x \leq 8 \times t_{fl}$ however, jobsite verification advisable.

Trapezoidal profiles

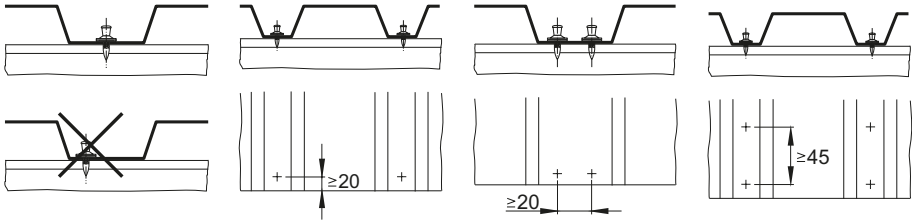

Centre fastenings in ribs

Clearance to end of sheet

Double fastenings
Note: Reduce tensile resistance per fastener to $0.7 N_{Rk}$.

Application limits

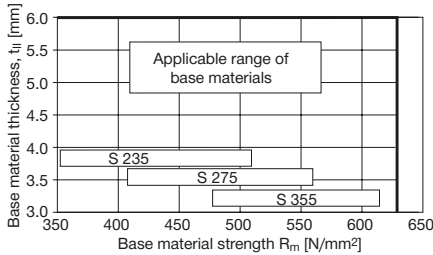

Corrosion information



- The intended use only comprises fastenings which are not directly exposed to external weather conditions or moist atmospheres.
- For more details, please refer to following technical document: Hilti Corrosion Handbook

Fastener program and system recommendation

Fasteners	Fastener		Tools	Fastener guide
	Designation	Item no.	Designation	Designation
Single nail:	X-ENP 2K-20 L15	385133	DX 76 PTR	X-76-F-15-PTR
			DX 76 MX	X-76-F-15
Collated nails:	X-ENP 2K-20 L15 MX	385134	DX 76 PTR DX 76 MX	
Piston:	X-76-P-ENP2K-PTR		DX 76 PTR	
	X-76-P-ENP2K		DX 76 MX	

Cartridge selection and tool energy setting

DX 76 PTR

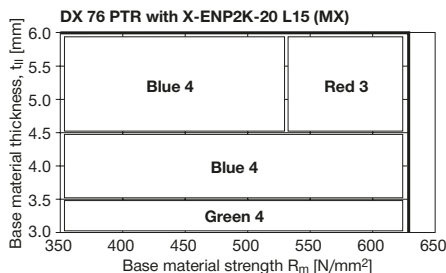

DX 76

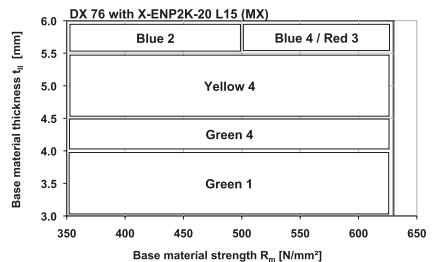

Fine adjustment by installation tests on site.

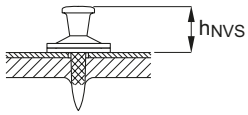
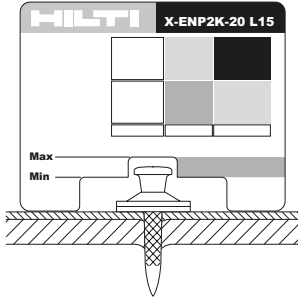
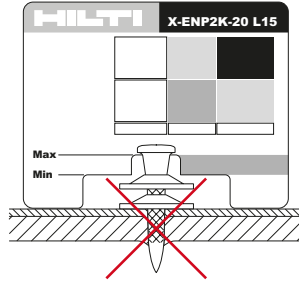
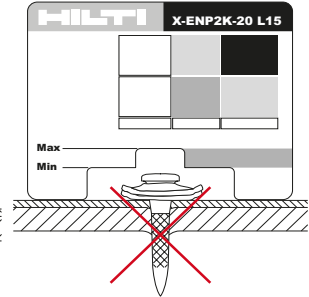
Quality assurance**Fastening inspection** $h_{NVS} = 7-11 \text{ mm}$  $h_{NVS} = 7-11 \text{ mm}$  $h_{NVS} > 11 \text{ mm}$  $h_{NVS} < 7 \text{ mm}$

X-HSN 24 Diaphragm decking nail

Product data

Dimensions

X-HSN 24

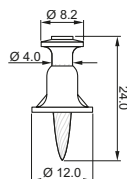

X-EDNK22 THQ12 M

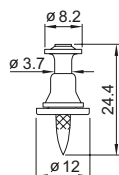

X-EDN19 THQ12 M

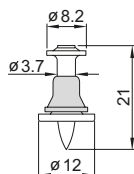

Material specifications

Carbon steel shank:	HRC 55.5
Zinc coating:	5–13 µm

Recommended fastening tool

Tools:	Collated nails:
DX 860-HSN, DX 9-HSN	X-HSN 24, red magazine strip X-EDNK22 THQ12 M, grey magazine strip X-EDN19 THQ12 M, white magazine strip

- For more details, please refer to the chapter **Accessories and consumables compatibility** in the Direct Fastening Technology Manual (DFTM).

Approvals and certificates

FM, SDI, UL, ICC, ABS, LR

- Not all information presented in this product data sheet might be subject to approval/certificate content. Please refer to approval/certificate for further information.

Applications

Examples

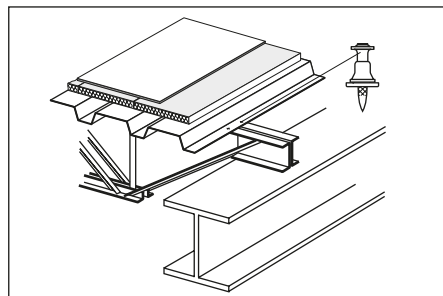

Roof decking (diaphragm design)

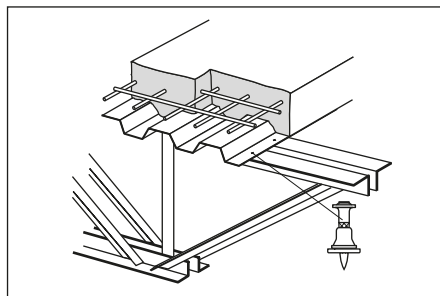

Floor decking (diaphragm design)

Performance data
Design data for use in the USA – Diaphragm strength

Approvals provide load tables or calculation procedures for determination of the allowable strength (in lbs/ft or kN/m) of a steel deck diaphragm. The allowable diaphragm strength depends on the type, strength and thickness of the decking, the span of the decking, the type and pattern of the deck to frame fasteners (X-HSN24, X-EDNK22 or X-EDN19) and the type and spacing of the sidelap connectors (e.g. Hilti sidelap connectors S-SLC 01 and S-SLC 02).

For more details it is referred to the technical literature of Hilti North America (“Steel Deck Fastening Systems” Hilti North America Product Technical Guide) and the “Decking Design Center” offered on the website www.us.hilti.com as well as the respective approvals.

Recommended shear bearing loads V_{rec}

Sheeting thickness t_f		X-HSN24, X-EDNK22 and X-EDN19	
[Gauge]	[mm]	V_{rec} [lbs]	[kN]
22	0.76	500	2.20
20	0.91	600	2.64
18	1.21	785	3.45
16	1.52	975	4.29

- Valid for steel sheet with a minimum tensile strength of 45 ksi (310 N/mm²). Values refer to failure controlled by the single sheet metal attached.
- For intermediate sheet thicknesses, linear interpolation is allowed.
- Recommended loads include safety factor 3.0 applied to mean shear resistance Q_f . An equation for Q_f is published in the SDI (Steel Deck Institute) Diaphragm Design Manual, 3rd edition.

Recommended tension load N_{rec}

Sheeting thickness t_f		X-HSN24, X-EDNK22		X-EDN19	
[Gauge]	[mm]	N_{rec} [lbs]	[kN]	N_{rec} [lbs]	[kN]
22	0.76	355	1.56	340	1.52
20	0.91	435	1.95	340	1.52
18	1.21	435	1.95	340	1.52
16	1.52	435	1.95	340	1.52

- Valid for steel sheet with minimum tensile strength of 45 ksi (310 N/mm²). Values are either controlled by pullover of sheet or by minimum value of fastener pullout of base metal.
- Values require fastener point penetration for X-EDNK22 and X-EDN19, of $1/8$ (12.7 mm). Higher recommended values be applicable for X-HSN24 (see Hilti North America “Steel Deck Fastening Systems”)
- Recommended loads include a safety factor 3.0 applied to mean pullover resistance or a safety factor 5.0 applied to the mean value of pullout resistance.

Design data for use in Europe

Currently, the X-HSN24, X-EDNK22 and the X-EDN19 fasteners are only used in North America. Therefore, no design data is published evaluated in strict compliance with the provisions for European Technical Approvals.

For European markets, the fastener X-ENP2K-20 L15 in connection with the fastening tools DX 76 or DX 76 PTR are recommended for sheet metal fastenings to thin base materials (3 to 6 mm).

Application recommendation
Fastening tool DX 860-HSN, DX 9-HSN

Fastener	Base material properties		Ultimate tensile strength	
	Thickness [inch]	[mm]	[ksi]	[N/mm ²]
X-EDNK22	$\frac{1}{8}''$ to $\frac{1}{4}''$	3.2 to 6.35	58 to 91	400-630
X-EDN 19	$\frac{3}{16}''$ to $\frac{5}{16}''$	4.8 to 8.0	58 to 91	400-630
	$\frac{5}{16}''$ to $\frac{3}{8}''$	8.0 to 9.5	58 to 68	400-470

- Comment on fastening tool DX 460-SM and DX 5-SM: This fastening tool is recommended for base material thickness from $\frac{3}{16}''$ to $\frac{3}{8}''$ (4.8 to 8.0 mm). The same strength limits apply as with the DX 860-HSN and DX 9-HSN.
- X-HSN24 covers full range of the fasteners X-EDNK22 and X-EDN19.

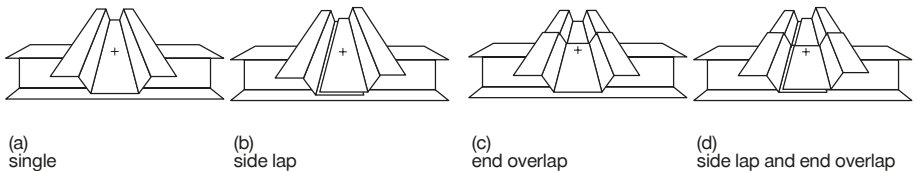
Thickness of fastened material, fastener patterns, spacings and edge distance

As part of a steel deck diaphragm, all four fastening types (a), (b), (c) and (d) are executed with the X-HSN 24, X-EDNK22 and the X-EDN19. The sheet metal thickness typically varies between 22 Gauge (0.76 mm) and 16 Gauge (1.52 mm).

Dependent on the base material thickness and the frame fastener pattern, restrictions on the use of thicker decking might apply. For corresponding details of these provisions, it is referred to the quoted technical literature published by Hilti North America. This literature also contains details with respect to fastener patterns, spacings and edge distance adequately addressing the specifics of the diaphragm components used in the North American market.

Corrosion information

- The intended use only comprises fastenings which are not directly exposed to external weather conditions or moist atmospheres.
- For more details, please refer to following technical document: Hilti Corrosion Handbook.

Fastener program and system recommendation

Fasteners	Designation	Item no.	Tool
Collated nails	X-HSN24	2042971	
	X-EDNK22 THQ12 M, grey magazine strip	34133	DX 860-HSN DX 9-HSN
	X-EDN19 THQ12 M, white magazine strip	34134	

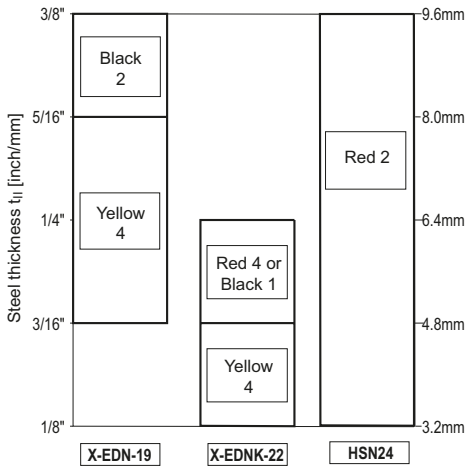
Cartridge selection and tool energy setting

Fine adjustment by installation tests on site.

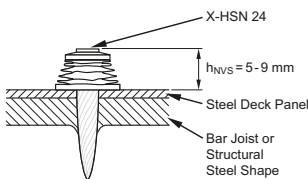
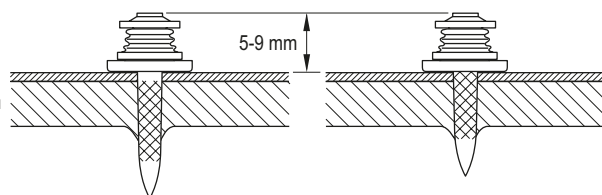
Quality assurance
Fastening inspection
X-HSN 24

X-EDNK22 THQ12 / X-EDN19 THQ12

NPH Siding and decking nail

Product data

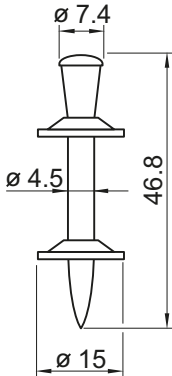
Dimensions



Material specifications

Carbon steel shank:	HRC 58
Zinc coating:	8-16 μm

Recommended fastening tools:

Tools:	Cartridges:
DX 76 PTR	6.8/18M blue
with DX 76-F-Kwik-PTR	
fastener guide	
DX 76 with X-76-F-Kwik	
fastener guide	

- For more details, please refer to the chapter **Accessories and consumables compatibility** in the Direct Fastening Technology Manual (DFTM).

Approvals and certificates

SOCOTEC (France), BUtgb (Belgium)

- Not all information presented in this product data sheet might be subject to approval/certificate content. Please refer to approval/certificate for further information.

Applications

Examples

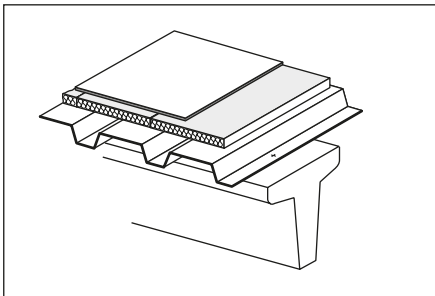

Roof decking

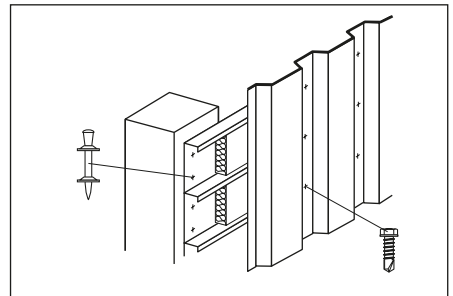

Wall liners

Performance data

Recommended loads

Sheeting thickness t_f [mm] nominal	Trapezoidal profile (symmetric)		Liner trays (asymmetric)	
	N_{rec} [kN]	V_{rec} [kN]	N_{rec} [kN]	V_{rec} [kN]
0.75	1.80	1.20	1.30	1.20
0.88	2.10	1.50	1.50	1.50
1.00	2.40	1.80	1.70	1.80
1.13	2.70	2.20	1.90	2.20
1.25	3.00	2.50	2.10	2.50
1.50	3.00	3.00	2.50	3.00
1.75	3.00	3.00	2.50	3.00
2.00	3.00	3.00	2.50	3.00

- Recommended working loads valid for steel sheets with a minimum tensile strength of $\geq 360 \text{ N/mm}^2$.
- For intermediate sheet thicknesses, use recommended load for next smaller thickness.
- Recommended loads are appropriate for EC1 (or similar) wind loading designs.
- The safety factor included is at least 2.0 applied to the static 5 % fractile value and 1.3 to the cyclic (5000 cycles) 5 % fractile value.

Application recommendation

Thickness of base material

Minimum thickness of concrete member $h_{min} = 160 \text{ mm}$

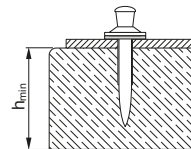

Thickness of fastened material

Sheet thicknesses and overlap types

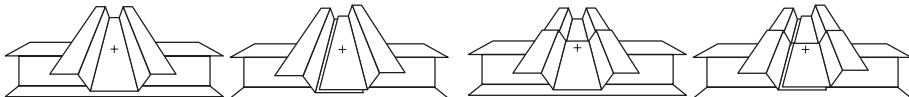

(a)
single

(b)
side lap

(c)
end overlap

(d)
side lap and end overlap

Nominal sheeting thickness t_f

0.63–1.13 mm

Allowable overlap types

a, b, c, d

> 1.13–2.50 mm

a

- With the above recommended sheet thickness and overlap types, the effects of temperature induced forces of constraint during construction can be neglected.
- These recommendations are valid for sheets up to S350GD.
- With other sheets or overlaps or when unusually large forces of constraint are expected, analyse the structural system to ensure that the shear force acting on the nail does not exceed V_{rec} .

Spacing and edge distances (mm)

Trapezoidal profiles to girders or purlins

Liner trays to columns

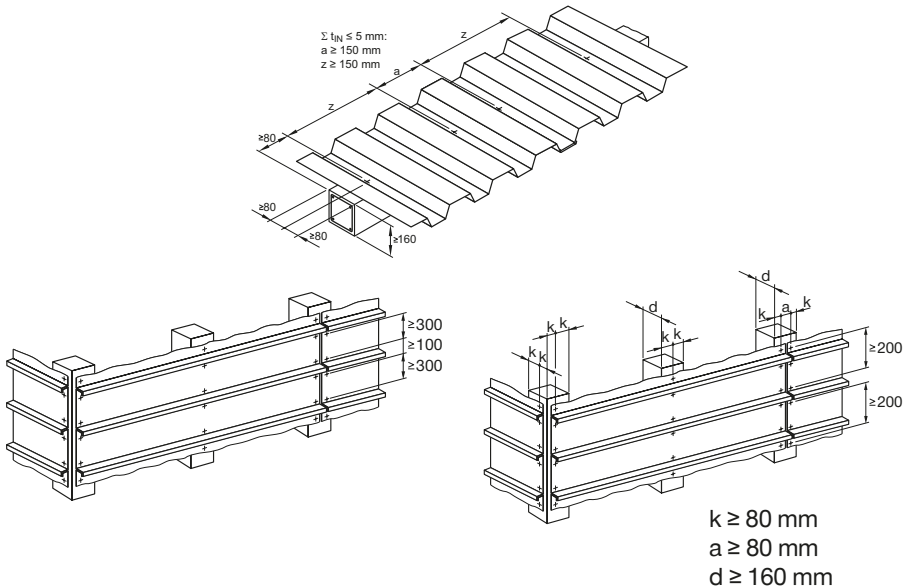

Application limits

Types of concrete	<ul style="list-style-type: none"> • Precast and cast-in-place pre-stressed concrete • Precast and cast-in-place reinforced concrete
Concrete design strength	<ul style="list-style-type: none"> • Minimum C20/25 ($f_c = 20 \text{ N/mm}^2$, $f_{cc} = 25 \text{ N/mm}^2$) • Maximum C45/55 ($f_c = 45 \text{ N/mm}^2$, $f_{cc} = 55 \text{ N/mm}^2$) • The NPH/DX-Kwik system has been successfully used in concrete having an in-place cube strength of 70 N/mm^2
Minimum strength/age at time of fastening	<ul style="list-style-type: none"> • C20/25 concrete must be 28 days old • C45/55 concrete must be 15 days old
Minimum dimensions of concrete member	<ul style="list-style-type: none"> • Minimum width = 180 mm • Minimum thickness = 160 mm

Corrosion information

- The intended use only comprises fastenings which are not directly exposed to external weather conditions or moist atmospheres.
- For more details, please refer to following technical document: Hilti Corrosion Handbook.

Fastener programm

Fasteners		Tool	Fastener guide	Piston
Designation	Item no.	Designation	Designation	Designation
NPH2-42 L15	40711	DX 76	X-76-F-Kwik	X-76-P-Kwik
		DX 76 PTR	X-76-F-Kwik-PTR	X-76-P-Kwik-PTR

Cartridge recommendation

Cartridges 6.8/18 M blue



- Tool power level adjustment by setting tests on site.
- Start tool energy selection with lowest recommended tool power level.
- Correct according requirement from chapter quality assurance.

Quality assurance

Installation

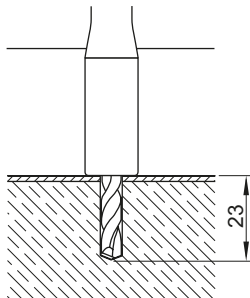

Pre-drill with TX-C-5/23 drill bit
(Item no.: 00061787)

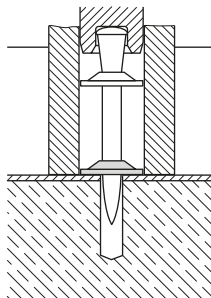

Place fastener with DX 76 PTR
or DX 76

Fastening inspection

NPH2-42 L15

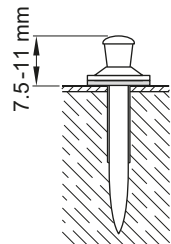

Check for conformity with recommendations
(detailing spacing and edge distances for fastening)

Check the nailhead standoff of completed fastenings

These are abbreviated instructions which may vary by application.
ALWAYS review/follow the instructions accompanying the product.

X-HVB Shear connector

Product data

Dimensions

X-HVB 140

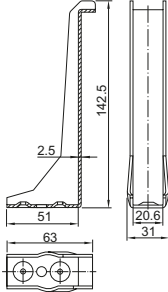

X-HVB 125

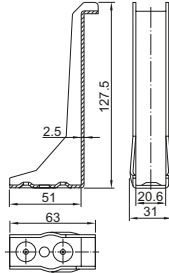

X-HVB 110

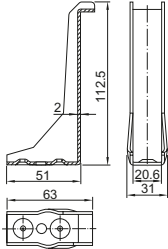

X-HVB 95

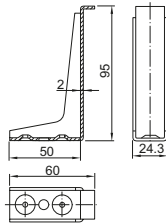

X-HVB 80

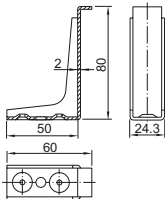

X-HVB 50

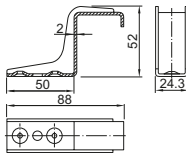

X-HVB 40

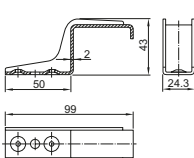

X-ENP-21 HVB

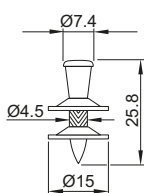

Material specifications

X-HVB

Carbon steel: $R_m = 295\text{--}350\text{ N/mm}^2$

Zinc coating: $\geq 3\ \mu\text{m}$

X-ENP-21 HVB

Carbon steel shank: HRC58

Zinc coating: $8\text{--}16\ \mu\text{m}$

Recommended fastening tools

Tool	DX 76	DX 76 PTR
Fastener guide	X-76-F-HVB	X-76-F-HVB-PTR
Piston	X-76-P-HVB	X-76-P-HVB-PTR
Cartridges	6.8/18M black, red (for details see application limit X-ENP-21 HVB)	

- For more details, please refer to the chapter **Accessories and consumables compatibility** in the Direct Fastening Technology Manual (DFTM).

Approvals and design guidelines

ETA-15/0876, design according to Eurocode 4 (EN 1994-1-1, EN 1994-1-2) and Eurocode 8 (EN 1998-1)

MLIT / BCJ (Japan)

- With regard to composite design according to AISC (American Institute of Steel Construction), please refer to the technical literature of Hilti North America (Product Technical Guide).

Applications

Examples

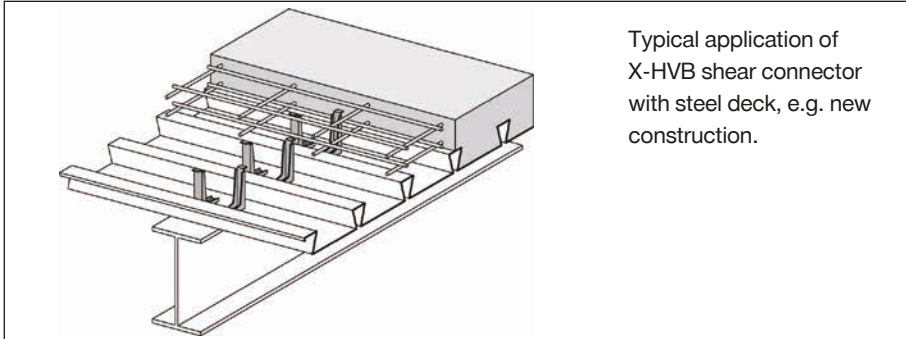

Typical application of X-HVB shear connector with steel deck, e.g. new construction.

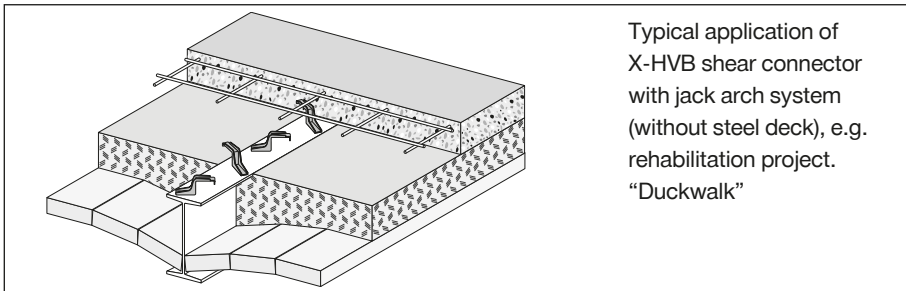

Typical application of X-HVB shear connector with jack arch system (without steel deck), e.g. rehabilitation project. "Duckwalk"

Characteristic and design resistance (ETA-15/0876) in composite beams with solid slabs

Shear Connector	Characteristic Resistance P_{Rk} [kN]	Design Resistance P_{Rd} [kN]	Minimum base material thickness [mm]	X-HVB positioning	Ductility assessment
X-HVB 40	29	23	6	"duckwalk"	Ductile according to EN 1994-1-1
X-HVB 50	29	23	6		
X-HVB 80	32.5	26	8 ^{*)}	parallel with beam	
X-HVB 95	35	28			
X-HVB 110	35	28			
X-HVB 125	37.5	30			
X-HVB 140	37.5	30			

*) Reduction to 6 mm possible, with regards to required reduction of design resistance see annex C3 of ETA-15/0876.

Conditions:

- Normal weight concrete C20/25 to C50/60
- Light weight concrete LC20/22 to LC50/55 with a minimum density $\rho = 1750 \text{ kg/m}^3$

Design resistance in composite beams with decking ribs transverse to beam axis

X-HVB positioning	Design Resistance $P_{Rd,t}$ [kN]	Ductility assessment
<p>X-HVB positioning longitudinal with the beam</p>	$P_{Rd,t,t} = k_{t,l} \cdot P_{Rd}$ $k_{t,l} = \frac{0.66}{\sqrt{n_r}} \cdot \frac{b_0}{h_p} \cdot \left(\frac{h_{SC}}{h_p} - 1 \right) \leq 1.0$	Ductile according to EN 1994-1-1
<p>X-HVB positioning transverse with the beam</p>	$P_{Rd,t,t} = 0.89 \cdot k_{t,t} \cdot P_{Rd}$ $k_{t,t} = \frac{1.18}{\sqrt{n_r}} \cdot \frac{b_0}{h_p} \cdot \left(\frac{h_{SC}}{h_p} - 1 \right) \leq 1.0$	

Conditions:

- Applicable for X-HVB 80, X-HVB 95, X-HVB 110, X-HVB 125, X-HVB 140
- n_r corresponds to the number of X-HVBs per rib ($n_r \leq 3$)

Design resistance in composite beams with decking ribs parallel to beam axis

X-HVB positioning	Design Resistance $P_{Rd,t}$ [kN]	Ductility assessment
<p>X-HVB positioning longitudinal with the beam</p>	$P_{Rd,t} = k_l \cdot P_{Rd}$ $k_l = 0.6 \cdot \frac{b_0}{h_p} \cdot \left(\frac{h_{SC}}{h_p} - 1 \right) \leq 1.0$	Ductile according to EN 1994-1-1

Conditions:

- Applicable for X-HVB 80, X-HVB 95, X-HVB 110, X-HVB 125, X-HVB 140
- X-HVB are to be positioned parallel with beam

Decking geometric parameters

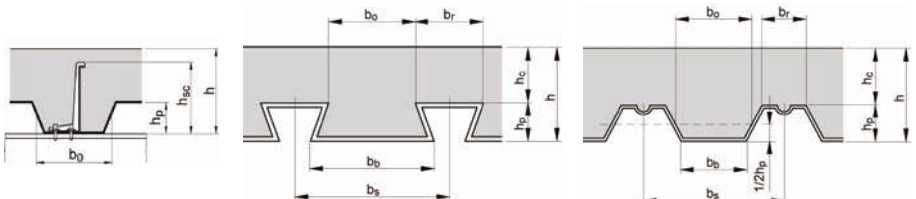

Design information

Connector placement along the beam

The X-HVB is a ductile shear connector according to EN 1994-1-1, section 6.6, and may be uniformly distributed between critical sections. These critical sections, where large changes in shear flow occur, may be at supporting points, points of application of point loads or areas with extreme bending moments.

Partial shear connection

Strength:

The minimum connection depends on the design code used:

In EN 1994-1-1 design, N/N_f must be at least 0.4. This increases depending on span length and decking geometry.

Deflection control only

If the shear connection is needed for deflection control only, there is no minimum degree of connection. However, minimum allowable connector spacing applies and the steel beam must have enough strength to carry the self-weight and all imposed loads.

Further specific design topics covered in the ETA-15/0876

- Coverage of seismic loading according to Eurocode 8 (EN 1998-1-1)
- Design resistance in case of use of old steel with an ultimate strength greater than 300 N/mm² and less than 360 N/mm²
- Effect of reduced base material thickness less than 8 mm for X-HVB 80 to X-HVB 140
- Design of end anchorage of composite slabs
- Design in case of a fire

Application recommendation

Thickness of base material

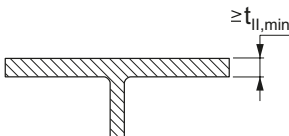

For beams with composite decking:
minimum thickness $t_{II} = 8$ mm.

For beams with solid concrete slabs:
minimum thickness $t_{II} = 6$ mm, especially relevant in renovation projects in order to take the thin flange thickness of small I-sections (e.g. IAO 100, I 100, IPE 100) into account.

Thickness of fastened material

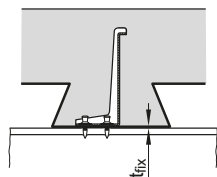

Maximum total thickness of fixed sheeting t_{fix} :

- 2.0 mm for X-HVB 80, X-HVB 95 and X-HVB 110
- 1.5 mm for X-HVB 125 and X-HVB 140

Positioning of X-HVB connectors in solid concrete slabs

X-HVB are to be positioned parallel with beam

1 row of connectors

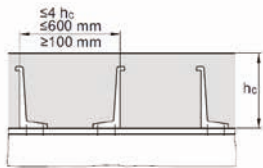

2 row of connectors

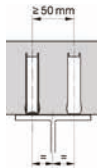
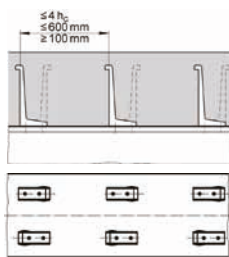

Maximum 3 row of connectors

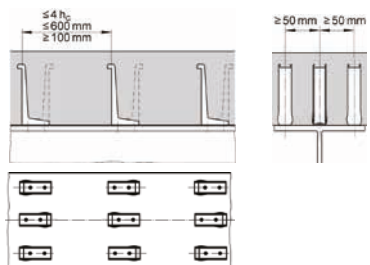

Positioning of X-HVB connectors with composite deck (deck positioned transverse to; and X-HVB positioned parallel with beam axis)

Spacing and positioning

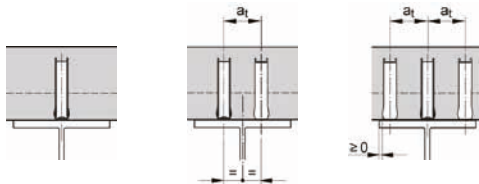

- $a_t \geq 50 \text{ mm}$ for compact profiled decking with $b_0/h_p \geq 1.8$
- $a_t \geq 100 \text{ mm}$ for other decking

1 row of connector - Minimum rib width and spacing to decking

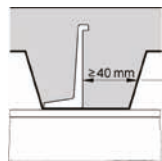
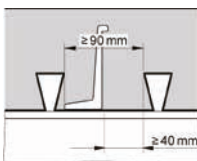

Rib width
<math>< 105 \text{ mm}</math>

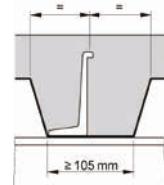

Rib width
$\ge 105 \text{ mm}$

Multiple rows of connector - Minimum rib width

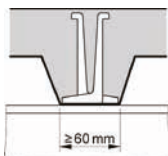

Positioning of X-HVB connectors with composite deck (deck and X-HVB positioned transverse to beam axis)

Spacing

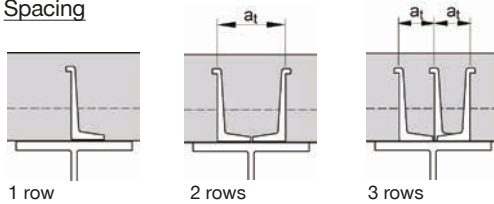

2 rows:

- $a_t \geq 100$ mm for all types decking

3 rows:

- $a_t \geq 50$ mm for compact profiled decking with $b_0/h_p \geq 1.8$
- $a_t \geq 100$ mm for other decking

Positioning - 1 row of connectors

Without rib stiffener

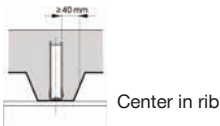

With rib stiffener (X-HVB in contact with rib stiffener)

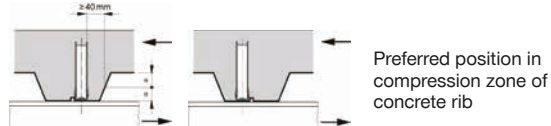

Positioning - 2 and 3 rows of connectors

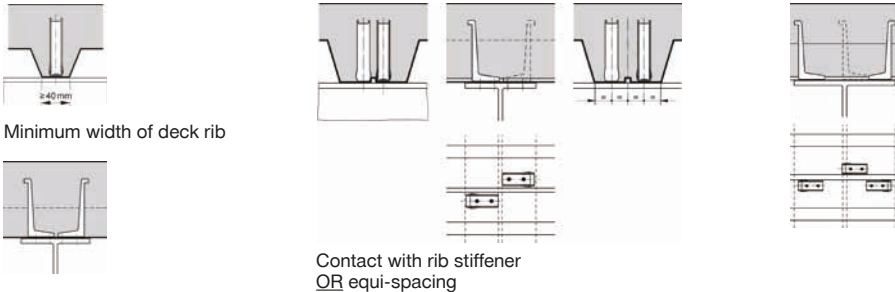

Positioning of X-HVB connectors with composite deck (deck parallel with beam axis)

X-HVB are to be positioned parallel with beam

Spacing and positioning

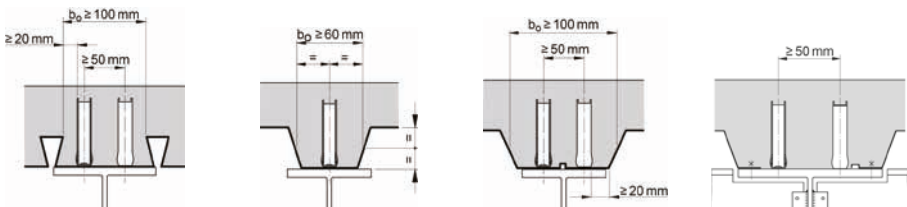

- If a centric positioning within the concrete rib is not possible due to the shape of the composite decking, the decking needs to be split.

“Duckwalk” positioning of X-HVB 40 and 50 in combination with thin solid slabs for renovation construction

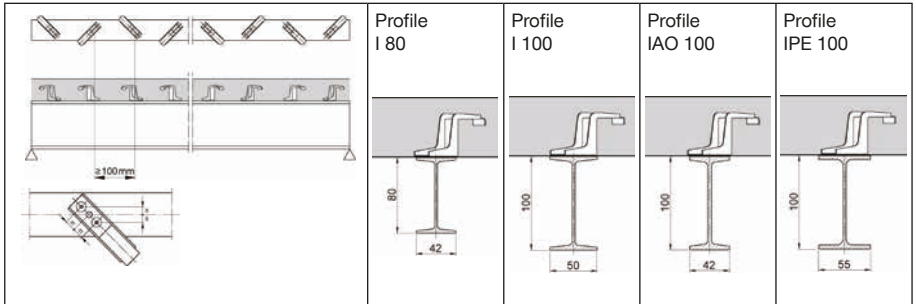

- Minimum section width = 40 mm (e.g. old section IAO 100)
- Minimum center distance of steel sections = 400 mm

Application limits

Application limits are valid only if correct cartridge and power setting are used!

Application limits X-ENP-21 HVB

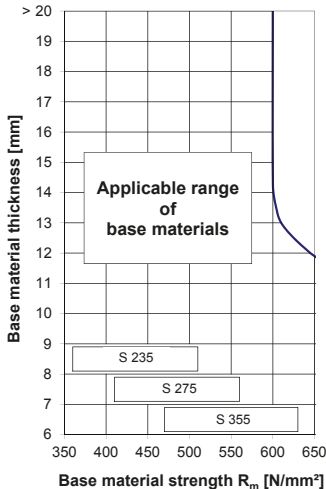

Cartridge preselection and power setting

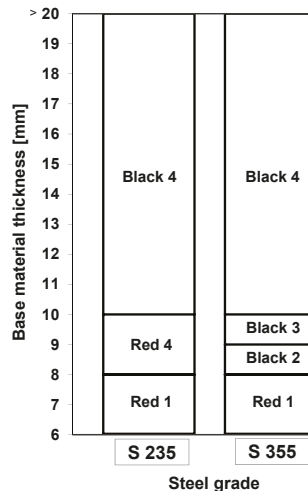

In thermo-mechanically rolled construction steel, e.g. S 355M per EN 10025-4 the application limit is reduced by 50 N/mm²

Fine adjustment by carrying out installation tests on site

- Minimum section covered: IPE 100
- Minimum base material thickness for beams with composite decking: 8 mm

Fastener program

Minimum slab thickness

X-HVB	Minimum slab thickness h [mm]	
	Without effect of corrosion	With effect of corrosion
40	50	60
50	60	70
80	80	100
95	95	115
110	110	130
125	125	145
140	140	160

Maximum decking height h_p , dependent on decking geometry

X-HVB	Maximum height of composite decking h_p [mm]		
	$\frac{b_o}{h_p} \geq 1.8$	$1.0 < \frac{b_o}{h_p} < 1.8$	$\frac{b_o}{h_p} \leq 1.0$ x)
80	45	45	30
95	60	57	45
110	75	66	60
125	80	75	73
140	80	80	80

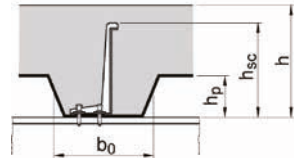

x) $b_0/h_p \geq 1.0$ for composite decking perpendicular to beam combined with X-HVB orientation parallel with beam

Quality assurance

Fastening inspection

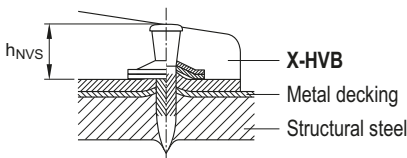

$$8.2 \text{ mm} \leq h_{NVS} \leq 9.8 \text{ mm}$$



Clearly visible piston mark on top washer

X-X Nail for fastening to concrete and steel

Product data

Product description

X-X MX



X-X P8



- Innovative Helix nail tip – for better drivability when fastening to tough concrete and steel.
- High hardness (58 HRC) nails for better penetration in tough concrete or steel.
- Optimized for use with Hilti tools – helps to secure sufficient guidance and energy for driving straight and deep into the base material.

Dimensions

Technical drawing	Designation	Shank length L_s	Head length L_h	Shank diameter d_s	Head diameter d_h
	X-X 22	22 mm	2.4 mm	4.4 mm	8.2 mm
	X-X 27	27 mm			
	X-X 34	34 mm			
	X-X 40	40 mm			
	X-X 47	47 mm			
	X-X 52	52 mm			
	X-X 57	57 mm			
	X-X 62	62 mm			
	X-X 72	72 mm			

Material specification and material properties for carbon steel elements

Designation	Element	Material	Coating	Minimum coating thickness	Hardness
X-X	Nail	Carbon steel	Zinc	5 μm	58 HRC

Applications

Fastening wood to concrete

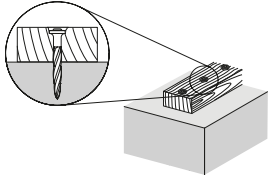

Fastening wood to steel

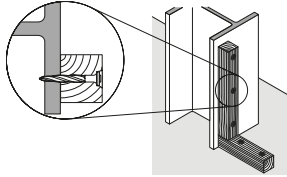

Fastening steel to concrete

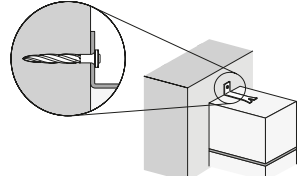

Base materials

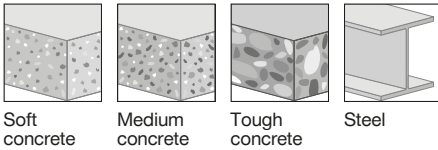

Soft
concrete

Medium
concrete

Tough
concrete

Steel

Load conditions



Static/
quasi static

Environmental conditions



Dry indoor

- The intended use comprises fastening in dry conditions.
- For more details, please refer to following technical document: Hilti Corrosion Handbook.

Fastener program

Item no. and description

Designation	Item no.	Description
X-X 22 MX	2312327	Collated nail
X-X 27 MX	2300016	
X-X 34 MX	2300018	
X-X 40 MX	2300019	
X-X 47 MX	2300020	
X-X 52 MX	2300021	
X-X 57 MX	2300022	
X-X 62 MX	2300023	
X-X 72 MX	2300024	
X-X 22 P8	2312326	Single nail
X-X 27 P8	2300007	
X-X 34 P8	2300009	
X-X 40 P8	2300010	
X-X 47 P8	2300011	
X-X 52 P8	2300012	
X-X 57 P8	2300013	
X-X 62 P8	2300014	
X-X 72 P8	2300015	

X-X Nail for fastening wood to concrete

Application recommendation

Fastened material properties and fastener positioning in fastened material

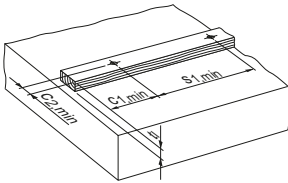

Fastened material	Wood
Fastened material thickness t_f	15–50 mm
Edge distance $c_{1,min}$	250 mm
Edge distance $c_{2,min}$	20 mm
Fastener spacing $s_{1,min}$	500 mm



- Edge distances and fastener spacing are recommendations to avoid splitting.

Base material properties and fastener positioning in base material

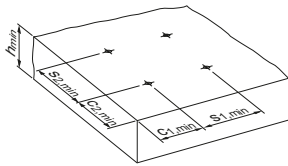

Base material	Concrete
Base material thickness h_{min}	80 mm
Edge distance $c_{1,min}, c_{2,min}$	70 mm
Fastener spacing $s_{1,min}, s_{2,min}$	100 mm



- For more details in relation to base material properties, please refer to the chapter **Fastener selection guide** in the Direct Fastening Technology Manual (DFTM).

Fastener shank length recommendation

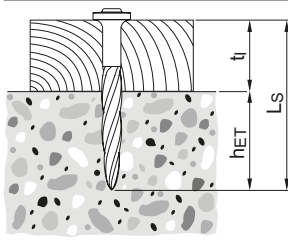

For standard fastening:	$L_s = h_{ET} + t_f$
For flush fastening:	$L_s = h_{ET} + t_f - 3 \text{ mm}$

Performance data

Recommended resistance under tension and shear load

Embedment depth h_{ET}	Tension load N_{rec}		Shear load V_{rec}	
	Soft/medium concrete	Tough concrete	Soft/medium concrete	Tough concrete
≥ 18 mm	0.25 kN	–	–	–
≥ 20 mm	0.35 kN	0.10 kN	0.35 kN	0.15 kN
≥ 25 mm	0.45 kN	0.15 kN	0.45 kN	0.25 kN

- Redundancy of fastening points is required.
- Minimum number of fastening points for safety relevant fastenings: ≥ 5 .

Stick rate estimation

	Designation	Soft/medium concrete	Tough concrete
	X-X	84–92 %	80–90 %

- The stick rate indicates the percentage of nails that were driven correctly to carry a load.
- Stick rate can vary from the above values depending on job site conditions.

System recommendation



- For more details, please refer to the chapter **Accessories and consumables compatibility** in the Direct Fastening Technology Manual (DFTM).

System recommendation for fastening collated nails with powder-actuated tool

Designation	Powder-actuated tool				Base material		
	DX 6 MX	DX 5 MX	DX 460 MX		Soft concrete	Medium concrete	Tough concrete
X-X 34 MX to X-X 72 MX	■	■	□		■	■	■

■ = recommended □ = feasible

System recommendation for fastening single nails with powder-actuated tools

Designation	Powder-actuated tool				Base material		
	DX 6 F8	DX 5 F8	DX 460 F8	DX 2	Soft concrete	Medium concrete	Tough concrete
X-X 34 P8 to X-X 72 P8	■	■	□		■	■	■
X-X 34 P8 to X-X 62 P8				■	■	■	□

■ = recommended □ = feasible

Cartridge recommendation

Base material	Cartridge color (tool power level)	
	Tool type: DX 6 MX DX 6 F8	Tool type: DX 5 MX, DX 460 MX DX 5 F8, DX 460 F8, DX 2 ¹⁾
	Cartridge type: 6.8/11 M	Cartridge type: 6.8/11 M
Soft/medium concrete	titanium ■ (2-8)	yellow ■, red ■
Tough concrete	titanium ■ (4-8), black ■ (7-8)	red ■, black ■

¹⁾ Black cartridges do not apply for this tool.

- Tool power level adjustment by setting tests on site.
- Start tool energy selection with lowest recommended tool power level.
- Correct according requirement from chapter quality assurance.

Quality assurance

Setting depth control and power tool adjustment

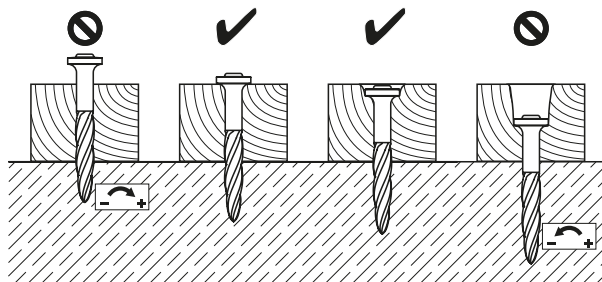

- Visible setting failures must be replaced with a new fastener, not in the same hole.
- These are abbreviated instructions which may vary by application.
- Always review/follow the instructions accompanying the product.

X-X Nail for fastening wood to steel

Application recommendation

Fastened material properties and fastener positioning in fastened material

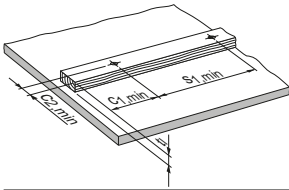

Fastened material	Wood
Fastened material thickness t_1	15–50 mm
Edge distance $c_{1,min}$	250 mm
Edge distance $c_{2,min}$	20 mm
Fastener spacing $s_{1,min}$	500 mm

Base material properties and fastener positioning in base material

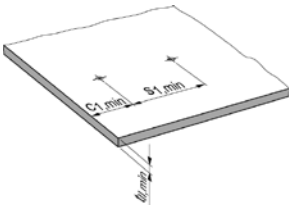

Base material	Steel
Base material thickness t_{II}	4–10 mm (for steel S235)
Base material thickness t_{II}	4–6 mm (for steel S275, S355)
Edge distance $c_{1,min}$	15 mm
Fastener spacing $s_{1,min}$	20 mm

Fastener shank length recommendation

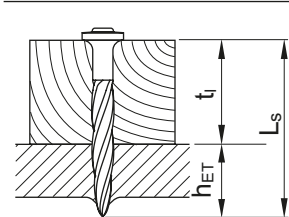

For standard fastening:	$L_s = h_{ET} + t_1$
For flush fastening:	$L_s = h_{ET} + t_1 - 3 \text{ mm}$

Application limitation for fastening on steel

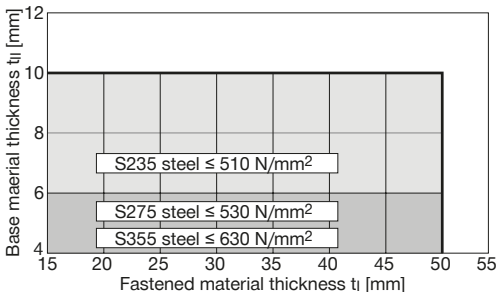

Performance data

Recommended resistance under tension and shear load

Embedment depth h_{ET}	Tension load N_{rec}	Shear load V_{rec}
≥ 7 mm	0.40 kN	0.60 kN

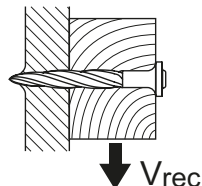
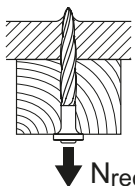

- i** • Redundancy of fastening points is required.
- Minimum number of fastening points for safety relevant fastenings: ≥ 5 .

System recommendation

- i** • For more details, please refer to the chapter **Accessories and consumables compatibility** in the Direct Fastening Technology Manual (DFTM).

System recommendation for fastening collated nails with powder-actuated tool

Designation	Powder-actuated tool			Base material		
	DX 6 MX	DX 5 MX	DX 460 MX	Steel S235	Steel S275	Steel S335
X-X 22 MX to X-X 62 MX	■	■	□	■	■	■

■ = recommended □ = feasible

System recommendation for fastening single nails with powder-actuated tools

Designation	Powder-actuated tool				Base material		
	DX 6 F8	DX 5 F8	DX 460 F8	DX 2	Steel S235	Steel S275	Steel S335
X-X 22 P8 to X-X 62 P8	■	■	□		■	■	■
X-X 22 P8 to X-X 62 P8				■	■	□	□

■ = recommended □ = feasible

Cartridge recommendation

Base material		Cartridge color (tool power level)	
		Tool type: DX 6 MX DX 6 F8	Tool type: DX 5 MX, DX 460 MX DX 5 F8, DX 460 F8, DX 2 ¹⁾
		Cartridge type: 6.8/11 M	Cartridge type: 6.8/11 M
S235 to S355	$4 \leq t_{\parallel} < 6 \text{ mm}$	titanium ■ (1-5)	green ■, yellow ■, red ■
	$6 \leq t_{\parallel} \leq 10 \text{ mm}$	titanium ■ (4-8), black ■ (7-8)	yellow ■, red ■, black ■

¹⁾ Black cartridges do not apply for this tool.

- Tool power level adjustment by setting tests on site.
- Start tool energy selection with lowest recommended tool power level.
- Correct according requirement from chapter quality assurance.

Quality assurance

Setting depth control

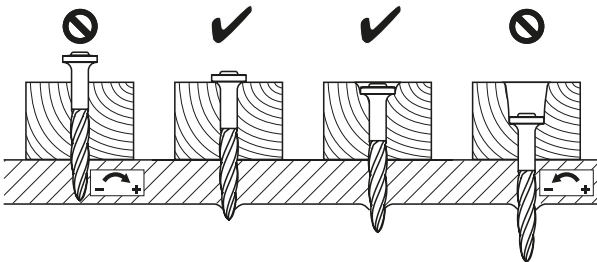

- Visible setting failures must be replaced with a new fastener, not in the same hole.
- These are abbreviated instructions which may vary by application.
- Always review / follow the instructions accompanying the product.

X-X Nail for fastening steel to concrete

Application recommendation

Fastened material properties and fastener positioning in fastened material

	Fastened material	Steel
	Fastened material thickness t_f	0.5–2 mm
	Edge distance $c_{1,min}$	20 mm
	Fastener spacing $s_{1,min}$	100 mm

Base material properties and fastener positioning in base material

	Base material	Concrete
	Base material thickness h_{min}	80 mm
	Edge distance $c_{1,min}, c_{2,min}$	70 mm
	Fastener spacing $s_{1,min}, s_{2,min}$	100 mm

- For more details in relation to base material properties, please refer to the chapter **Fastener selection guide** in the Direct Fastening Technology Manual (DFTM).

Fastener shank length recommendation

	For standard fastening:	$L_s = h_{ET} + t_f$
--	-------------------------	----------------------

Performance data

Recommended resistance under tension and shear load

Embedment depth h_{ET}	Tension load N_{rec}		Shear load V_{rec}	
	Soft/medium concrete	Tough concrete	Soft/medium concrete	Tough concrete
≥ 18 mm	0.30 kN	0.15 kN	0.50 kN	0.25 kN
≥ 20 mm	0.40 kN	0.20 kN	0.75 kN	0.40 kN
≥ 25 mm	0.50 kN	0.25 kN	1.00 kN	0.50 kN

- Redundancy of fastening points is required.
- Minimum number of fastening points for safety relevant fastenings: ≥ 5 .

Stick rate estimation

	Designation	Soft/medium concrete	Tough concrete
	X-X	95–99 %	90–95 %

- The stick rate indicates the percentage of nails that were driven correctly to carry a load.
- Stick rate can vary from the above values depending on job site conditions.

System recommendation

- For more details, please refer to the chapter **Accessories and consumables compatibility** in the Direct Fastening Technology Manual (DFTM).

System recommendation for fastening collated nails with powder-actuated tool

Designation	Powder-actuated tool				Base material		
	DX 6 MX	DX 5 MX	DX 460 MX	DX 351 MX	Soft concrete	Medium concrete	Tough concrete
X-X 22 MX to X-X 34 MX	■	■	□	□	■	■	■

■ = recommended □ = feasible

System recommendation for fastening single nails with powder-actuated tool

Designation	Powder-actuated tool					Base material		
	DX 6 F8	DX 5 F8	DX 460 MX F8	DX 351 F8	DX 2	Soft concrete	Medium concrete	Tough concrete
X-X 22 P8 to X-X 34 P8	■	■	□			■	■	■
X-X 22 P8 to X-X 34 P8				□	■	■	■	□

■ = recommended □ = feasible

Cartridge recommendation

Base material	Cartridge color (tool power level)	
	Tool type: DX 6 MX DX 6 F8 Cartridge type: 6.8/11 M	Tool type: DX 5 MX, DX 460 MX, DX 351 MX ¹⁾ DX 5 F8, DX 460 F8, DX 2 ¹⁾ , DX 351 F8 ¹⁾ Cartridge type: 6.8/11 M
Soft/medium concrete	titanium ■ (2-8)	yellow ■, red ■
Tough concrete	titanium ■ (4-8), black ■ (7-8)	red ■, black ■

¹⁾ Black cartridges do not apply for this tool.



- Tool power level adjustment by setting tests on site.
- Start tool energy selection with lowest recommended tool power level.
- Correct according requirement from chapter quality assurance.

Quality assurance

Setting depth control and power tool adjustment

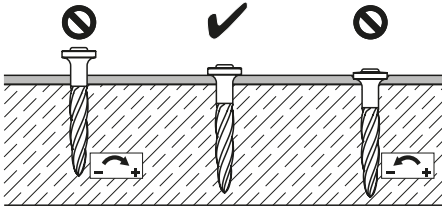

- Visible setting failures must be replaced with a new fastener, not in the same hole.
- These are abbreviated instructions which may vary by application.
- Always review / follow the instructions accompanying the product.

X-U Nail for fastening to concrete and steel

Product data

Dimensions

X-U __MX

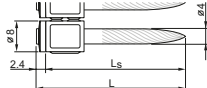

X-U __ P8

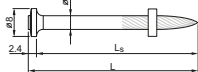

X-U __ P8 S36

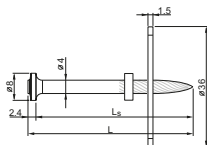

X-U __ P8 S15

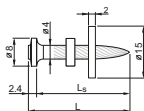

X-U 15 P8TH

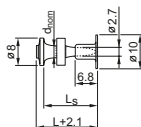

X-U __ S12

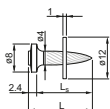

Material specifications

Carbon steel shank: HRC 58
HRC 59 (X-U 15)
Zinc coating: 5–20 µm

Recommended fastening tools

i • See fastener program in the next pages.

Approvals

ICC ESR-2269 (USA)
DIBt Z-14.4-517 (Germany), DNV-GL
ABS, LR 97/00077, IBMB 4927/2020

i Not all information presented in this product data sheet might be subject to approval / certificate content. Please refer to approval/certificate for further information.

Applications

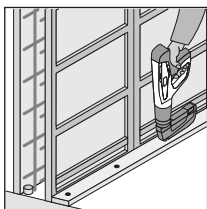

System formwork

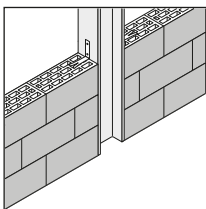

Wall-tie to steel and concrete

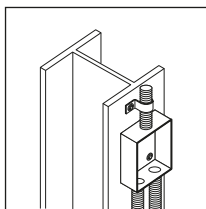

Mechanical and electrical fixtures

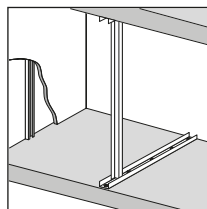

Drywall track to concrete and steel

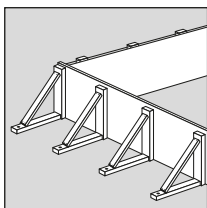

Conventional formwork

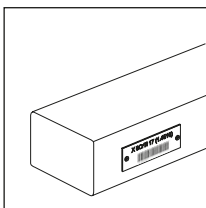

Tagging labels

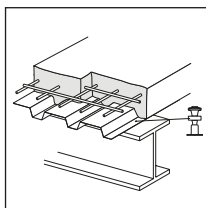

Tacking of metal decks

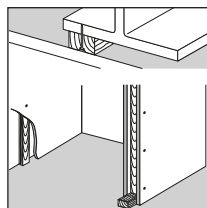

Sill plates / 2x4 wood to concrete and steel

The intended use for safety relevant and permanent applications only comprises fastenings which are not directly exposed to external weather conditions or moist atmospheres.

X-U Nail for fastening to concrete

Application recommendation

Base material thickness and fastener positioning in base material

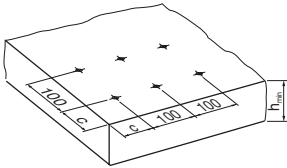

Base material thickness: $h_{\min} = 80 \text{ mm}$
 Edge distance: $c \geq 70 \text{ mm}$
 Spacing: $s \geq 100 \text{ mm}$

Fastener shank length recommendation

	Fastening type	Fastener shank length	Penetration depth
	Wood to concrete	$L_s = h_{ET} + t_i$ $t_i = 15\text{--}57 \text{ mm}$	$h_{ET} \geq 14 \text{ mm}$
	Wood to concrete, head flush with surface	$L_s = h_{ET} + t_i - 3 \text{ mm}$ $t_i = 15\text{--}57 \text{ mm}$	$h_{ET} \geq 14 \text{ mm}$
	Insulation to concrete	$L_s = h_{ET} + t_i$	$h_{ET} \geq 14 \text{ mm}$

	Fastening type	Fastener shank length	Penetration depth
	Insulation to concrete	$L_s = h_{ET} + t_i - 5 \text{ mm}$	$h_{ET} \geq 14 \text{ mm}$
	Steel to concrete	$L_s = h_{ET} + t_i$	$h_{ET} \geq 22 \text{ mm}$

Performance data

Recommended resistance under tension and shear load

Embedment depth h_{ET}	Tension load N_{rec}		Shear load V_{rec}	
	Soft/medium concrete	Tough concrete	Soft/medium concrete	Tough concrete
$\geq 14 \text{ mm}$	0.1 kN	–	0.1 kN	–
$\geq 18 \text{ mm}$	0.2 kN	–	0.2 kN	–
$\geq 22 \text{ mm}$	0.3 kN	–	0.3 kN	–
$\geq 27 \text{ mm}$	0.4 kN	–	0.4 kN	–



- For safety relevant fastenings sufficient redundancy of the entire system is required: Minimum 5 fastenings per fastened unit.
- All visible failures must be replaced.
- Valid for concrete with strength of $f_{CC} \leq 45 \text{ N/mm}^2$.
- Valid for predominantly static loading.
- Failure of the fastened material is not considered in recommended loads.
- To limit penetration of nail and to increase pull-over load, use nails with washers.
- For more details in relation to base material properties, please refer to the chapter **Fastener selection guide** in the Direct Fastening Manual (DFTM).

System recommendation

- For more details, please refer to the chapter **Accessories and consumables compatibility** in the Direct Fastening Technology Manual (DFTM).

Cartridge recommendation for fastening wood to concrete

Base material	Cartridge color (tool power level)	
	Tool type: DX 6 MX DX 6 F8 Cartridge type: 6.8/11 M	Tool type: DX 5 MX, DX 460 MX DX 5 F8, DX 460 F8, DX 2 Cartridge type: 6.8/11 M
Soft concrete/medium	titanium ■ (1-5)	green ■, yellow ■
Tough concrete	titanium ■ (4-8)	yellow ■, red ■

Cartridge recommendation for fastening steel to concrete

Base material	Cartridge color (tool power level)	
	Tool type: DX 6 MX DX 6 F8 Cartridge type: 6.8/11 M	Tool type: DX 5 MX, DX 460 MX, DX 351 MX DX 5 F8, DX 460 F8, DX 2, DX 351 F8 Cartridge type: 6.8/11 M
Soft/medium concrete	titanium ■ (1-5)	green ■, yellow ■
Tough concrete	titanium ■ (4-8)	yellow ■, red ■

- Tool power level adjustment by setting tests on site.
- Start tool energy selection with lowest recommended tool power level.
- Correct according requirement from chapter quality assurance.

X-U Nail for fastening steel to steel

Application recommendation

Fastener shank length recommendation

	Fastening type	Fastener shank length	Penetration depth
	Steel to steel	$L_s = h_{ET} + t_l$ not pre-drilled: $t_l \leq 3 \text{ mm}$	$h_{ET} = 12 \pm 2 \text{ mm}$
		pre-drilled: $3 \text{ mm} < t_l \leq 6 \text{ mm}$	

Condition for fastened material thickness: $3 \text{ mm} < t_l \leq 6 \text{ mm}$

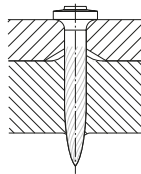
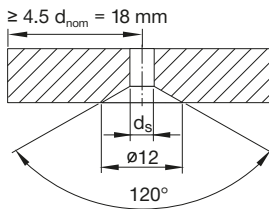

If a gap between the fastened part and the base material is unacceptable, the fastened part needs to be prepared with drilled holes.

Base material properties and fastener positioning in base material

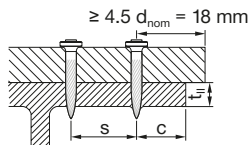

Base material thickness: $t_{II} \geq 6.0 \text{ mm}$
 Edge distance: $c \geq 15 \text{ mm}$
 Spacing: $s \geq 20 \text{ mm}$
 Type: Rolled shapes

Application limitation

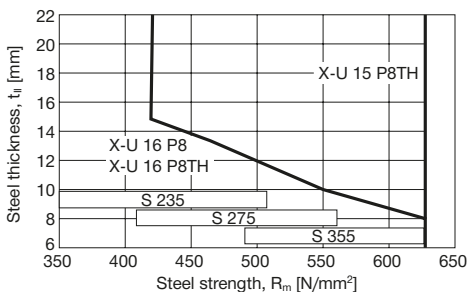

- Steel sheeting with $0.75 \text{ mm} \leq t_l \leq 1.25 \text{ mm}$
- On higher steel grades, fastening with single nails (P8 or P8TH) may yield better results (e.g. less shear breaks) than fastening with collated nails (MX or MXSP) due to better nail guidance.

Performance data

Recommended resistance under tension and shear load

Fastening of steel sheets and other steel parts with X-U 16 and X-U 19

t_f	X-U _ P8/MX N_{rec}	X-U _ S12 N_{rec}	V_{rec}
0.75 mm	1.0 kN	1.4 kN	1.2 kN
1.00 mm	1.2 kN	1.8 kN	1.8 kN
1.25 mm	1.5 kN	2.2 kN	2.6 kN
≥ 2.00 mm	2.0 kN	2.2 kN	2.6 kN

Tacking of steel sheets with X-U 15

according to ECCS-recommendation N73, „Good Construction Practice for Composite Slabs”

t_f	N_{rec}	V_{rec}
0.75–1.25 mm	0.6 kN	0.8kN

Conditions

- Valid for steel sheet with minimum tensile strength ≥ 360 N/mm².
- For intermediate sheet thicknesses, use recommended load for next smaller thickness.
- In case of a design based on the characteristic resistance, recommended values have to be multiplied by two: $N_{Rk} = N_{rec} \cdot 2.0$, $V_{Rk} = V_{rec} \cdot 2.0$
- For X-U 16 S12:
 - Base material thickness $t_{l,min} = 8$ mm for $t_f \geq 1.50$ mm
 - Base material thickness $t_{l,min} = 6$ mm for $t_f \leq 1.25$ mm
- Other fastened parts: clips, brackets, etc.
- Redundancy (multiple fastening) must be provided.
- Valid for predominantly static loading

Forces of constraint

When fastening large pieces of steel, the possibility of shear loadings from forces of constraint should be considered. Avoid exceeding V_{rec} for the fastener shank!

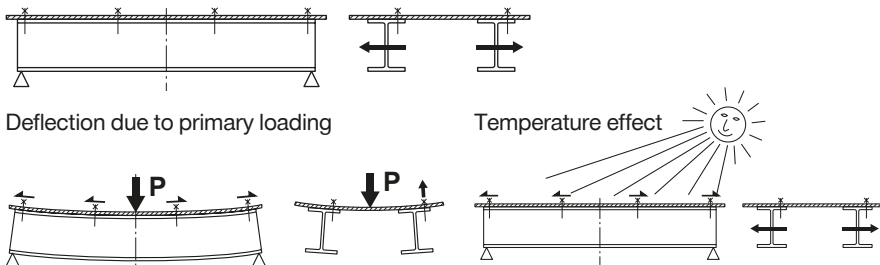

System recommendation

- For more details, please refer to the chapter **Accessories and consumables compatibility** in the Direct Fastening Technology Manual (DFTM).

Cartridge recommendation for X-U 16 P8, X-U 16 P8 TH, X-U 16 MX

Base material		Cartridge color (tool power level)	
		Tool type: DX 6 MX	Tool type: DX 5 MX, DX 460 MX, DX 351 MX ¹⁾
		DX 6 F8	DX 5 F8, DX 460 F8, DX 351 F8 ¹⁾ , DX 2 ¹⁾
		Cartridge type: 6.8/11 M	Cartridge type: 6.8/11 M
S235 to S275	$6 \leq t_{II} < 10$ mm	titanium ■ (4-8)	red ■
	$10 \leq t_{II} \leq 20$ mm	titanium ■ (6-8), black ■ (7-8)	red ■, black ■
S355	$6 \leq t_{II} \leq 8$ mm	titanium ■ (6-8), black ■ (7-8)	red ■, black ■

¹⁾ Black cartridges do not apply for this tool.

Cartridge recommendation for X-U 15 P8TH

Base material		Cartridge color (tool power level)	
		Tool type: DX 6 F8	Tool type: DX 5 F8, DX 460 F8, DX 351 F8 ¹⁾
		Cartridge type: 6.8/11 M	Cartridge type: 6.8/11 M
		S235 to	$6 \leq t_{II} < 12$ mm
S355	$12 \leq t_{II} \leq 20$ mm	titanium ■ (4-8)	red ■

- Tool power level adjustment by setting tests on site.
- Start tool energy selection with lowest recommended tool power level.
- Correct according requirement from chapter quality assurance.

Quality assurance

Setting depth control

X-U __ P8/MX

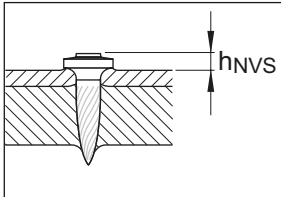
 $h_{NVS} = 2.5-4.5 \text{ mm}$

X-U __ S12

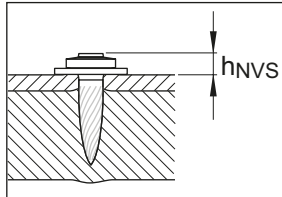
 $h_{NVS} = 4.0-5.5 \text{ mm}$

X-U _ P8TH / MXSP

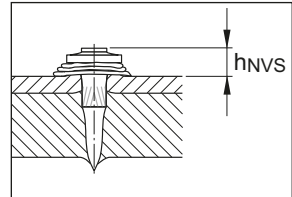
 $h_{NVS} = 4.0-6.0 \text{ mm}$

X-U Nail for fastening wood to steel

Application recommendation

Base material properties

Base material thickness: $t_{ij} \geq 4.0$ mm

Fastener shank length recommendation

	Fastening type	Fastener shank length	Penetration depth
	Wood to steel	$L_s = h_{ET} + t_i$ $t_i = 15-57$ mm	$h_{ET} \geq 8$ mm
	Wood to steel, head flush with surface	$L_s = h_{ET} + t_i - 3$ mm $t_i = 15-57$ mm	$h_{ET} \geq 8$ mm

Application limitation

For X-U 22 P8 to X-U 62 P8

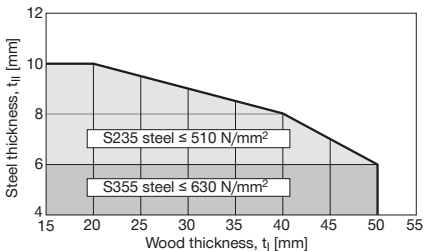

- On higher steel grades, fastening with single nails may yield better results (e.g. less shear breaks) than fastening with collated nails due to better nail guidance.

Performance data

Recommended resistance under tension and shear load

Designation	Tension load N_{rec}		Shear load V_{rec}	
X-U	0.3 kN		0.60 kN	

Conditions:

- For safety-relevant fastenings sufficient redundancy of the entire system is required.
- In case soft material is fastened, its strength determines the loads.
- To limit penetration of nail and to increase pull-over load, use nails with washers.
- Observance of edge distance and fastener spacing in compliance with recognized standards EN 1995 (see approval).
- With respect to details of fastening wood, chipboard or OSB members to steel base material, it is referred to the German approval DIBt Z-14.4-517.

System recommendation

- For more details, please refer to the chapter **Accessories and consumables compatibility** in the Direct Fastening Technology Manual (DFTM).

Cartridge recommendation for X-U 22 P8 to X-U 62 P8

Base material		Cartridge color (tool power level)	
		Tool type: DX 6 MX DX 6 F8	Tool type: DX 5 MX, DX 460 MX DX 5 F8, DX 460 F8, DX 2 ¹⁾
		Cartridge type: 6.8/11 M	Cartridge type: 6.8/11 M
S235 to S355	$4 \leq t_{II} < 6 \text{ mm}$	titanium ■ (1-5)	green ■, yellow ■
	$6 \leq t_{II} \leq 10 \text{ mm}$	titanium ■ (4-8), black ■ (7-8)	yellow ■, red ■, black ■

¹⁾ Black cartridges do not apply for this tool.

- Tool power level adjustment by setting tests on site.
- Start tool energy selection with lowest recommended tool power level.
- Correct according requirement from chapter quality assurance.

Fastener program

Fastener	Item no.	L _s	Powder-actuated tools					Description
			DX 6 MX, DX 5 MX, DX 460 MX	DX 6 F8, DX 5 F8 DX 460 F8	DX 2	DX 351 MX	DX 351 F8	
X-U 16 MX	237344	16 mm	■			■		Sheet metal on steel
X-U 19 MX	237345	19 mm	■			■		Sheet metal on steel
X-U 22 MX	237346	22 mm	■			■		Wood on concrete/steel
X-U 27 MX	237347	27 mm	■			■		Wood on concrete/steel
X-U 32 MX	237348	32 mm	■					Wood on concrete/steel
X-U 37 MX	237349	37 mm	■					Wood on concrete/steel
X-U 42 MX	237350	42 mm	■					Wood on concrete/steel
X-U 47 MX	237351	47 mm	■					Wood on concrete/steel
X-U 52 MX	237352	52 mm	■					Wood on concrete/steel
X-U 57 MX	237353	57 mm	■					Wood on concrete/steel
X-U 62 MX	237354	62 mm	■					Wood on concrete/steel
X-U 72 MX	237356	72 mm	■					Wood on concrete/steel
X-U 16 P8	237330	16 mm		■	■		■	Sheet metal on steel
X-U 19 P8	237331	19 mm		■	■		■	Sheet metal on steel
X-U 22 P8	237332	22 mm		■	■		■	Wood on concrete/steel
X-U 27 P8	237333	27 mm		■	■		□	Wood on concrete/steel
X-U 32 P8	237334	32 mm		■	■		□	Wood on concrete/steel
X-U 37 P8	237335	37 mm		■	■		□	Wood on concrete/steel
X-U 42 P8	237336	42 mm		■	■		□	Wood on concrete/steel
X-U 47 P8	237337	47 mm		■	■		□	Wood on concrete/steel
X-U 52 P8	237338	52 mm		■	■			Wood on concrete/steel
X-U 57 P8	237339	57 mm		■	■			Wood on concrete/steel
X-U 62 P8	237340	62 mm		■	■			Wood on concrete/steel
X-U 72 P8	237342	72 mm		■	■			Wood on concrete/steel
X-U 16 P8TH	237329	16 mm		■	■		■	Sheet metal on steel, *)
X-U 19 P8TH	385781	19 mm		■	■		■	Sheet metal on steel, *)
X-U 27 P8TH	385782	27 mm		■	■		□	Sheet metal on concrete, *)
X-U 15 MXSP	383466	16 mm	■			□		Sheet metal on steel
X-U 15 P8TH	237328	16 mm		■	□		□	Sheet metal on steel
X-U 27 P8S15	237371	27mm		■	■		□	High pull-over strength
X-U 32 P8S15	237372	32 mm		■	■		□	High pull-over strength

Fastener	Item no.	L _S	Powder-actuated tools					Description
			DX 6 MX, DX 5 MX, DX 460 MX	DX 6 F8, DX 5 F8, DX 460 F8	DX 2	DX 351 MX	DX 351 F8	
X-U 32 P8S36	237374	32 mm		■	■		<input type="checkbox"/>	Soft material on concr./steel
X-U 52 P8S36	237376	52 mm		■	■		<input type="checkbox"/>	Soft material on concr./steel
X-U 72 P8S36	237379	72 mm		■	■			Soft material on concr./steel

■ = recommended, □ = feasible

*) firm hold down

Fastener	Item no.	L _S	Powder-actuated tools					Description
			DX 460 F8S12	DX 5 F8S12	DX 462 F8S12			
X-U 16 S12	237357	16 mm	■	■	■			High pull-over strength
X-U 19 S12	237358	19 mm	■	■	■			High pull-over strength
X-U 22 S12	237359	22 mm	■	■	■			High pull-over strength
X-U 27 S12	237360	27 mm	■	■	■			High pull-over strength
X-U 32 S12	237361	32 mm	■	■	■			High pull-over strength

■ = recommended, □ = feasible

*) firm hold down

X-P Nail for fastening to concrete and steel

Product data

Product description

X-P MX



- Designed for fastening on tough concrete and steel.
- Long conical nail tip designed for best drivability in tough concrete.
- High hardness for best penetration in tough concrete.
- High load performance on tough concrete.

X-P P8



Dimensions for nails

Technical drawing	Designation	Shank length L_s	Head length L_h	Shank diameter d_s	Head diameter d_h
	X-P 22	22 mm	2.4 mm	4 mm	8.2 mm
	X-P 27	27 mm			
	X-P 34	34 mm			
	X-P 40	40 mm			
	X-P 47	47 mm			
	X-P 52	52 mm			
	X-P 57	57 mm			
	X-P 62	62 mm			
	X-P 72	72 mm			

Material specification and material properties for nails

Designation	Element	Material	Coating	Minimum coating thickness	Hardness
X-P	Nail	Carbon steel	Zinc	5 μm	59 HRC

Applications

Fastening wood to concrete

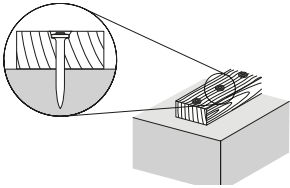

Fastening wood to steel

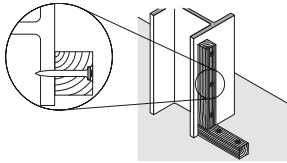

Fastening steel to concrete

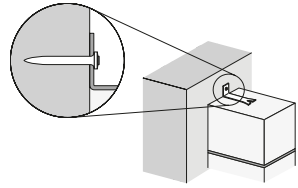

Base materials

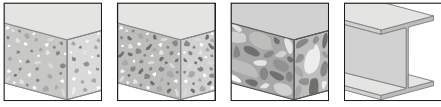

Soft concrete Medium concrete Tough concrete Steel

Load conditions



Static/
quasi static

Environmental conditions



Dry indoor

• For more details, please refer to following technical document: Hilti Corrosion Handbook.

Approvals/certificates

Authority	Approval/certificate no.	Date of issue	Country of issue
IBMB	19210-2017	11/2017	Germany
IBMB	19211-2017	11/2017	Germany
IBMB	19212-2017	11/2017	Germany
IBMB	4927/2020	11/2019	Germany
ICC-ES ESR	2269	02/2019	USA
Rom. Ministry ICECCON	AT 016-01/420-2020	03/2020	Romania
VHT	PZ-809-15-Hilti-171027	10/2017	Germany



- Not all information presented in this product data sheet might be subject to approval/certificate content. Please refer to approval/certificate for further information.

Fastener program

Item no. and description

Designation	Item no.	Description
X-P 22 MX	2150380	Collated nail
X-P 27 MX	2150381	
X-P 34 MX	2150382	
X-P 40 MX	2150383	
X-P 47 MX	2173900	
X-P 52 MX	2173901	
X-P 57 MX	2173902	
X-P 62 MX	2173903	
X-P 72 MX	2173904	
X-P 22 P8	2150366	
X-P 27 P8	2150367	
X-P 34 P8	2150368	
X-P 40 P8	2150369	
X-P 47 P8	2173875	
X-P 52 P8	2173876	
X-P 57 P8	2173877	
X-P 62 P8	2173878	
X-P 72 P8	2173879	

X-P Nail for fastening wood to concrete

Application recommendation

Fastened material properties and fastener positioning in fastened material

	Fastened material	Wood
	Fastened material thickness t_f	15–50 mm (soft/medium concrete)
	Fastened material thickness t_f	15–40 mm (tough concrete)
	Edge distance $c_{1,min}$	250 mm
	Edge distance $c_{2,min}$	20 mm
Fastener spacing $s_{1,min}$	500 mm	

- Edge distances and fastener spacing are recommendations to avoid splitting.

Base material properties and fastener positioning in base material

	Base material	Concrete
	Base material thickness h_{min}	80 mm
	Edge distance $c_{1,min}$, $c_{2,min}$	70 mm
	Fastener spacing $s_{1,min}$, $s_{2,min}$	100 mm

Fastener shank length recommendation

	For standard fastening:	$L_s = h_{ET} + t_i$
	For flush fastening:	$L_s = h_{ET} + t_i - 3 \text{ mm}$

Performance data

Recommended resistance under tension and shear load

Embedment depth h_{ET}	Tension load N_{rec}		Shear load V_{rec}	
	Soft/medium concrete	Tough concrete	Soft/medium concrete	Tough concrete
≥ 14 mm	0.10	–	0.10	–
≥ 18 mm	0.20	–	0.20	–
≥ 20 mm	0.30	–	0.30	–
≥ 25 mm	0.40	0.10 kN	0.40	0.10 kN

- Redundancy of fastening points is required.
- Minimum number of fastening points for safety relevant fastenings: ≥ 5 .
- For more details in relation to base material properties, please refer to the chapter **Fastener selection guide** in the Direct Fastening Technology Manual (DFTM).

Stick rate estimation

	Designation	Soft/medium concrete	Tough concrete
	X-P	84–92 %	80–90 %

- The stick rate indicates the percentage of nails that were driven correctly to carry a load.
- Stick rate can vary from the above values depending on job site conditions.

System recommendation



- For more details, please refer to the chapter **Accessories and consumables compatibility** in the Direct Fastening Technology Manual (DFTM).

System recommendation for fastening collated nails with powder-actuated tools

Designation	Powder-actuated tool							Base material		
	DX 6 MX	DX 5 MX	DX 460 MX					Soft concrete	Medium concrete	Tough concrete
X-P 34 MX to X-P 72 MX	■	□	□					■	■	■

■ = recommended □ = feasible

System recommendation for fastening single nails with powder-actuated tools

Designation	Powder-actuated tool							Base material		
	DX 6 F8	DX 5 F8	DX 460 F8	DX 460 F8	DX351 F8	DX 2		Soft concrete	Medium concrete	Tough concrete
X-P 34 P8 to X-P 72 P8	■	□	□	□				■	■	■
X-P 34 P8 to X-P 47 P8					□			■	■	□
X-P 34 P8 to X-P 62 P8						■		■	■	□

■ = recommended □ = feasible

Cartridge recommendation

Base material	Cartridge color (tool power level)	
	Tool type: DX 6 MX DX 6 F8	Tool type: DX 5 MX, DX 460 MX DX 5 F8, DX 460 F8, DX 351 F8 ¹⁾ , DX 2 ¹⁾
	Cartridge type: 6.8/11 M	Cartridge type: 6.8/11 M
Soft/medium concrete	titanium ■ (1-8)	green ■, yellow ■, red ■
Tough concrete	titanium ■ (4-8), black ■ (6-8)	red ■, black ■

¹⁾ Black cartridges do not apply for this tool.



- Tool power level adjustment by setting tests on site.
- Start tool energy selection with lowest recommended tool power level.
- Correct according requirement from chapter quality assurance.

Quality assurance

Setting depth control and power tool adjustment

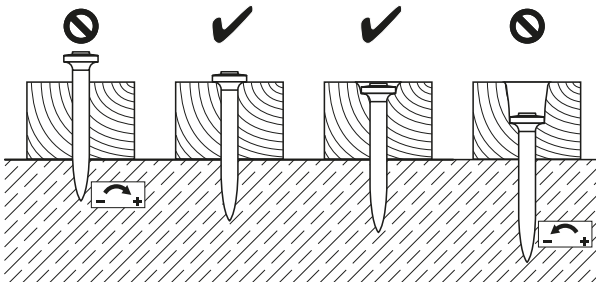

- Visible setting failures must be replaced with a new fastener, not in the same hole.
- These are abbreviated instructions which may vary by application.
- Always review/follow the instructions accompanying the product.

X-P Nail for fastening wood to steel

Application recommendation

Fastened material properties and fastener positioning in fastened material

	Fastened material	Wood
	Fastened material thickness t_f	15–50 mm
	Edge distance $c_{1,min}$	250 mm
	Edge distance $c_{2,min}$	20 mm
	Fastener spacing $s_{1,min}$	500 mm

- Edge distances and fastener spacing are recommendations to avoid splitting.

Base material properties and fastener positioning in base material

	Base material	Steel
	Base material thickness t_{II}	4–10 mm
	Edge distance $c_{1,min}$	15 mm
	Fastener spacing $s_{1,min}$	20 mm

Fastener shank length recommendation

	For standard fastening:	$L_s = t_I + t_{II} + 6 \text{ mm}$
	For flush fastening:	$L_s = t_I + t_{II} + 3 \text{ mm}$
	Penetration of nail point through base material:	$p_p \geq 6 \text{ mm}$

Application limitation for fastening on steel

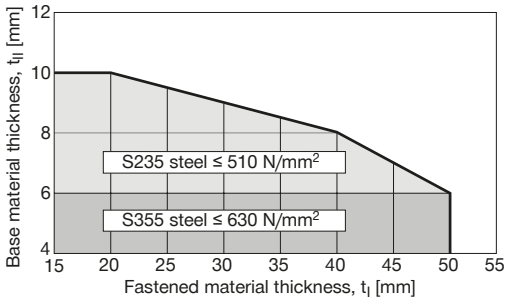

- For X-P 22 P8 to X-P 62 P8
- On higher steel grades, fastening with single nails (P8) may yield better results (e.g. less shear breaks) than fastening with collated nails (MX) due to better nail guidance.

Performance data

Recommended resistance under tension and shear load

Designation	Tension load N_{rec}		Shear load V_{rec}	
X-P	0.40 kN		0.60 kN	

System recommendation

- For more details, please refer to the chapter **Accessories and consumables compatibility** in the Direct Fastening Technology Manual (DFTM).

System recommendation for fastening collated nails with powder-actuated tools

Designation	Powder-actuated tool						Base material		
	DX 6 MX	DX 5 MX	DX 460 MX				S235	S275	S355
X-P 34 MX to X-P 62 MX	■	□	□				■	■	■

■ = recommended □ = feasible

System recommendation for fastening single nails with powder-actuated tools

Designation	Powder-actuated tool						Base material		
	DX 6 F8	DX 5 F8	DX 460 F8	DX351 F8	DX 2		S235	S275	S355
X-P 34 P8 to X-P 62 P8	■	□	□				■	■	■
X-P 34 P8 to X-P 47 P8				□			■	■	□
X-P 34 P8 to X-P 47 P8					■		■	■	□

■ = recommended □ = feasible

Cartridge recommendation

Base material		Cartridge color (tool power level)	
		Tool type: DX 6 MX DX 6 F8	Tool type: DX 5 MX, DX 460 MX DX 5 F8, DX 460 F8, DX 351 F8 ¹⁾ , DX 2 ¹⁾
		Cartridge type: 6.8/11 M	Cartridge type: 6.8/11 M
S235 to S355	$4 \leq t_{II} < 6 \text{ mm}$	titanium ■ (1-5)	green ■, yellow ■
	$6 \leq t_{II} \leq 10 \text{ mm}$	titanium ■ (4-8), black ■ (6-8)	red ■, black ■

¹⁾ Black cartridges do not apply for this tool.



- Tool power level adjustment by setting tests on site.
- Start tool energy selection with lowest recommended tool power level.
- Correct according requirement from chapter quality assurance.

Quality assurance

Setting depth control

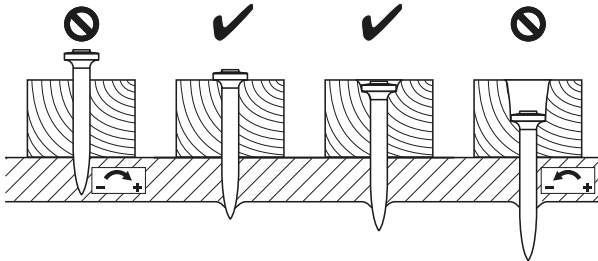

- Visible setting failures must be replaced with a new fastener, not in the same hole.
- These are abbreviated instructions which may vary by application.
- Always review/follow the instructions accompanying the product.

X-P Nail for fastening steel to concrete

Application recommendation

Fastened material properties and fastener positioning in fastened material

	Fastened material	Steel
	Fastened material thickness t_f	0.6–2 mm
	Edge distance $c_{1,min}$, $c_{2,min}$	20 mm
	Fastener spacing $s_{1,min}$, $s_{2,min}$	100 mm

Base material properties and fastener positioning in base material

	Base material	Concrete
	Base material thickness h_{min}	80 mm
	Edge distance $c_{1,min}$, $c_{2,min}$	70 mm
	Fastener spacing $s_{1,min}$, $s_{2,min}$	100 mm

Fastener shank length recommendation

	For standard fastening:	$L_s = h_{ET} + t_f$

Performance data

Recommended resistance under tension and shear load

Embedment depth h_{ET}	Tension load N_{rec}		Shear load V_{rec}	
	Soft/medium concrete	Tough concrete	Soft/medium concrete	Tough concrete
≥ 18 mm	0.20 kN	0.10 kN	0.40 kN	0.20 kN
≥ 20 mm	0.30 kN	0.15 kN	0.50 kN	0.30 kN
≥ 25 mm	0.40 kN	0.20 kN	0.80 kN	0.40 kN

- Redundancy of fastening points is required.
- Minimum number of fastening points for safety relevant fastenings: ≥ 5 .
- For more details in relation to base material properties, please refer to the chapter **Fastener selection guide** in the Direct Fastening Technology Manual (DFTM).

Stick rate estimation

	Designation	Soft/medium concrete	Tough concrete
		X-P	84–92 %

- The stick rate indicates the percentage of nails that were driven correctly to carry a load.
- Stick rate can vary from the above values depending on job site conditions.

System recommendation



- For more details, please refer to the chapter **Accessories and consumables compatibility** in the Direct Fastening Technology Manual (DFTM).

System recommendation for fastening collated nails with powder-actuated tools

Designation	Powder-actuated tool							Base material		
	DX 6 MX	DX 5 MX	DX 460 MX	DX 351 MX				Soft concrete	Medium concrete	Tough concrete
X-P 22 MX to X-P 34 MX	■	□	□	□				■	■	■

■ = recommended □ = feasible

System recommendation for fastening single nails with powder-actuated tools

Designation	Powder-actuated tool						Base material			
	DX 6 F8	DX 5 F8	DX 460 F8	DX351 F8	DX 2			Soft concrete	Medium concrete	Tough concrete
X-P 22 P8 to X-P 34 P8	■	□	□	□				■	■	■
X-P 22 P8 to X-P 34 P8					■			■	■	□

■ = recommended □ = feasible

Cartridge recommendation

Base material		Cartridge color (tool power level)	
		Tool type: DX 6 MX	Tool type: DX 5 MX, DX 460 MX DX 351 MX ¹⁾
		DX 6 F8	DX 5 F8, DX 460 F8, DX 351 F8 ¹⁾ , DX 2 ¹⁾
		Cartridge type: 6.8/11 M	Cartridge type: 6.8/11 M
S235 to S355	$4 \leq t_{ll} < 6 \text{ mm}$	titanium ■ (1-5)	green ■, yellow ■
	$6 \leq t_{ll} \leq 10 \text{ mm}$	titanium ■ (4-8), black ■ (6-8)	red ■, black ■
Soft/medium concrete		titanium ■ (1-8)	green ■, yellow ■, red ■
Tough concrete		titanium ■ (4-8), black ■ (6-8)	red ■, black ■

¹⁾ Black cartridges do not apply for this tool.

- Tool power level adjustment by setting tests on site.
- Start tool energy selection with lowest recommended tool power level.
- Correct according requirement from chapter quality assurance.

Quality assurance

Setting depth control and power tool adjustment

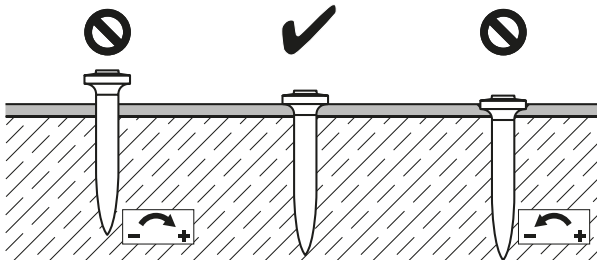

- Visible setting failures must be replaced with a new fastener, not in the same hole.
- These are abbreviated instructions which may vary by application.
- Always review/follow the instructions accompanying the product.

X-C Nail – Fastening to concrete and sand lime masonry

Product data

Dimensions

X-C __ P8

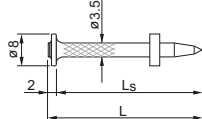

X-C __ MX

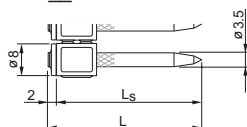

X-C __ P8S23

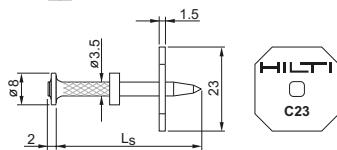

X-C __ P8S36

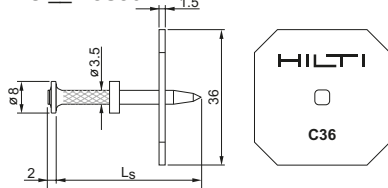

Material specifications

Carbon steel shank: HRC 56.5
HRC 58 *)

Zinc coating: 5–20 μm

*) X-C 82, 97 and 117 P8 ($d_{\text{nom}} = 3.7 \text{ mm}$)

Recommended fastening tools

- See fastener program in the next pages.

X-C __ P8S23T (for tunneling applications)

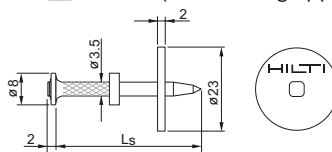

Applications

Examples

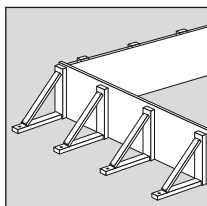

Conventional formwork

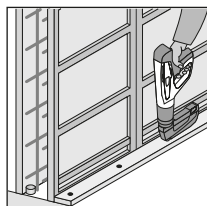

System formwork

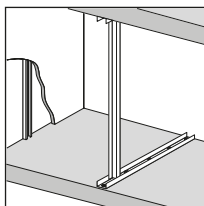

Drywall track to concrete

Performance data

Recommended resistance under tension and shear load

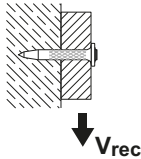
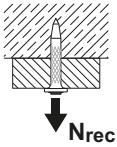

Fastening wood to concrete:

N_{rec}	V_{rec}	h_{ET}
0.4 kN	0.4 kN	≥ 27 mm
0.3 kN	0.3 kN	≥ 22 mm
0.2 kN	0.2 kN	≥ 18 mm
0.1 kN	0.1 kN	≥ 14 mm

Fastenings to sandlime masonry:

$$N_{rec} = V_{rec} = 0.4 \text{ kN for } h_{ET} \geq 27 \text{ mm}$$

Conditions:

- For safety relevant fastenings sufficient redundancy of the entire system is required: minimum 5 fastenings per fastened unit.
- All visible failures must be replaced.
- Valid for concrete with strength of $f_{cc} < 45 \text{ N/mm}^2$.
- Valid for predominantly static loading.
- Failure of the fastened material is not considered in recommended loads.
- To limit penetration of nail in soft material and to increase pullover load, use nails with washers.
- For more details in relation to base material properties, please refer to the chapter **Fastener selection guide** in the Direct Fastening Manual (DFTM).

Application recommendation

Base material and fastened material thickness

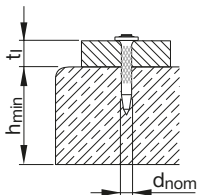

Concrete
 $h_{min} = 80 \text{ mm}$
 $t_1 \leq 50.0 \text{ mm}$

Fastener positioning in base material

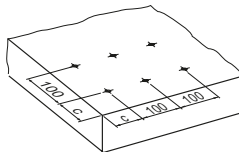

Edge distance: $c \geq 70 \text{ mm}$
 Spacing: $s \geq 100 \text{ mm}$

Fastener shank length recommendation

For standard fastening: $L_S = h_{ET} + t_i$ [mm]

For flush fastening: $L_S = h_{ET} + t_i - 5$ [mm]

Concrete: $h_{ET} = 22$ mm

Sandlime masonry: $h_{ET} = 27$ mm

Fastening
wood to concrete
 $t_i = 15 - 40$ mm

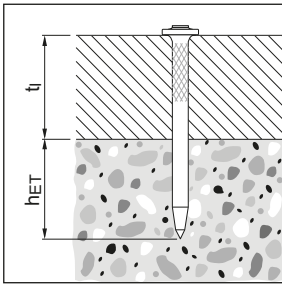

Fastening
insulation to concrete
 $t_i = 15 - 40$ mm

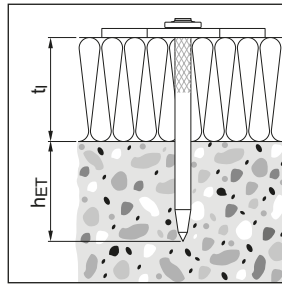

Fastening
steel to concrete
 $t_i = 0.6 - 2$ mm

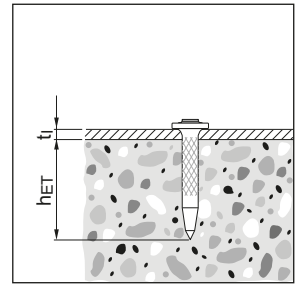

Corrosion information



- The intended use for safety relevant and permanent applications only comprises fastenings which are not directly exposed to external weather conditions or moist atmospheres.
- For more details, please refer to following technical document: Hilti Corrosion Handbook.

System recommendation

- For more details, please refer to the chapter **Accessories and consumables compatibility** in the Direct Fastening Technology Manual (DFTM).

Cartridge recommendation for fastening wood to masonry and concrete

Base material	Cartridge color (tool power level)	
	Tool type: DX 6 MX DX 6 F8	Tool type: DX 5 MX, DX 460 MX DX 5 F8, DX 460 F8, DX 2
	Cartridge type: 6.8/11 M	Cartridge type: 6.8/11 M
Sand lime masonry	titanium ■ (1-3)	green ■
Soft/medium concrete	titanium ■ (1-5)	green ■, yellow ■
Tough concrete	titanium ■ (4-8)	yellow ■, red ■

Cartridge recommendation for fastening steel to masonry and concrete

Base material	Cartridge color (tool power level)	
	Tool type: DX 6 MX DX 6 F8	Tool type: DX 5 MX, DX 460 MX, DX 351 MX DX 5 F8, DX 460 F8, DX 351 F8, DX 2
	Cartridge type: 6.8/11 M	Cartridge type: 6.8/11 M
Sand lime masonry	titanium ■ (1-3)	green ■
Soft/medium concrete	titanium ■ (1-5)	green ■, yellow ■
Tough concrete	titanium ■ (4-8)	yellow ■, red ■

- Tool power level adjustment by setting tests on site.
- Start tool energy selection with lowest recommended tool power level.

Fastener program

Nails					Tools							Description
Designation	Item no.		Specification		DX 6 MX, DX 5 MX, DX 460 MX	DX 6 F8, DX 5 F8, DX 460 F8	DX 2, DX 36	DX E72	DX 351 MX	DX 351 F8	DX 35	
	Packs of 1000 pcs	Packs of 100 pcs	L _s (mm)	d _{nom} (mm)								
X-C 22 P8	2091378	2091377	22	3.5	■	■	■		■	■	Thin metal part to concrete	
X-C 27 P8	2091380	2091379	27	3.5	■	■	■		■	■	Thin metal part to concrete	
X-C 32 P8	2091382	2091381	32	3.5	■	■	■		■	■	Thin metal part to concrete	
X-C 37 P8	2091384	2091383	37	3.5	■	■	■		■	■	Thin metal part to concrete	
X-C 42 P8	2091386	2091385	42	3.5	■	■	■		■		Soft mat / Wood on concrete	
X-C 47 P8	2091388	2091387	47	3.5	■	■	■		■	■	Soft mat / Wood on concrete	
X-C 52 P8	2091390	2091389	52	3.5	■	■	■				Wood on concrete	
X-C 62 P8	2091392	2091391	62	3.5	■	■	■				Wood on concrete	
X-C 72 P8		2091393	72	3.5	■	■	■				Wood on concrete	
X-C 82 P8		360930	82	3.7	■	■	■				Wood on concrete (with pre-hammering)	
X-C 97 P8		360931	97	3.7	■	■	■				Wood on concrete (with pre-hammering)	
X-C 117 P8		360933	117	3.7	■	■	■				Wood on concrete (with pre-hammering)	
X-C 20 THP	2091373	2091372	20	3.5	■	■	■		■	■	Thin metal part to concrete	
X-C 22 P8 S15TH		2091410	22	3.5	■	■	■				Thin metal part to concrete	
X-C 22 P8TH	2091374	2091375	22	3.5	■	■	■		■	■	Thin metal part to concrete	
X-C 27 P8TH		2091376	27	3.5	■	■	■		■	■	Thin metal part to concrete	
X-C 27 P8S23	2091396	2091395	27	3.5	■	■	■		■	■	High pull-over strength on concrete	
X-C 32 P8S23	2091399	2091397	32	3.5	■	■	■		■	■	High pull-over strength on concrete	
X-C 37 P8S23	2091401	2091400	37	3.5	■	■	■		■	■	High pull-over strength on concrete	
X-C 42 P8S23	2091404	2091403	42	3.5	■	■	■		■	■	High pull-over strength on concrete	
X-C 47 P8S23	2091406	2091405	47	3.5	■	■	■		■	■	High pull-over strength on concrete	
X-C 37 P8S36	2091407		37	3.5	■	■	■		■	■	High pull-over strength on concrete	
X-C 52 P8S36	2091408		52	3.5	■	■	■		■		High pull-over strength on concrete	
X-C 62 P8S36	2091409		62	3.5	■	■	■				High pull-over strength on concrete	
X-C 32 P8S23T	2091398		32	3.5	■	■	■				Tunneling applications	
X-C 37 P8S23T	2091402		37	3.5	■	■	■				Tunneling applications	
X-C 20 MX	2091264	2091265	20	3.5	■				■		Thin metal part to concrete	
X-C 27 MX	2091266	2091267	27	3.5	■				■		Thin metal part to concrete	
X-C 32 MX	2091268	2091269	32	3.5	■						Thin metal part to concrete	
X-C 37 MX	2091360	2091361	37	3.5	■						Thin metal part to concrete	
X-C 42 MX	2091362	2091363	42	3.5	■						Soft material / Wood on concrete	
X-C 47 MX	2091364	2091365	47	3.5	■						Soft material / Wood on concrete	
X-C 52 MX	2091366	2091367	52	3.5	■						Wood on Concrete	
X-C 62 MX	2091368	2091369	62	3.5	■						Wood on Concrete	
X-C 72 MX	2091370	2091371	72	3.5	■						Wood on Concrete	

■ recommended, ■ feasible

X-S Nail for fastening drywall track to steel

Product data

Dimensions

X-S13 THP

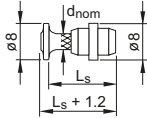

X-S16 P8TH

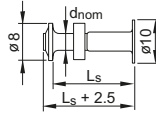

Material specifications

Carbon steel shank:

X-S 16 P8 TH HRC 55.5

X-S13 THP/MX HRC 52.5

Zinc coating: 5–13 μm

Recommended fastening tools

DX 6 MX, DX 460 MX, DX 5 MX, DX 36,

DX 2, DX 351 MX, DX-E 72

DX 6 F8, DX 460 F8, DX 5 F8, DX 351 F8,

- See fastener program in the next pages.

Approvals

ICC (USA): X-S (ESR-1752)



Not all information presented in this product data sheet might be subject to approval / certificate content. Please refer to approval/certificate for further information.

Applications

Examples

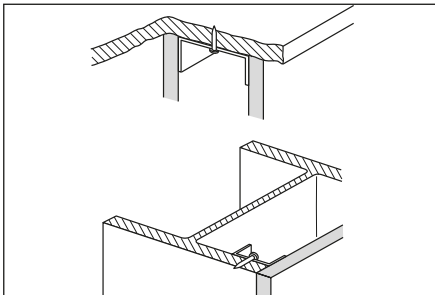

Drywall tracks to steel

Performance data

Recommended resistance under tension and shear load

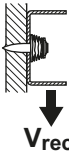
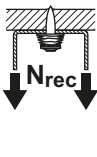

Steel 0.4 kN

Conditions:

- Redundancy (multiple fastening) must be provided
- All visible failures must be replaced

Application recommendation

Thickness of base material

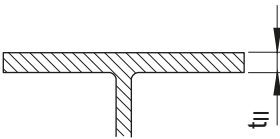

Steel: $t_{II} \geq 4 \text{ mm}$

Thickness of fastened material

Wooden track: $t_I \leq 24 \text{ mm}$

Metal track: $t_I \leq 2 \text{ mm}$

Fastener positioning

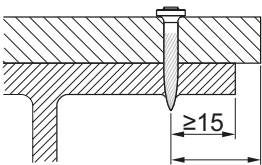

Edge distance: $c \geq 15 \text{ mm}$

$\geq 4.5 d_{nom} = 17 \text{ mm}$

Application limits

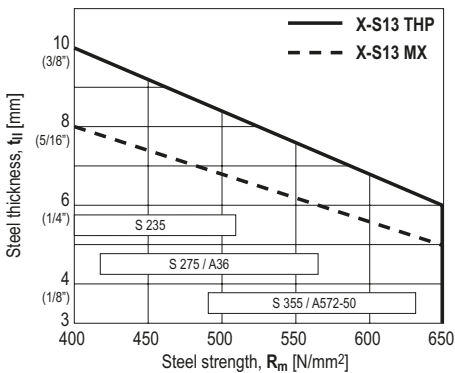

DX 351

Corrosion information

- The intended use only comprises fastenings which are not directly exposed to external weather conditions or moist atmospheres.
- For more details, please refer to following technical document: Hilti Corrosion Handbook.

System recommendation

- For more details, please refer to the chapter **Accessories and consumables compatibility** in the Direct Fastening Technology Manual (DFTM).

Fastener selection

	Application	Base material
X-S 16	Metal track	Steel
X-S 13	Metal track	Steel

increasing strength

Cartridge recommendation

Base material		Cartridge color (tool power level)	
		Tool type: DX 6 MX DX 6 F8	Tool type: DX 5 MX, DX 460 MX, DX 351 MX DX 5 F8, DX 460 F8, DX 351 F8, DX 2
		Cartridge type: 6.8/11 M	Cartridge type: 6.8/11 M
S235 to	$3 \leq t_{II} < 6 \text{ mm}$	titanium ■ (1-4)	green ■, yellow ■
S355	$6 \leq t_{II} \leq 10 \text{ mm}$	titanium ■ (3-6)	yellow ■, red ■

- Tool power level adjustment by setting tests on site.
- Start tool energy selection with lowest recommended tool power level.
- Correct according requirement from chapter quality assurance.

Quality assurance

Setting depth control

Fastening to steel

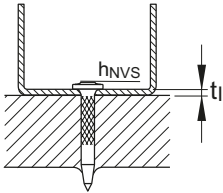

X-S: $h_{NVS} = 2-4 \text{ mm}$

Fastener program

Fastener	Item no. Packs of 1000 nails	Item no. Packs of 100 nails	L_s	d_{nom}	Standard tools							
					DX 6 MX, DX 5 MX, DX 460 MX	DX 6 F8, DX 5 F8, DX 460 F8	DX 2, DX 36	DX E72	DX 35T MX	DX 35T F8	DX 35	
X-S 13 THP	274061	274059	13 mm	3.7 mm		■	■	■		■	■	
X-S 16 P8 TH	388842		16 mm	3.7 mm		■	■	■		■	■	
X-S 13 MX	274062	274060	13 mm	3.7 mm	■				■			

DS Heavy-duty nail for fastening to concrete and steel

Product data

Dimensions

DS __ P10

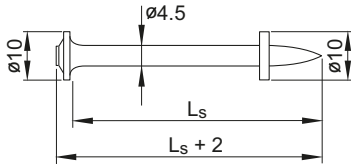

Material specifications

Carbon steel shank: HRC 54 (DS)
HRC 58 (DSH)

Zinc coating: 5–20 µm

Recommended fastening tools

DX 6 F10, DX 5 F10, DX 460 F10,
DX 76, DX 76 PTR

-  • See fastener program in the next pages.
- For more details, please refer to the chapter **Accessories and consumables compatibility** in the Direct Fastening Technology Manual (DFTM).

Approvals

ICC (USA) LR 97/00077

-  Not all information presented in this product data sheet might be subject to approval / certificate content. Please refer to approval / certificate for further information.

Applications

Examples

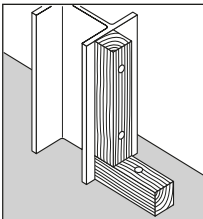

Wood to steel and concrete

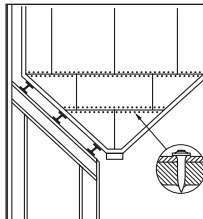

Plastic and rubber to steel

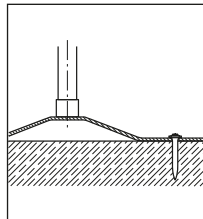

Metal parts to concrete

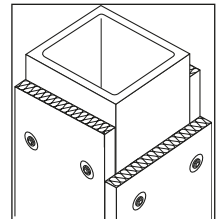

Soft material to steel and concrete

Performance data

Recommended resistance under tension and shear load

Fastening wood to concrete, sandlime masonry or steel

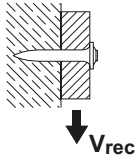
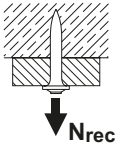

Fastening wood to concrete, sandlime masonry:

$$N_{rec} = V_{rec} = 0.4 \text{ kN}$$

Fastening wood to steel:

$$N_{rec} = V_{rec} = 0.6 \text{ kN}$$

Conditions

- For safety-relevant fastenings sufficient redundancy of the entire system is required: minimum 5 fastenings per fastened unit with normal weight concrete base material.
- All visible failures must be replaced.
- Valid for concrete and sandlime masonry with strength of $f_{cc} < 40 \text{ N/mm}^2$.
- Fastened material:

wood, minimum thickness	= 24 mm
plywood, minimum thickness	= 16 mm

Soft material

- Working loads depend on strength and thickness of material fastened. Do not use working loads in excess of those for wood.
- Depth of penetration and other conditions same as for fastening wood.
- Use R23 or R36 ($\varnothing 4.5 \text{ mm}$ hole) washer to control penetration and to increase pull-over strength. Separately available from Hilti.

Metal profiles to concrete

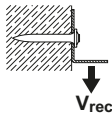
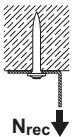

$$N_{rec} = V_{rec} = 0.4 \text{ kN}$$

- Minimum 5 fastenings per fastened unit (normal weight concrete)
- Increase to 600 N possible if 8 or more fastenings in each fastened unit.
- All visible failures must be replaced
- $t_j = 1\text{--}4 \text{ mm}$



- For more details in relation to base material properties, please refer to the chapter **Fastener selection guide** in the Direct Fastening Manual (DFTM).

Application recommendation

Base material thickness

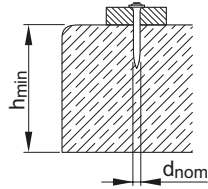

Concrete
 $h_{\min} = 100 \text{ mm}$ ($d_{\text{nom}} \geq 4.5 \text{ mm}$)

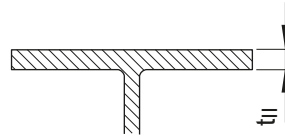

Steel
 $t_{II} \geq 6 \text{ mm}$

Fastened material thickness

$t_I \leq 50.0 \text{ mm}$

Fastener positioning

Edge distance: concrete (mm)

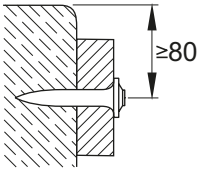

Edge distance: steel (mm)

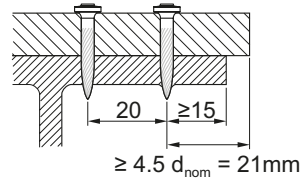

Spacing
 $a = 20 \text{ mm}$

Application limits

Steel

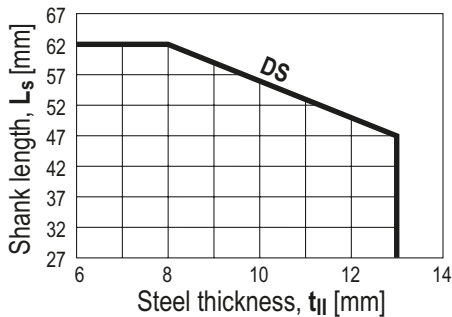

Fastener shanks length recommendation for fastening to concrete

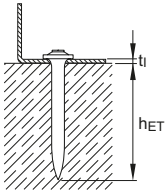

Required nail shank length:

Wood or

metal profiles $L_S = h_{ET} + t_l$ [mm]

Soft material $L_S = h_{ET} + t_l - 2 \cdot h_{CS}$ [mm]

$h_{CS} \approx 3$ mm if possible

Required depth of penetration h_{ET}

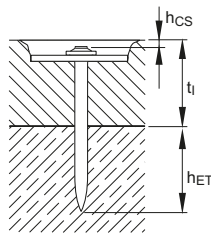
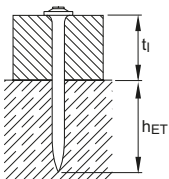

$h_{ET} \geq 27$ mm

Fastener shanks length recommendation for fastening to steel

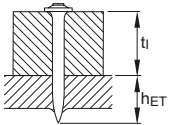

$h_{ET} = 17-27$ mm

Corrosion information



- The intended use for safety-relevant and permanent applications only comprises fastenings which are not directly exposed to external weather conditions or moist atmospheres.
- For more details, please refer to following technical document: Hilti Corrosion Handbook.

System recommendation

- For more details, please refer to the chapter **Accessories and consumables compatibility** in the Direct Fastening Technology Manual (DFTM).

Cartridge recommendation for fastening to concrete

Base material	Cartridge color (tool power level)		
	Tool type: DX 6 F10	Tool type: DX 5 F10, DX 460 F10	Tool type: DX 76, DX 76 PTR
	Cartridge type: 6.8/11 M	Cartridge type: 6.8/11 M	Cartridge type: 6.8/18 M
Sand lime masonry	titanium ■ (1-5)	green ■, yellow ■	
Soft/medium concrete	titanium ■ (2-8)	yellow ■, red ■	yellow ■, red ■
Tough concrete	titanium ■ (4-8), black ■ (7-8)	red ■, black ■	red ■

Cartridge recommendation for fastening to steel

Base material		Cartridge color (tool power level)		
		Tool type: DX 6 F10	Tool type: DX 5 F10, DX 460 F10	Tool type: DX 76, DX 76 PTR
		Cartridge type: 6.8/11 M	Cartridge type: 6.8/11 M	Cartridge type: 6.8/18 M
S235 to S355	$6 \leq t_{II} < 13 \text{ mm}$	titanium ■ (4-8), black ■ (7-8)	red ■, black ■	red ■, black ■

- Tool power level adjustment by setting tests on site.
- Start tool energy selection with lowest recommended tool power level.
- Correct according requirement from chapter quality assurance.

Quality assurance

Setting depth control

Fastening wood or soft material

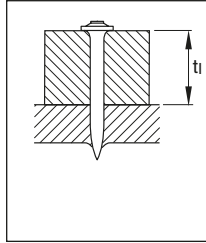
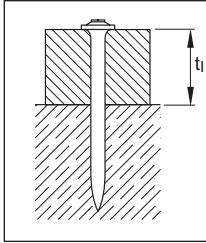

Fastening metal profiles

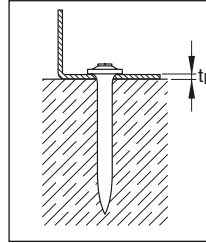

Flush setting of the nails

Fastener program

Designation	Item no.	LS [mm]	d _{nom} [mm]
DS 27 P10	46157	27	4.5
DS 32 P10	46158	32	4.5
DS 37 P10	46159	37	4.5
DS 42 P10	46160	42	4.5
DS 47 P10	46161	47	4.5
DS 52 P10	46162	52	4.5
DSH 57 P10	40591	57	4.5
DS 62 P10	46164	62	4.5
DS 72 P10	46165	72	4.5

Nail length limits are for use without pre-driving into the wood. Hand-driving the nail into the wood and bringing the DX tool into position over the nail head extend the nail length range for the tools.

EDS Nail for fastening to steel

Product data

Dimensions

EDS_P10

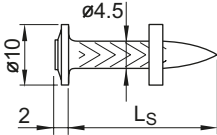

Material specifications

Carbon steel shank:

EDS 19/22

HRC 55.0

Zinc coating:

10–25 µm

Recommended fastening tools

DX 76, DX 76 PTR



- For more details, please refer to **EDS fastener program** and to the chapter **Accessories and consumables compatibility** in the Direct Fastening Technology Manual (DFTM).

Approvals and certificates

ICC (USA), ABS, LR, DNV-GL



- Not all information presented in this product data sheet might be subject to approval/certificate content. Please refer to approval/certificate for further information.

Applications

Example

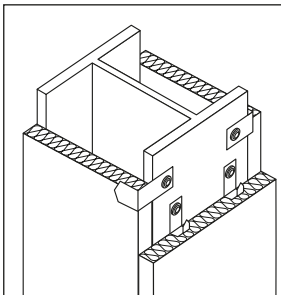

Metal clips

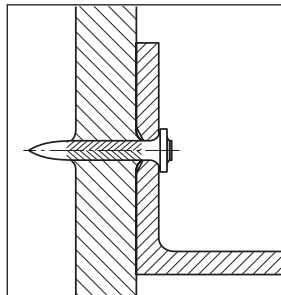

Angle bracket

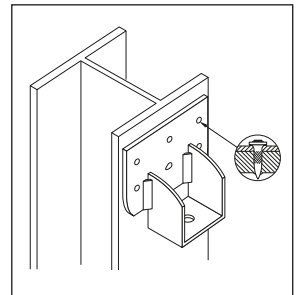

Mounting bracket

Performance data

Recommended loads (predominantly static)

Steel sheet fastening

t_f [mm]	EDS_P10	
	N_{rec} [kN]	V_{rec} [kN]
0.75	1.1	1.5
1.00	1.3	2.3
1.25	1.7	3.2
≥ 2.00	2.4	4.0

- Recommended loads valid for steel sheet with minimum tensile strength ≥ 360 N/mm².
- For intermediate sheet thicknesses, use recommended load for next smaller thickness.
- N_{rec} and V_{rec} include an overall safety factor of 3.0 applied to the characteristic test data.
 Static test: $N_{rec} = N_{test,k} / 3.0$, $V_{rec} = V_{test,k} / 3.0$

Forces of constraint

When fastening large pieces of steel, the possibility of shear loadings from forces of constraint should be considered. Avoid exceeding V_{rec} for the fastener shank!

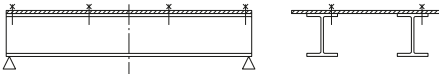

Deflection due to primary loading

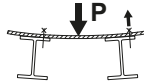
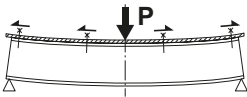

Temperature effect

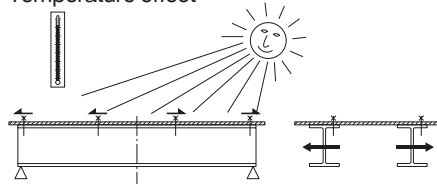

Application recommendation

Thickness of base material

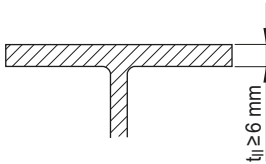

	t_{ij} (mm)
EDS	≥ 6

Thickness of fastened material

$t_f \leq 3$ mm

Steel fastened material ≤ 3 mm thick, usually deforms with the displaced base material to allow a tight fit between fastened steel and base material without pre-drilling.

Because conditions may vary, trial fastenings are recommended

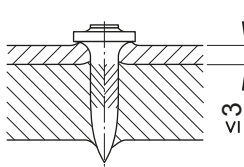

$t_f > 3$ mm

Without pre-drilling: steel fastened material > 3 mm thick is too stiff to deform entirely with the displaced base material. The gap, which increases with increasing t_f , can result in bending moments being applied to the nail shank.

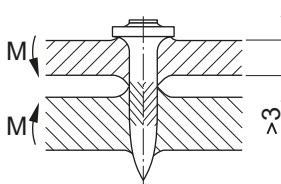

To prevent imposition of a moment on the shank of fastener, use three fasteners in a group.

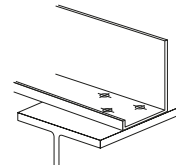

With pre-drilling:

If a gap between the fastened part and the base material is unacceptable, the fastened part can be prepared with drilled holes.

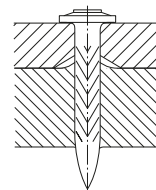
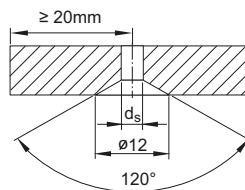

Spacing and edge distances (mm)

Base material

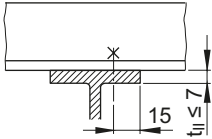

Fastened material

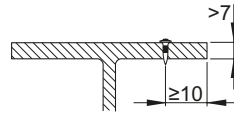
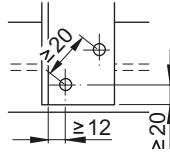

Application limits

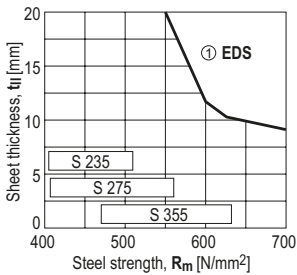

① EDS with DX76 and DX 76 PTR

- Limit line valid for steel, $t_I \leq 3$ mm
- For steel $t_I > 3$ mm and without pre-drilling, either make trial fastenings or adjust t_{II} to $t_{II} + t_I$ before using the chart.

Corrosion information



- The intended use only comprises fastenings which are not directly exposed to external weather conditions or moist atmospheres.
- For more details, please refer to following technical document: Hilti Corrosion Handbook.

Fastener program

Base material thickness	Fixed material thickness t_f [mm]									Fastener	Item no.	L_s [mm]	h_{ET} [mm]	DX tools
	≤1	2	3	5	6	7	8	9	13					
$t_{II, min} \geq 6$ mm	■	■	■	■						EDS 19 P10	46554	19	12-17	DX 76,
				■	■	■	■			EDS 22 P10	46556	22	12-17	DX76PTR

■ recommended thickness

$$L_s = h_{ET} + t_f$$

Cartridge recommendation

Cartridges 6.8/18 M red or black



- Tool power level adjustment by setting tests on site.
- Start tool energy selection with lowest recommended tool power level.
- Correct according requirement from chapter quality assurance.

Quality assurance

Fastening inspection

EDS __ P10

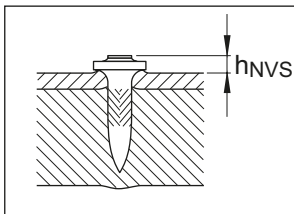

$$h_{NVS} = 3.0-4.0 \text{ mm}$$

X-R Stainless steel nail

Product data

Product description

X-R 14 P8



- Stainless steel nail
- Corrosion-resistant
- Designed for fastening on steel
- Engineered for high-quality, reliable fastening
- Suitable for universal use

Dimensions for nails

Technical drawing	Product	Shank length L_s	Head height L_h	Shank diameter d_s	Head diameter d_h	Head diameter $d_{washer1}$
	X-R 14 P8	14 mm	2.4 mm	3.7 mm	8.0 mm	8.0 mm

Material specification and material properties for stainless steel parts

Product type	Element	Material	Tensile strength R_m	Hardness
X-R P8	Nails	Stainless steel	2000 MPa	57 HRC

Material specification and material properties for plastic parts

Product type	Element	Material		
X-R P8	Plastic washer	Polyethylene (PE)		

Approvals and certificates

Authority	Approval/ certificate	Date of issue	Expiry date	Short description
American Bureau of Shipping (ABS)	21-2146145-PDA	08/21	08/26	<ul style="list-style-type: none"> - Fastening to steel for shipbuilding - Fastening to steel for off-shore - Fastening to steel for on-shore
Lloyd's register (LR)	LR 97/00078(E4)	01/19	01/24	<ul style="list-style-type: none"> - Fastening to steel for shipbuilding - Fastening to steel for off-shore - Fastening to steel for on-shore
ICC-ES	ESR-1663	03/21	03/23	- General purpose



- Information presented in this product data sheet is based on Hilti Technical Data. For the specific application please refer to the corresponding approval/certificate.

Applications

Fastening wall ties

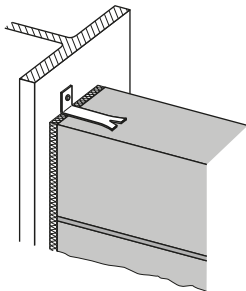

Fastening glas facade

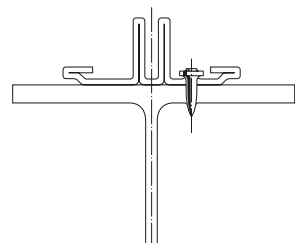
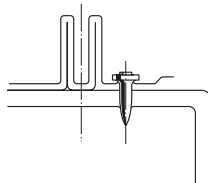

Base materials

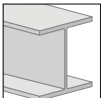

Steel

Load conditions



Static/
quasi static

Environmental conditions

Environmental condition		Product type
		X-R P8
	Dry indoor	■
	Indoor with temporary condensation	■
	Outdoor with low pollution	■
	Outdoor with moderate concentration of pollutants	■
	Coastal areas	■
	Outdoor, areas with heavy industrial pollution	■
	Close proximity to roads	■
	Special application, e.g. swimming pool	□
	Special application, e.g. tunneling	□

■ = suitable

□ = requires expert evaluation



- For more details, please refer to following technical document(s):
Hilti Corrosion Handbook.

Constraint forces

Technical drawing		Description
		No constraint forces, undisturbed system
		Constraint forces due to primary loading and deflection
		Constraint forces due to temperature effect



- When fastening large pieces of steel or aluminium, the possibility of shear loading due to forces of constraint must be taken into account in the fastening design. Allowance must be made for movement or, alternatively, forces of constraint must be taken into account in the design and maximum shear force limited by way of V_{rec} .

Fastener program

Product categorization

Designation		Technology	Product identifier	Shank length	Single nail fastening	Item no.
Product family	Steel nail					
Product line	X-R	X	R			
Product type	X-R P8	X	R	P8		
Product	X-R 14 P8	X	R	14	P8	2122461

Application recommendation for fastening to steel

Fastened material properties and fastener positioning in fastened material

	Fastened material type	Steel sheet	Aluminum sheet
	Fastened material	Carbon steel, stainless steel	Aluminum
	Fastened material tensile strength R_m	≥ 370 MPa	≥ 210 MPa
	Fastened material thickness t_f	0.75–3 mm	0.8–2.0 mm
	Edge distance c_{min}	12 mm (bordered by formed steel structure)	
	Edge distance c_{min}	20 mm	
	Fastener spacing s	≥ 20 mm	

Base material properties and fastener positioning in base material

	Base material	Steel
	Steel grade according to EN 10025-2	S235, S275, S355
	Base material tensile strength R_m	370–630 MPa
	Base material thickness t_{II}	5–10 mm
	Edge distance c_{min}	10 mm
	Edge distance c_{max}	$8 \times t_{II}$ mm

Rolled shape

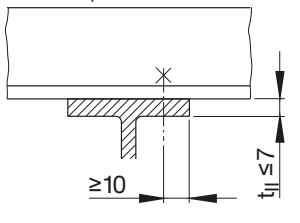

Cold formed shape

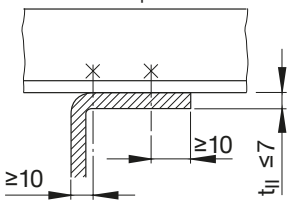

Fastener shank length recommendation

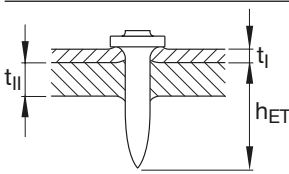

For standard fastening: $L_s = h_{ET} + t_I$
 $h_{ET} \geq 9 \text{ mm}$

Application limitation for fastening on steel

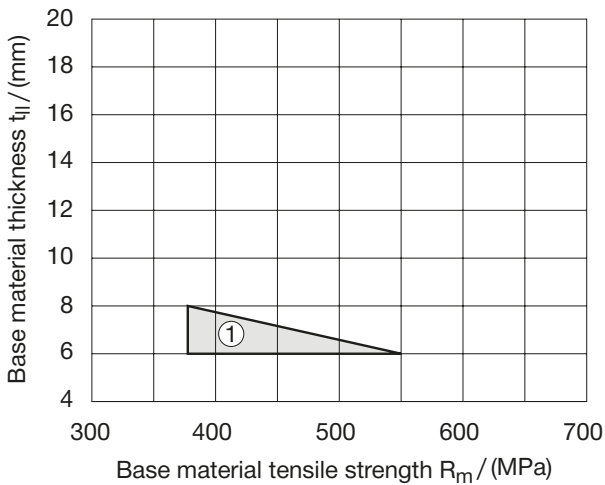

① X-R 14 P8 with DX 6 F8,
 X-R 14 P8 with DX 5 F8

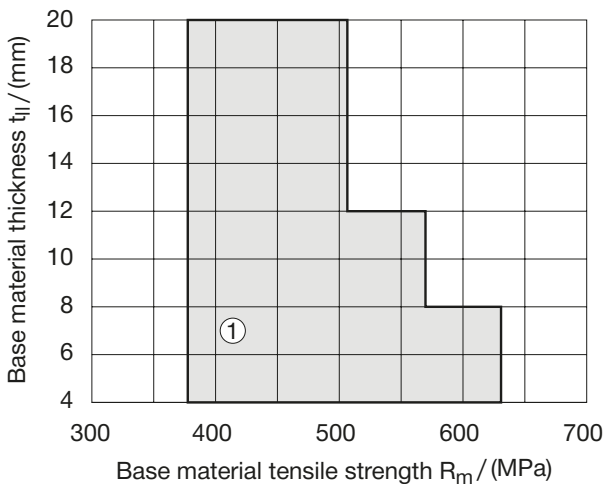

① X-R 14 P8 with DX 450-FA

Performance data

Recommended resistance under tension load, shear load and bending moment

Product	Fastened material	Fastened material thickness t_f	Tension load	Shear load	Bending moment
			N_{rec}	V_{rec}	M_{rec}
X-R 14 P8	Steel sheet	0.75 mm	1.0 kN	1.1 kN	-
		1.00 mm	1.2 kN	1.4 kN	
		1.25 mm	1.5 kN	1.7 kN	
		2.00 mm	2.2 kN	2.0 kN	
		2.50 mm	2.2 kN	2.0 kN	
	Aluminum sheet	0.80 mm	0.4 kN	0.4 kN	
		1.00 mm	0.6 kN	0.6 kN	
		1.20 mm	0.8 kN	0.9 kN	
		1.50 mm	1.1 kN	1.4 kN	
		2.00 mm	1.6 kN	1.7 kN	



- Glas facade application: fastened material thickness $t_{f, max} = 2.5$ mm.
- Fastened material failure is not considered.
- Recommended loads N_{rec} and V_{rec} are suitable for use in working load design concept:
 Characteristic acting load $N_s \leq N_{rec} = N_{Rk}/g_{global}$, with $g_{global} = 3.0$
 Characteristic acting load $V_s \leq V_{rec} = V_{Rk}/g_{global}$, with $g_{global} = 3.0$

System recommendation

System recommendation for fastening single nails with powder-actuated tools

Product	Powder-actuated tool							Base material		
	DX 6 F8	DX 5 F8	DX 450-FA					Steel S235	Steel S275	Steel S355
X-R 14 P8	<input type="checkbox"/>	<input type="checkbox"/>	<input checked="" type="checkbox"/>					<input checked="" type="checkbox"/>	<input checked="" type="checkbox"/>	<input checked="" type="checkbox"/>

■ = recommended

□ = feasible



- For more details, please refer to the chapter **Accessories and consumables compatibility** in the Direct Fastening Technology Manual (DFTM).

Cartridge recommendation

Base material		Cartridge color (tool power level)		
		Tool type: DX 6 F8	Tool type: DX 5 F8	Tool type: DX 450-FA
		Cartridge type: 6.8/11 M	Cartridge type: 6.8/11 M	Cartridge type: 6.8/11 M
S235- S355	$4 \leq t_{II} \leq 6 \text{ mm}$			yellow ■ (1-3)
	$6 \leq t_{II} \leq 8 \text{ mm}$	titanium ■ (6-8)	red ■ (3-4)	red ■ (2-3)
	$8 \leq t_{II} \leq 20 \text{ mm}$			red ■ (2.5-3)



- Tool power level adjustment by setting tests on site (see chapter quality assurance).
- Start tool energy selection with lowest recommended tool power level.
- Correct according requirement from chapter quality assurance.

Fastener stand-off

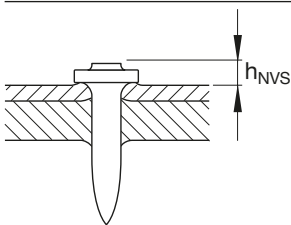

$$h_{NVS} = 3.0-4.5 \text{ mm}$$



- Visible setting failures must be replaced with a new fastener, not in the same hole.
- These are abbreviated instructions which may vary by application.
- Always review/follow the instructions accompanying the product.

X-CR Stainless steel nail for fastening to steel

Product data

Product description

X-CR P8



- Stainless steel nail
- Corrosion-resistant
- Designed for fastening on steel
- Engineered for high-quality, reliable fastening
- Suitable for universal use

Dimensions for nails without washer

Technical drawing	Product	Shank length L_s	Head height L_h	Shank diameter d_s	Head diameter d_h	Head diameter $d_{washer1}$
	X-CR 16 P8	16 mm	2.4 mm	3.7 mm	8.0 mm	8.0 mm
	X-CR 18 P8	16 mm				
	X-CR 21 P8	16 mm				

Material specification and material properties for stainless steel parts

Product type	Element	Material	Tensile strength R_m	Hardness
X-CR P8	Nails	Stainless steel	1800 MPa	51 HRC

Material specification and material properties for plastic parts

Product type	Element	Material		
X-CR P8	Plastic washer	Polyethylene (PE)		

Approvals and certificates

Authority	Approval/ certificate	Date of issue	Expiry date	Short description
American Bureau of Shipping (ABS)	21-2146145-PDA	08/21	08/26	<ul style="list-style-type: none"> - Fastening to steel for shipbuilding - Fastening to steel for off-shore - Fastening to steel for on-shore
Lloyd's register (LR)	LR 97/00078(E4)	01/19	01/24	<ul style="list-style-type: none"> - Fastening to steel for shipbuilding - Fastening to steel for off-shore - Fastening to steel for on-shore
ICC-ES	ESR-1663	03/21	03/23	- General purpose



- Information presented in this product data sheet is based on Hilti Technical Data. For the specific application please refer to the corresponding approval/certificate.

Applications

Fastening wall ties

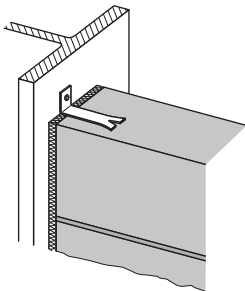

Base materials

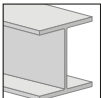

Steel

Load conditions



Static/
quasi static

Environmental conditions

Environmental condition		Product type
		X-CR P8
	Dry indoor	■
	Indoor with temporary condensation	■
	Outdoor with low pollution	■
	Outdoor with moderate concentration of pollutants	■
	Coastal areas	■
	Outdoor, areas with heavy industrial pollution	■
	Close proximity to roads	■
	Special application, e.g. swimming pool	□
	Special application, e.g. tunneling	□

■ = suitable

□ = requires expert evaluation



- For more details, please refer to following technical document(s):
Hilti Corrosion Handbook.

Constraint forces

Technical drawing	Description
	No constraint forces, undisturbed system
	Constraint forces due to primary loading and deflection
	Constraint forces due to temperature effect



- When fastening large pieces of steel or aluminium, the possibility of shear loading due to forces of constraint must be taken into account in the fastening design. Allowance must be made for movement or, alternatively, forces of constraint must be taken into account in the design and maximum shear force limited by way of V_{rec} .

Fastener program

Product categorization

Designation		Technology	Product identifier	Shank length	Collation type	Item no.
Product family	Steel nail					
Product line	X-CR	X	CR			
Product type	X-CR P8	X	CR		P8	
Product	X-CR 16 P8	X	CR	16	P8	247356
	X-CR 18 P8	X	CR	18	P8	247357
	X-CR 21 P8	X	CR	21	P8	247358

Application recommendation for fastening to steel

Fastened material properties and fastener positioning in fastened material

	Fastened material type	Steel sheet	Aluminum sheet
	Fastened material	Carbon steel, stainless steel	Aluminum
	Fastened material tensile strength R_m	≥ 370 MPa	≥ 210 MPa
	Fastened material thickness t_f	0.75–9 mm	0.8–2.0 mm
	Edge distance c_{min}	12 mm (bordered by formed steel structure)	
	Edge distance c_{min}	20 mm	
	Fastener spacing s	≥ 20 mm	

Base material properties and fastener positioning in base material

	Base material	Steel
	Steel grade according to EN 10025-2	S235, S275, S355
	Base material tensile strength R_m	360–630 MPa
	Base material thickness t_{II}	5–10 mm
	Edge distance c_{min}	10 mm
	Edge distance c_{max}	$8 \times t_{II}$ mm

Rolled shape

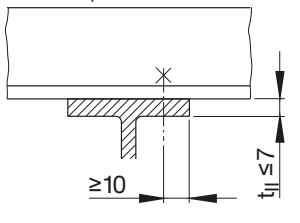

Cold formed shape

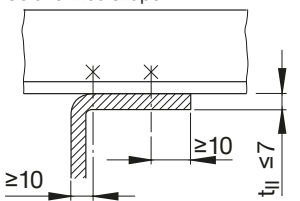

Fastener shank length recommendation

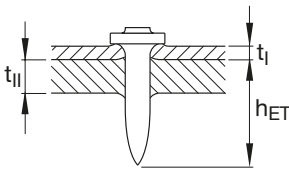

For standard fastening: $L_s = h_{ET} + t_I$

$h_{ET} \geq 9 \text{ mm}$

Application limitation for fastening on steel

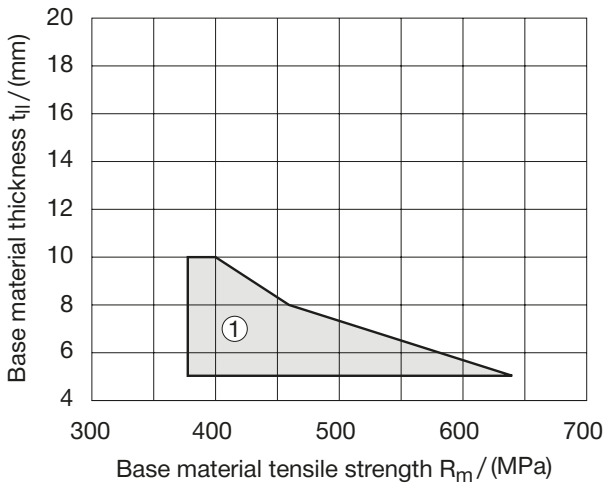

① X-CR 16 P8
with DX 450-FA

Performance data

Recommended resistance under tension load, shear load and bending moment

Product	Fastened material	Fastened material thickness t_f	Tension load	Shear load	Bending moment
			N_{rec}	V_{rec}	M_{rec}
X-CR 16 P8, X-CR 18 P8, X-CR 21 P8	Steel sheet	0.75 mm	1.0 kN	1.1 kN	-
		1.00 mm	1.2 kN	1.4 kN	
		1.25 mm	1.5 kN	1.7 kN	
		2.00 mm	2.2 kN	2.0 kN	
	Aluminum sheet	0.80 mm	0.4 kN	0.4 kN	
		1.00 mm	0.6 kN	0.6 kN	
		1.20 mm	0.8 kN	0.9 kN	
		1.50 mm	1.1 kN	1.4 kN	
X-CR 16 P8	Other steel applications, e.g. clips, brackets	3 mm	1.6 kN	2.0 kN	3.8 kN
X-CR 18 P8		5–6 mm	1.6 kN	2.0 kN	3.8 kN
X-CR 21 P8		8–9 mm	1.6 kN	2.0 kN	3.8 kN

- For intermediate fastened material thicknesses, use load for next smaller thickness.
- Fastened material failure is not considered.
- Recommended loads N_{rec} and V_{rec} are suitable for use in working load design concept:
 Characteristic acting load $N_s \leq N_{rec} = N_{Rk}/g_{global}$, with $g_{global} = 3.0$
 Characteristic acting load $V_s \leq V_{rec} = N_{Rk}/g_{global}$, with $g_{global} = 3.0$

System recommendation

System recommendation for fastening single nails with powder-actuated tools

Product	Powder-actuated tool							Base material		
	DX 6 F8	DX 5 F8	DX 450-FA					Steel S235	Steel S275	Steel S355
X-CR 16 P8	<input type="checkbox"/>	<input type="checkbox"/>	<input checked="" type="checkbox"/>					<input checked="" type="checkbox"/>	<input checked="" type="checkbox"/>	<input checked="" type="checkbox"/>
X-CR 18 P8	<input type="checkbox"/>	<input type="checkbox"/>	<input type="checkbox"/>					<input type="checkbox"/>	<input type="checkbox"/>	<input type="checkbox"/>
X-CR 21 P8	<input type="checkbox"/>	<input type="checkbox"/>	<input type="checkbox"/>					<input type="checkbox"/>	<input type="checkbox"/>	<input type="checkbox"/>

■ = recommended, □ = feasible

- For more details, please refer to the chapter **Accessories and consumables compatibility** in the Direct Fastening Technology Manual (DFTM).

Cartridge recommendation

Base material steel grade		Cartridge color (tool power level)		
		Tool type: DX 6 F8	Tool type: DX 5 F8	Tool type: DX 450-FA
		Cartridge type: 6.8/11 M10 for DX6	Cartridge type: 6.8/11 M10	Cartridge type: 6.8/11 M10
S235- S355	$5 \leq t_{II} \leq 6 \text{ mm}$			yellow ■ (1-3)
	$6 \leq t_{II} \leq 8 \text{ mm}$	titanium ■ (6-8)	red ■ (3-4)	red ■ (2-3)
	$8 \leq t_{II} \leq 10 \text{ mm}$			red ■ (2.5-3)



- Tool power level adjustment by setting tests on site (see chapter quality assurance).
- Start tool energy selection with lowest recommended tool power level.
- Correct according requirement from chapter quality assurance.

Fastener stand-off

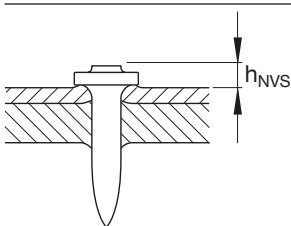

$$h_{NVS} = 3.0-4.5 \text{ mm}$$



- Visible setting failures must be replaced with a new fastener, not in the same hole.
- These are abbreviated instructions which may vary by application.
- Always review/follow the instructions accompanying the product.

X-CR Stainless steel nail for fastening to concrete, sand lime masonry and steel

Product data

Dimensions

X-CR __ P8

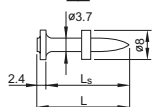

X-CR __ P8

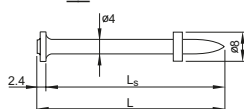

X-CR __ P8 S12

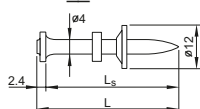

X-CR_P8 S15

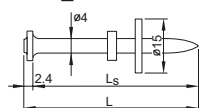

Material specifications

Nail shank: CrNiMo Alloy
 $f_u \geq 1800 \text{ N/mm}^2$
 (49 HRC)

Zinc coating: X-CR 48/52 P8 S15 has
 5–13 μm

Zinc coating to improve anchorage in concrete

Recommended fastening tools

DX 6, DX 5, DX 460, DX 36, DX 2, DX-E72

Approvals

ABS, LR: all types



i Not all information presented in this product data sheet might be subject to approval / certificate content. Please refer to approval/certificate for further information.

Applications

Examples

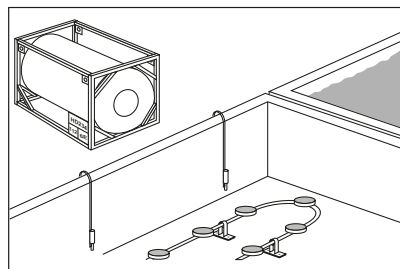

Exposure to weather or otherwise corrosive conditions

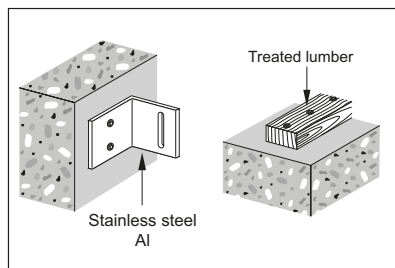

Noble or corrosive fastened material

Performance data

Recommended resistance under tension and shear load for DX Standard

Fastening wood to concrete, sandlime masonry or steel

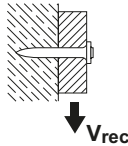
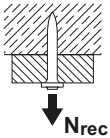

Fastening wood to concrete, sandlime masonry:

$$N_{rec} = V_{rec} = 0.4 \text{ kN}$$

Fastening wood to steel:

$$N_{rec} = V_{rec} = 0.6 \text{ kN}$$

Conditions

- For safety relevant fastenings sufficient redundancy of the entire system is required: minimum 5 fastenings per fastened unit with normal weight concrete base material.
- All visible failures must be replaced.
- Valid for concrete and sandlime masonry with strength of $f_{cc} < 40 \text{ N/mm}^2$.
- Valid for predominantly static loading.

Soft material

- Working loads depend on strength and thickness of material fastened. Do not use working loads in excess of those for wood.
- Depth penetration and other conditions same as for fastening wood
- Use R23 or R36 ($\varnothing 4.5 \text{ mm}$ hole) washer to control penetration and to increase pull-over strength. Separately available from Hilti.

Recommended resistance under tension and shear load for DX-Kwik (with pre-drilling)

	$N_{rec,1}$	$N_{rec,2}$	V_{rec}	M_{rec}
X-CR 39/44	2.0 kN	0.6 kN	2.0 kN	5.5 kN
X-CR 48	3.0 kN	0.9 kN	3.0 kN	5.5 kN

Conditions

- $N_{rec,1}$: concrete in compressive zone.
- $N_{rec,2}$: concrete in tension zone.
- Static or cyclic (5000 load applications) loading.
- $f_{cc} \geq 25 \text{ N/mm}^2$. For higher concrete strengths, higher loadings may be possible if supported by testing.
- A sufficient redundancy has to be ensured, that the failure of a single fastening will not lead to collapse of the entire system.
- Recommended loads are based on failure of the fastener anchorage in the concrete. Thickness and quality of the fastened material may lower the loadings.
- Observance of all pre-drilling requirements, fastened thickness limits, and recommended details.



- For more details in relation to base material properties, please refer to the chapter **Fastener selection guide** in the Direct Fastening Manual (DFTM).

Application recommendation

Base material thickness

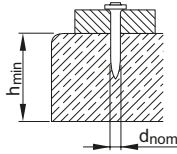

Concrete

$h_{min} = 80 \text{ mm}$ ($d_{nom} = 3.7 \text{ mm}$)

$h_{min} = 90 \text{ mm}$ ($d_{nom} \geq 4.0 \text{ mm}$)

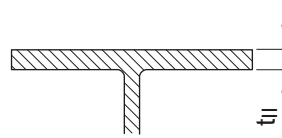

Steel

$t_{II} \geq 5 \text{ mm}$ for fastening of wood

Fastened material thickness

$t_1 \leq 25.0 \text{ mm}$ (detailed information see fastener selection)

Fastener positioning in base material

Pairs

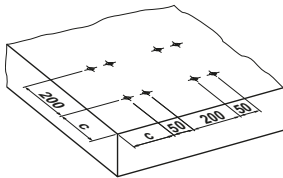

	reinforced*	non-reinforced
c	100 mm	150 mm

Row along edge

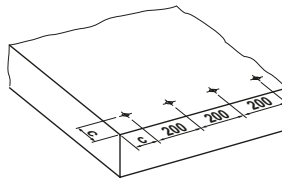

	reinforced*	non-reinforced
c	80 mm	150 mm

General

(e.g. group of fasteners)

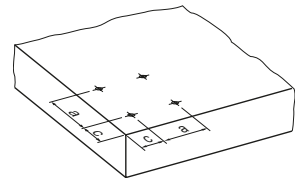

	reinforced*	non-reinforced
c	80 mm	150 mm
a	80 mm	100 mm

* Minimum $\varnothing 6 \text{ mm}$ reinforcing steel continuous along all edges and around all corners. Edge bar must be enclosed by stirrups.

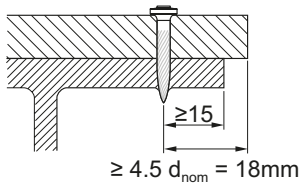

Application limits

Steel

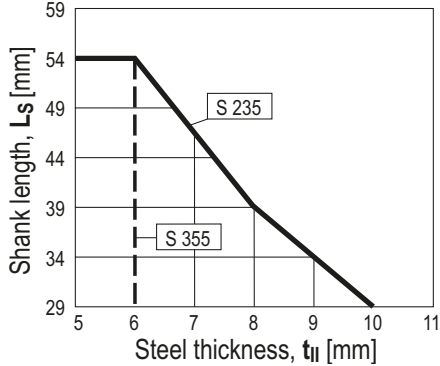

Fastener shanks length recommendation for DX Standard

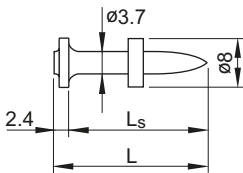

Wood: $L_s = h_{ET} + t_t$ [mm]
 Soft material: $L_s = h_{ET} + t_t - 2.4 - h_{CS}$ [mm]
 $h_{CS} \approx 3$ mm if possible

Required depth of penetration h_{ET}

Normal weight concrete NWC

f_{CC} [N/mm ²]	15	25	35
h_{ET} [mm]	32	27	22

Sandlime masonry SLM

f_{CC} [N/mm ²]	15	25	35
h_{ET} [mm]	32	27	27

• h_{ET} according to concrete strength f_{CC} .

Light weight concrete LWC

$h_{ET} = 32-37$ mm

Steel

$h_{ET} \geq 10$ mm

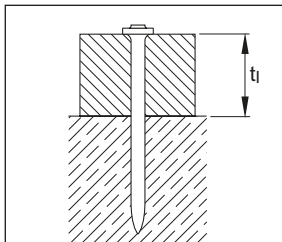

Normal weight concrete NWC

268

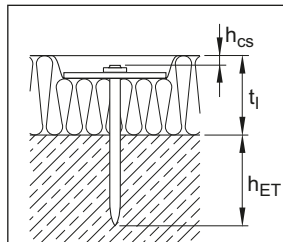

Sandlime masonry SLM

www.hilti.group

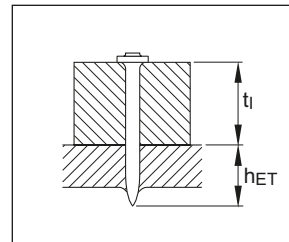

Steel

04/2021

Corrosion information

- For fastenings exposed to weather or other corrosive conditions. Not for use in highly corrosive surroundings like swimming pools or highway tunnels.
- For more details, please refer to following technical document: Hilti Corrosion Handbook.

System recommendation

- For more details, please refer to the chapter **Accessories and consumables compatibility** in the Direct Fastening Technology Manual (DFTM).

Cartridge recommendation for fastening to masonry and concrete

Base material	Cartridge color (tool power level)	
	Tool type: DX 6 F8	Tool type: DX 5 F8, DX 460 F8, DX 2
	Cartridge type: 6.8/11 M	Cartridge type: 6.8/11 M
Sand lime masonry	titanium ■ (1-3)	green ■
Soft/medium concrete	titanium ■ (2-8)	yellow ■, red ■

Cartridge recommendation for fastening to concrete with Kwik method (incl. pre-drilling)

Base material	Cartridge color (tool power level)	
	Tool type: DX 6 F8	Tool type: DX 5 F8, DX 460 F8, DX 2
	Cartridge type: 6.8/11 M	Cartridge type: 6.8/11 M
Soft/medium concrete	titanium ■ (4-8)	red ■
Tough concrete	titanium ■ (4-8)	red ■

Cartridge recommendation for fastening to steel

Base material		Cartridge color (tool power level)	
		Tool type: DX 6 F8	Tool type: DX 5 F8, DX 460 F8
		Cartridge type: 6.8/11 M	Cartridge type: 6.8/11 M
S235 to S355	$5 \leq t_{ } < 10 \text{ mm}$	titanium ■ (2-8)	yellow ■, red ■

- Tool power level adjustment by setting tests on site.
- Start tool energy selection with lowest recommended tool power level.
- Correct according requirement from chapter quality assurance.

Quality assurance

Installation instruction for DX-Kwik: Pre-drilling details (not through fastened material)

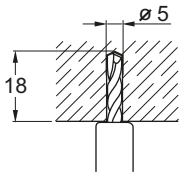

X-CR 39 / X-CR 44

Fastener	t_f [mm]	Drill bit	Item no
X-CR 39	≤ 2	TX-C-5/18	00061793
X-CR 44	2-7	TX-C-5/18	

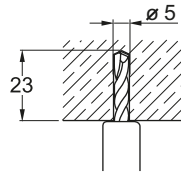

X-CR 48 / X-CR 52

Fastener	t_f [mm]	Drill bit	Item no
X-CR 48	≤ 5	TX-C-5/23	00061787
X-CR 52	5-9	TX-C-5/23	00061787

Details valid for C20/25 – C45/55 ($f_{cc} = 25-55 \text{ N/mm}^2$ / $f_c = 20-45 \text{ N/mm}^2$)

Installation instruction for DX-Kwik: Pre-drilling details (through fastened material)

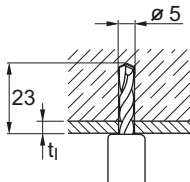

X-CR 48

Fastener	t_f [mm]	Drill bit	Item no
X-CR 48	≤ 2	TX-C-5/23	00061787

Details valid for C20/25 – C50/60



- These are abbreviated instructions which may vary by application.
- Always review/follow the instructions accompanying the product.

Fastener program

Fasteners		Tool		
Designation	Item no	L _S	d _{nom}	Designation
X-CR 24 P8	247359	24 mm	3.7 mm	DX 6, DX 5, DX 460, DX 36, DX 2, DX-E 72 ¹⁾
X-CR 29 P8	247360	29 mm	3.7 mm	DX 6, DX 5, DX 460, DX 36, DX 2, DX-E 72 ¹⁾
X-CR 34 P8	247361	34 mm	3.7 mm	DX 6, DX 5, DX 460, DX 36, DX 2, DX-E 72 ¹⁾
X-CR 39 P8	247362	39 mm	4.0 mm	DX 6, DX 5, DX 460, DX 36, DX 2, DX-E 72 ¹⁾
X-CR 44 P8	247363	44 mm	4.0 mm	DX 6, DX 5, DX 460, DX 36, DX 2, DX-E 72 ¹⁾
X-CR 54 P8	247429	54 mm	4.0 mm	DX 6, DX 5, DX 460, DX 36, DX 2, DX-E 72 ¹⁾
X-CR 39 P8 S12	247354	39 mm	4.0 mm	DX 6, DX 5, DX 460, DX 36, DX 2 ²⁾
X-CR 44 P8 S12	247355	44 mm	4.0 mm	DX 6, DX 5, DX 460, DX 36, DX 2 ²⁾
X-CR 48 P8 S15	258121	48 mm	4.0 mm	DX 6, DX 5, DX 460, DX 36, DX 2 ²⁾
X-CR 52 P8 S15	2052687	52 mm	4.0 mm	DX 6, DX 5, DX 460
X-CR-FOX 53 P8 S15 ³⁾	2305190	53 mm	4.0 mm	DX 6, DX 5, DX 460

¹⁾ DX Standard (without pre-drilling)

²⁾ DX-Kwik (with pre-drilling)

³⁾ Fastener for fixing Hilti brackets MFT-FOX V, MFT-FOX VI
(For more details, please refer to ETA-14/0426)

X-CT Nail for forming or other temporary use

Product data

Dimensions

X-CT __ MX, X-CT __ DP8

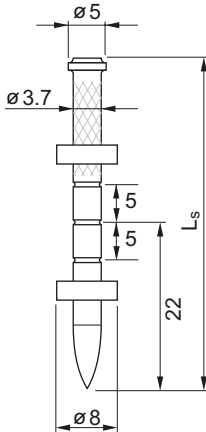

Material specifications

Carbon steel shank: HRC 53

Zinc coating: 5–20 μm

Recommended fastening tools

DX 6 MX, DX 5 MX, DX 460 MX

DX 6-F8, DX 5-F8, DX 460-F8, DX 36, DX 2, DX-E72

i • See fastener program in the next pages.

Applications

Examples

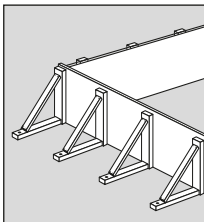

Conventional Formwork

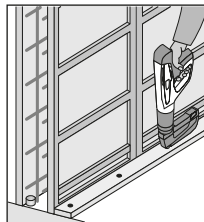

System Formwork

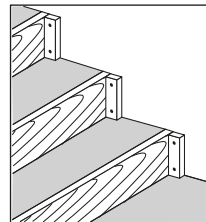

To position and hold concrete formwork

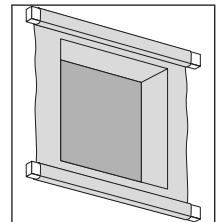

Fasten plastic, netting, etc.

Performance data

Recommended resistance under shear load

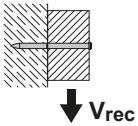

$$V_{rec} = 0.3 \text{ kN for } h_{ET} \geq 22 \text{ mm}$$

Conditions

- Static loading only (placing and vibration of concrete does not affect design).
- Minimum 5 fastenings per fastened unit.



- For more details in relation to base material properties, please refer to the chapter **Fastener selection guide** in the Direct Fastening Manual (DFTM).

Application recommendation

Base material and fastened material thickness

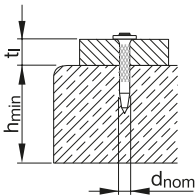

$$h_{min} = 80 \text{ mm}$$

$$t_f = 20\text{--}50 \text{ mm}$$

Fastener positioning

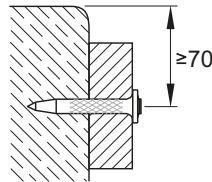

Edge distances $c \geq 70 \text{ mm}$

Fastener shank length recommendation

Required nail shank length

$$L_S = h_{ET} + t_f \text{ [mm]}$$

Recommendation

Concrete

$$h_{ET} = 22 \text{ mm}$$

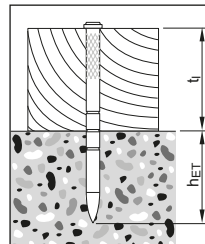

System recommendation

- For more details, please refer to the chapter **Accessories and consumables compatibility** in the Direct Fastening Technology Manual (DFTM).

Cartridge recommendation

Base material	Cartridge color (tool power level)	
	Tool type: DX 6 MX DX 6 F8	Tool type: DX 5 MX, DX 460 MX DX 5 F8, DX 460 F8, DX 2
	Cartridge type: 6.8/11 M	Cartridge type: 6.8/11 M
Sand lime masonry	titanium ■ (1-3)	green ■
Soft/medium concrete	titanium ■ (1-5)	green ■, yellow ■

- Tool power level adjustment by setting tests on site.
- Start tool energy selection with lowest recommended tool power level.

Fastener program

Fasteners					Tools				Description
Designation	Item no. Packs of 1000 nails	100 nails	L _s [mm]	d _{nom} [mm]	DX 6 MX, DX 5 MX, DX 460 MX	DX 6 F8, DX 5 F8, DX 460 F8	DX 2, DX 36	DX EZ	
X-CT 47 MX	383588		47	3.7	■				Wood to concrete
X-CT 52 MX	383589	383576	52	3.7	■				Wood to concrete
X-CT 62 MX	383591	383579	62	3.7	■				Wood to concrete
X-CT 72 MX		383580	72	3.7	■				Wood to concrete
X-CT 47 DP8		383582	47	3.7	■	■	■	■	Wood to concrete
X-CT 52 DP8		383583	52	3.7	■	■	■	■	Wood to concrete
X-CT 62 DP8		383585	62	3.7	■	■	■	■	Wood to concrete
X-CT 72 DP8		383586	72	3.7	■	■	■	■	Wood on concrete (with pre-hammering)
X-CT 97 DP8		383587	97	3.7	■	■	■	■	Wood on concrete (with pre-hammering)

■ recommended
■ feasible

DX-Kwik – X-M6 H, X-M8 H and DNH, X-DKH Threaded studs and nails

Product data

Dimensions

X-M6H-__-37 P8

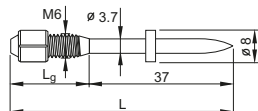

X-M8H-__-37 P8

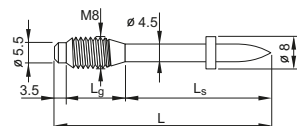

DNH 37 P8S15

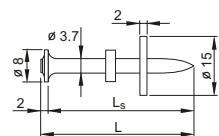

X-DKH 48 P8S15

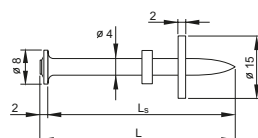

Material specifications

Carbon steel shank: HRC 58

Zinc coating: 5–20 µm

Recommended fastening tools

DX 6 F8, DX 5 F8, DX 460 F8, DX 2

i • See fastener program in the next pages.

Approvals

IBMB 3041/8171

X-M8H, X-DKH, X-M6H

DIBt (Germany):

X-M8H

i Not all information presented in this product data sheet may be subject to approval / certificate content. Please refer to approval/certificate for further information.

Applications

Examples

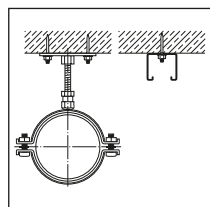

Base plates,
rails for piping

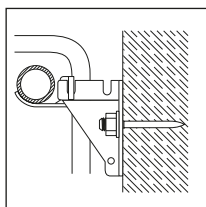

Radiator brackets

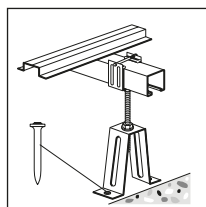

Floor stands, metal
fixtures to concrete

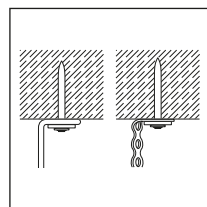

Suspended ceilings

Performance data

Recommended resistance under tension and shear load

	$N_{rec,1}$	$N_{rec,2}$	$V_{rec,1}$	$M_{rec,1}$
X-M6H, DNH 37	2.0 kN	0.6 kN	2.0 kN	5.5 kN
X-M8H, X-DKH 48	3.0 kN	0.9 kN	3.0 kN	10.0 kN

Conditions

- $N_{rec,1}$: concrete in compressive zone.
- $N_{rec,2}$: concrete in tension zone.
- Predominantly static loading.
- Concrete C20/25–C50/60.
- A sufficient redundancy has to be ensured, that the failure of a single fastening will not lead to collapse of the entire system.
- Recommended loads are based on failure of the fastener anchorage in the concrete.

Thickness and quality of the fastened material may lower the loadings.

– Observance of all pre-drilling requirements, fastened thickness limits, and recommended details.

– The recommended loads in the table refer to the resistance of the individual fastening and may not be the same as the loads F_N and F_V acting on the fastened part.

Note: If relevant, prying forces need to be considered in design, see example.

Moment acting on fastener shank only in case of a gap between base and fastened material.



- For more details in relation to base material properties, please refer to the chapter **Fastener selection guide** in the Direct Fastening Manual (DFTM).

Arrangements to prevent moment on shank

Coupler tight against concrete

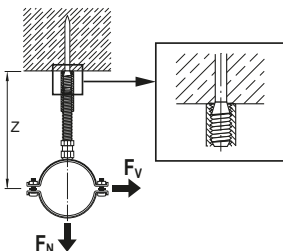

Non-symmetric arrangement

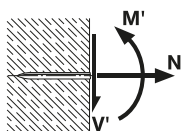
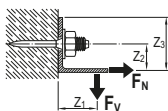

Resultant forces on nail

- Moment on fastened part
- Prying effect must be considered in determining loads acting on fastener

Application recommendation

Base material thickness

X-M6H, DNH 37: $h_{\min} = 100 \text{ mm}$

X-M8H, X-DKH 48: $h_{\min} = 100 \text{ mm}$

Fastened material thickness

X-M6H: $t_l \leq L_g - t_{\text{washer}} - t_{\text{nut}} \cong \text{up to } 13.5 \text{ mm}$

X-M8H: $t_l \leq L_g - t_{\text{washer}} - t_{\text{nut}} \cong \text{up to } 14.0 \text{ mm}$

DNH 37: $t_l \leq 2.0 \text{ mm}$

X-DKH 48: $t_l \leq 5.0 \text{ mm}$ or $t_l \leq 2.0$ by pre-drilling through fastened material

Fastener positioning in base material

Pairs

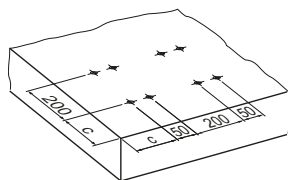

	Reinforced	Non-reinforced
c	100 mm	150 mm

Row along edge

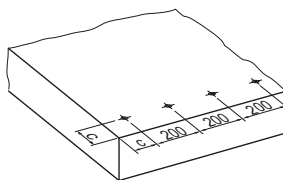

	Reinforced	Non-reinforced
c	80 mm	150 mm

General (e.g. group of fasteners)

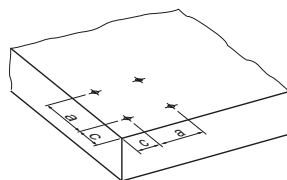

	Reinforced	Non-reinforced
c	80 mm	150 mm
a	80 mm	100 mm

Corrosion information



- The intended use only comprises fastenings which are not directly exposed to external weather conditions or moist atmospheres.
- For more details, please refer to following technical document: Hilti Corrosion Handbook.

System recommendation



- For more details, please refer to the chapter **Accessories and consumables compatibility** in the Direct Fastening Technology Manual (DFTM).

Cartridge recommendation

Base material	Cartridge color (tool power level)	
		Tool type: DX 6 F8
	Cartridge type: 6.8/11 M	Cartridge type: 6.8/11 M
Soft/medium concrete	titanium ■ (2-6)	yellow ■, red ■
Tough concrete	titanium ■ (4-8)	yellow ■, red ■



- Tool power level adjustment by setting tests on site.
- Start tool energy selection with lowest recommended tool power level.
- Correct according requirement from chapter quality assurance.

Quality assurance

Fastening inspection

X-M6H, X-M8H

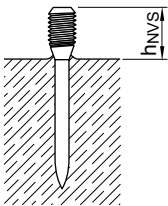

$$h_{NVS} = L - h_{ET}, \quad h_{ET} = 37-41 \text{ mm}$$

DNH 37, X-DKH 48

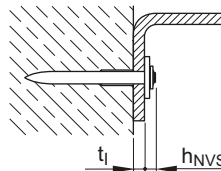

$$h_{NVS} \approx 4 \text{ mm}$$

Place nails so that heads and washers bear tightly against each other and against the fastened material

Installation

X-M6H, X-M8H

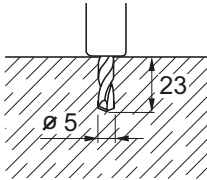

Pre-drill with drill bit

Designation	Item no
TX-C-5/23B	28557
or	
TX-C-5/23	61787

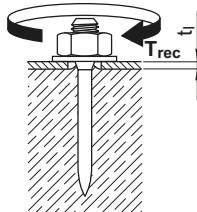

Tightening torque

Designation	T _{rec} [Nm]
X-M6H	6.5
X-M8H	10.0

DNH 37, X-DKH 48

Pre-drilling details (not through fastened material)

DNH 37

t _i [mm]	Drill-bit	Item no.
≤ 2	TX-C-5/18	61793

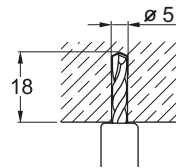

X-DKH 48

t _i [mm]	Drill-bit	Item no.
≤ 5	TX-C-5/23B	28557
or		
	TX-C-5/23	00061787

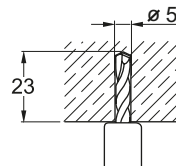

Details valid for C20/25–C50/60

Pre-drilling details (through fastened material)

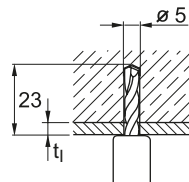

X-DKH 48

t _i [mm]	Drill-bit	Item no.
≤ 2	only TX-C5/23	61787

Details valid for C20/25–C50/60

These are abbreviated instructions which may vary by application.

ALWAYS review/follow the instructions accompanying the product.

Fastener program

Fastened thickness $t_{i,max}$ [mm]	Fastener				
	Designation	Item no.	L_g [mm]	L_s [mm]	L [mm]
-	X-M6H-10-37 FP8	40464	10	37	47
-	X-M8H-10-37 P8	20059	10	37	50.5
5.0	X-M8H/5-15-37 P8	26325	15	37	55.5
15.0	X-M8H/15-25-37 P8	20064	25	37	65.5
2.0	DNH 37 P8S15	44165	-	37	39
5.0*	X-DKH 48 P8S15	40514	-	48	50

*) with pre-drilling through fastened material $t_{i,max} = 2.0$ mm

X-M6, X-W6, X-M8, M10, W10

Threaded stud for fastening to concrete

Product data

Dimensions

X-M6/W6 ____ FP8

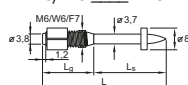

X-M8 ____ P8

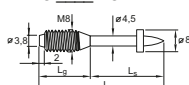

M10-24-32 P10

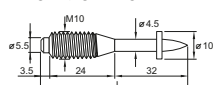

W10 ____ P10

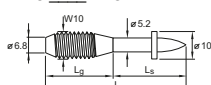

Material specifications

Carbon steel shank: HRC 53.5

Zinc coating: 5–20 μm

Recommended fastening tools

DX 6, DX 5, DX 460, DX 351, DX 36, DX 2, DX E72, DX 76, DX 76 PTR, DX 600 N



- See fastener program in the next pages.

Approvals

ICC (USA): X-W6, W10

UL, FM: W10



- Not all information presented in this product data sheet might be subject to approval / certificate content. Please refer to approval/certificate for further information.

Applications

Examples

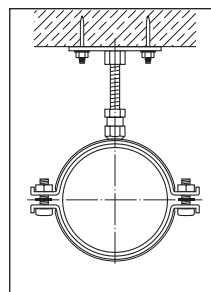

Plates for pipe rings

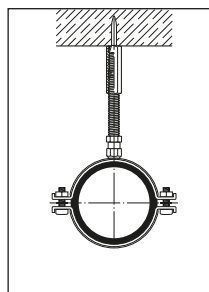

Hangings with threaded couplers

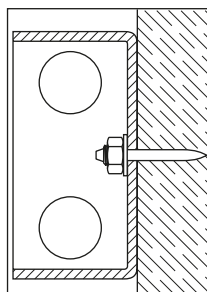

Electrical boxes

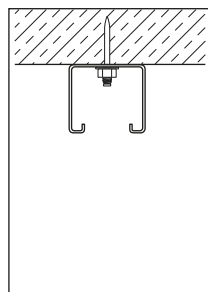

Miscellaneous attachments

Performance data

Recommended resistance

Designation	Shank diameter d_s	Bending moment M_{rec}
X-M6/W6	3.7 mm	5.0 Nm
X-M8, M10	4.5 mm	9.0 Nm
W10	5.2 mm	14.0 Nm

Recommended resistance for X-M6/W6, X-M8, M10, W10

$N_{rec} = V_{rec} =$	0.4 kN for $h_{ET} \geq 27$ mm
$N_{rec} = V_{rec} =$	0.3 kN for $h_{ET} \geq 22$ mm
$N_{rec} = V_{rec} =$	0.2 kN for $h_{ET} \geq 18$ mm

Arrangements to prevent moment on shank

Coupler tight against concrete

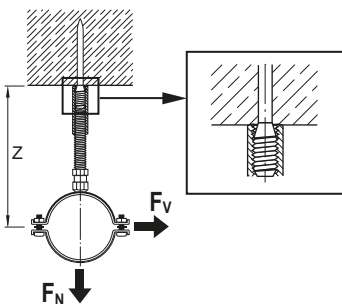
Non-symmetric arrangement

- Moment on fastened part
- Prying effect must be considered in determining loads acting on fastener

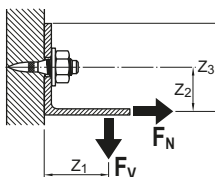
Conditions

- Minimum 5 fastenings per fastened unit (normal weight concrete)
- All visible failures must be replaced.
- With lightweight concrete base material and greater loading may be possible, please contact Hilti.
- Predominantly static loading.
- Observance of all application limitations and recommendations.
- The recommended loads in the table refer to the resistance of the individual fastening and may not be the same as the loads F_N and F_V acting on the fastened part.

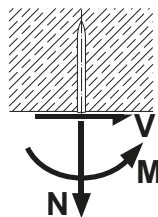

Note: If relevant, prying forces need to be considered in design, see example. Moment acting on fastener shank only in case of a gap between base and fastened material.



- For more details in relation to base material properties, please refer to the chapter **Fastener selection guide** in the Direct Fastening Manual (DFTM).

Application recommendation

Base material thickness

$h_{\min} = 80 \text{ mm}$ ($d_{\text{nom}} = 3.7 \text{ mm}$)

$h_{\min} = 100 \text{ mm}$ ($d_{\text{nom}} \geq 4.5 \text{ mm}$)

Fastened material thickness

M6: $t_l \leq L_g - t_{\text{washer}} - t_{\text{nut}} \cong \text{up to } 15 \text{ mm}$

W6: $t_l \leq L_g - t_{\text{washer}} - t_{\text{nut}} \cong \text{up to } 33 \text{ mm}$

M8: $t_l \leq L_g - t_{\text{washer}} - t_{\text{nut}} \cong \text{up to } 15 \text{ mm}$

M10: $t_l \leq L_g - t_{\text{washer}} - t_{\text{nut}} \cong \text{up to } 19 \text{ mm}$

W10: $t_l \leq L_g - t_{\text{washer}} - t_{\text{nut}} \cong \text{up to } 25 \text{ mm}$

Fastener positioning in base material

Pairs

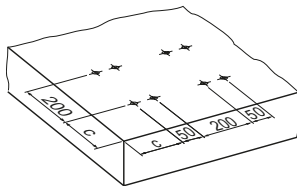

Reinforced * Non-reinforced

c 100 mm 150 mm

Row along edge

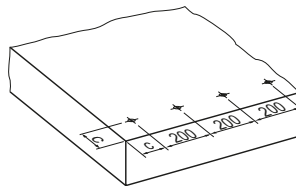

Reinforced * Non-reinforced

c 80 mm 150 mm

General (e.g. group of fasteners)

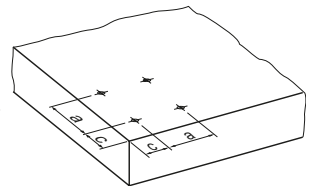

Reinforced * Non-reinforced

c 80 mm 150 mm
a 80 mm 100 mm

* Minimum $\varnothing 6$ reinforcing steel continuous along all edges and around all corners. Edge bars must be enclosed by stirrups.

Fastener shank length recommendation

Required thread length

$L_g \geq t_l + t_{\text{washer}} + t_{\text{nut}}$ [mm]

Corrosion information

- The intended use only comprises fastenings which are not directly exposed to external weather conditions or moist atmospheres.
- For more details, please refer to following technical document: Hilti Corrosion Handbook.

System recommendation

- For more details, please refer to the chapter **Accessories and consumables compatibility** in the Direct Fastening Technology Manual (DFTM).

Cartridge recommendation

Base material	Cartridge color (tool power level)	
		Tool type: DX 6 F8
	Cartridge type: 6.8/11 M	Cartridge type: 6.8/11 M
Soft/medium concrete	titanium ■ (2-6)	yellow ■, red ■
Tough concrete	titanium ■ (4-8)	yellow ■, red ■

Cartridge recommendation

Base material	Cartridge color (tool power level)	
		Tool type: DX 76, DX 76 PTR
	Cartridge type: 6.8/18 M	Cartridge type: 6.8/11
Soft/medium concrete	yellow ■, red ■	yellow ■, red ■
Tough concrete	yellow ■, red ■	yellow ■, red ■

- Tool power level adjustment by setting tests on site.
- Start tool energy selection with lowest recommended tool power level.
- Correct according requirement from chapter quality assurance.

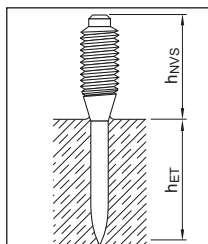
Quality assurance
Fastening inspection
X-M6 / W6
Penetration depth

$$h_{NVS} = L_g \pm 2$$

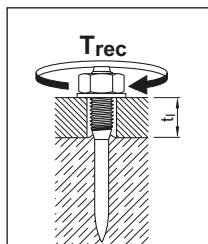
Tightening torque

$$T_{rec} \leq 4 \text{ Nm}$$

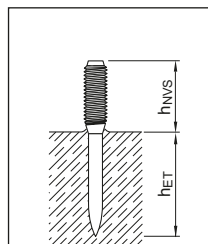
X-M8, M10, W10
Penetration depth

$$h_{NVS} = L_g \pm 2$$

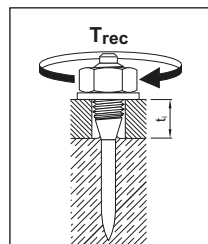
Tightening torque

$$T_{rec} \leq 6 \text{ Nm}$$

Fastener program

Fasteners					Tool
Group ¹⁾	Designation	Item no.	Standard threading ²⁾ L _g [mm]	Standard shank lengths ²⁾ L _S [mm]	Designation
M6	X-M6-20-27FP8	306079	20	27	DX 6, DX 5, DX 460, DX 351, DX 36, DX 2, DX E72
W6	X-W6-20-22FP8	306073	20	22	DX 6, DX 5, DX 460, DX 351, DX 36, DX 2, DX E72
	X-W6-20-27FP8	306074	20	27	DX 6, DX 5, DX 460, DX 351, DX 36, DX 2, DX E72
	X-W6-38-27FP8	306075	38	27	DX 6, DX 5, DX 460, DX 36, DX 2, DX E72
M8	X-M8-15-27P8	306092	15	27	DX 6, DX 5, DX 460, DX 36, DX 2, DX E72
	X-M8-15-42P8	306094	15	42	DX 6, DX 5, DX 460, DX 36, DX 2, DX E72
	X-M8-20-32P8	306096	20	32	DX 6, DX 5, DX 460, DX 36, DX 2, DX E72
M10	M10-24-32P10	26413	24	32	DX 76, DX 76 PTR
W10	W10-30-27P10	26472	30	27	DX 600 N
	W10-30-32P10	26473	30	32	DX 600 N
	W10-30-42P10	26476	30	42	DX 600 N

¹⁾ Type threading: M = metric; W6, W10 = Whitworth 1/4"; 3/8"

²⁾ Standard threading and shank lengths. Other lengths and combinations available on special order.



X-EM6H, X-EW6H, X-EF7H, X-EM8H, X-EM10H, X-EW10H

Threaded stud for fastening to steel

Product data

Dimension

X-EM6H/EW6H-__-9 FP8

X-EF7H-7-9 FP8

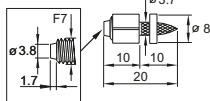
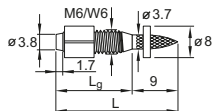

X-EM8H-__-12 P8

X-EM8H-15-12 FP10

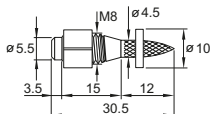
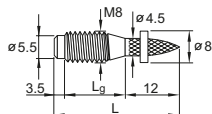

X-EM10H-24-12 P10

X-EW10H-30-14 P10

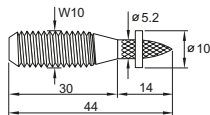
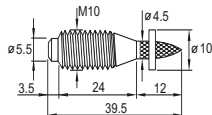

For dimension details see chapter fastener selection

Material specification

Carbon steel shank: HRC 56.5

Zinc coating: ¹⁾ 5–13 µm

¹⁾ Zinc coating (electroplating for corrosion protection during construction and service in protected environment)

Recommended fastening tool

DX 6, DX 5, DX 460, DX 76, DX 76 PTR,
DX 600 N



• See fastener program in the next pages.

Approval

ICC-ES ESR-2347 X-EW6H, X-EW10H,
(USA):

FM 3026695: X-EW6H, X-EW10H

UL: EX2258: X-EW6H, X-EW10H

ABS, LR: all types



• Not all information presented in this product data sheet might be subject to approval/certificate content. Please refer to approval/certificate for further information.

Environmental condition

Environmental condition	Fastener X-EM6H, EW6H, X-EF7H X-EM8H, X-EW8H, X-EM10H, X-EW10H
Dry indoor non-corrosive environment	■



• For more details, please refer to following technical document: Hilti Corrosion Handbook.

Application

Example:

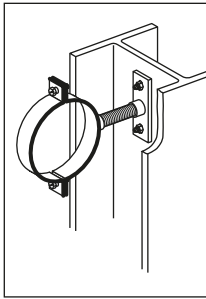

Base plates for pipe rings

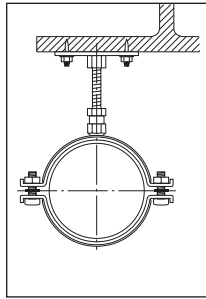

Hanging with threaded couplers

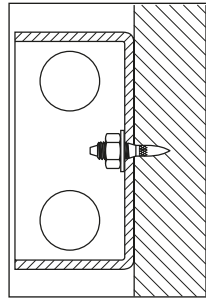

Electrical boxes

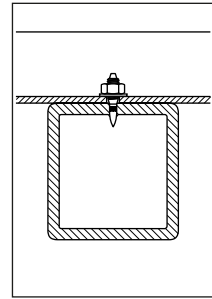

Miscellaneous attachments

Performance data

Recommended resistance under tension load, shear load and under bending moment

Fastener	Shank	Tension load	Shear load	Bending moment
designation	$d_s \times L_s$	N_{rec}	V_{rec}	M_{rec}
X-EM6H, X-EW6H, X-EF7H	3.7 x 8.5 mm	1.6 kN	1.6 kN	5.0 Nm
X-EM8H, X-EM10H	4.5 x 12.0 mm	2.4 kN	2.4 kN	9.0 Nm
X-EW10H-30-14	5.2 x 15.0 mm	3.0 kN	3.0 kN	14.0 Nm

Conditions:

- Redundancy (multiple fastening) must be provided.
- Global factor of safety for static pull-out > 3 (based on 5% fractile value).
- Predominantly static loading.
- Strength of fastened material must be considered.
- Observance of all application limitations and recommendations.
- The recommended loads in the table refer to the resistance of the individual fastening and may not be the same as the loads F_N and F_V acting on the fastened part.

Note: If relevant, prying forces need to be considered in design, see example. Moment acting on fastener shank only in case of a gap between base and fastened material.

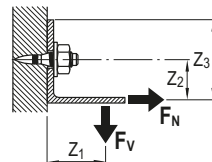
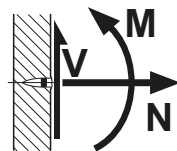

Arrangement to prevent moment on shank

Coupler tight against steel

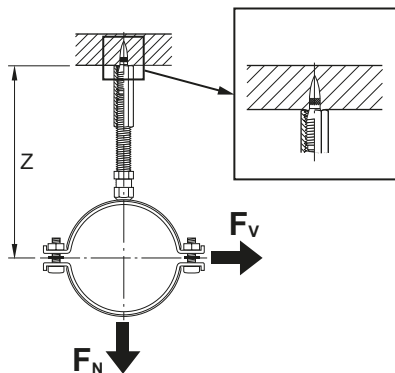

Application recommendation

Base material thickness

Designation	Minimum steel thickness
	t_{li}
X-EM6H/EW6H, X-EF7H	≥ 4 mm
X-EM8H/EW8H, X-EM10H/X-EW10H	≥ 6 mm

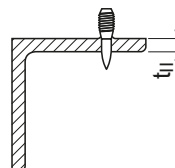

Fastened material thickness

$$t_l \leq L_g - t_{washer} - t_{nut} \approx 1.5-33.0 \text{ mm}$$

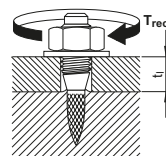

Fastener positioning and base material

Edge distance: $c \geq 15$ mm

Spacing: $s \geq 15$ mm

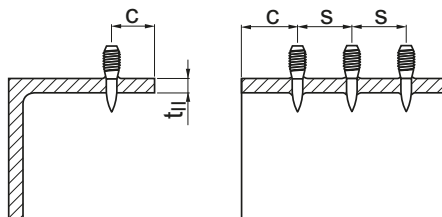

Application recommendation

X-EM6H, X-EW6H, X-EF7H

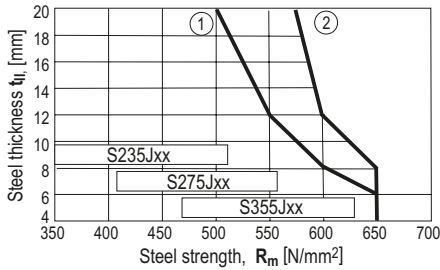

Tool type: DX 6, DX 5, DX 460

- ① X-EF7H-__-9
- ② X-EM6H-__-9,
X-EW6H-__-9

X-EM8H

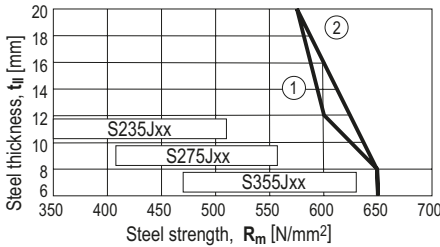

Tool type: DX 6, DX 5, DX 460

- ① X-EM8H-__-12

Tool type: DX 76/DX 76 PTR
with X-76-F10-PTR fastener guide:

- ② X-EM8H-15-12

X-EM10H, X-EW10H

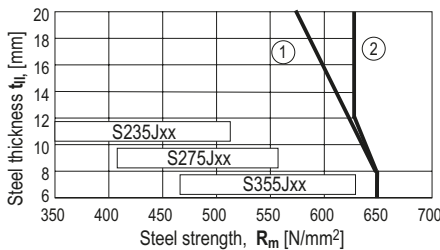

Tool type: DX 76/DX 76 PTR

- ① X-EM10H-24-12

Tool type: DX 600 N

- ② X-EW10H-30-14 P10

System recommendation

- For more details, please refer to the chapter **Accessories and consumables compatibility** in the Direct Fastening Technology Manual (DFTM).

Cartridge recommendation for X-EM6H, X-EW6H

Base material		Cartridge color (tool power level)	
		Tool type: DX 6 F8	Tool type: DX 5 F8, DX 460 F8
		Cartridge type: 6.8/11 M	Cartridge type: 6.8/11 M
S235	$4 \leq t_{II} \leq 10 \text{ mm}$	titanium ■ (1-3)	green ■
	$10 < t_{II} \leq 20 \text{ mm}$	titanium ■ (2-5)	yellow ■
S275	$4 \leq t_{II} \leq 6 \text{ mm}$	titanium ■ (1-3)	green ■
	$6 < t_{II} \leq 20 \text{ mm}$	titanium ■ (2-5)	yellow ■
S355	$4 \leq t_{II} \leq 20 \text{ mm}$	titanium ■ (2-5)	yellow ■

Cartridge recommendation for X-EF7H

Base material		Cartridge color (tool power level)	
		Tool type: DX 6 F8	Tool type: DX 5 F8, DX 460 F8
		Cartridge type: 6.8/11 M	Cartridge type: 6.8/11 M
S235	$4 \leq t_{II} \leq 8 \text{ mm}$	titanium ■ (1-3)	green ■
	$8 < t_{II} \leq 20 \text{ mm}$	titanium ■ (2-5)	yellow ■
S275	$4 \leq t_{II} \leq 6 \text{ mm}$	titanium ■ (1-3)	green ■
	$6 < t_{II} \leq 20 \text{ mm}$	titanium ■ (2-5)	yellow ■
S355	$4 \leq t_{II} \leq 20 \text{ mm}$	titanium ■ (2-5)	yellow ■

Cartridge recommendation for X-EM8H

Base material		Cartridge color (tool power level)	
		Tool type: DX 6 F8	Tool type: DX 5 F8, DX 460 F8
		Cartridge type: 6.8/11 M	Cartridge type: 6.8/11 M
S235, S275	$6 \leq t_{II} \leq 8 \text{ mm}$	titanium ■ (5-8), black ■ (6-8)	red ■, black ■
S235, S275	$8 \leq t_{II} \leq 20 \text{ mm}$	titanium ■ (7-8), black ■ (6-8)	black ■
S355	$6 \leq t_{II} \leq 20 \text{ mm}$	titanium ■ (7-8), black ■ (6-8)	black ■

Cartridge recommendation for X-EM8H

Base material		Cartridge color (tool power level)
		Tool type: DX 76 PTR
		Cartridge type: 6.8/18 M
S235	$4 \leq t_{ } \leq 8 \text{ mm}$	blue ■
	$8 < t_{ } \leq 20 \text{ mm}$	red ■
S275	$6 \leq t_{ } \leq 7 \text{ mm}$	blue ■
	$7 < t_{ } \leq 8 \text{ mm}$	red ■
	$8 < t_{ } \leq 20 \text{ mm}$	black ■
S355	$6 \leq t_{ } \leq 8 \text{ mm}$	red ■
	$8 < t_{ } \leq 20 \text{ mm}$	black ■

Cartridge recommendation for X-EM10H

Base material		Cartridge color (tool power level)
		Tool type: DX 76 PTR
		Cartridge type: 6.8/18 M
S235	$6 \leq t_{ } \leq 20 \text{ mm}$	yellow ■
S275	$6 \leq t_{ } \leq 7 \text{ mm}$	yellow ■
	$7 < t_{ } \leq 8 \text{ mm}$	blue ■
	$8 < t_{ } \leq 20 \text{ mm}$	red ■
S355	$6 \leq t_{ } \leq 8 \text{ mm}$	red ■
	$8 < t_{ } \leq 20 \text{ mm}$	black ■

Cartridge recommendation for X-EW10H

Base material		Cartridge color (tool power level)
		Tool type: DX 600 N
		Cartridge type: 6.8/18 M
S235	$6 \leq t_{II} \leq 20 \text{ mm}$	blue ■
	$8 \leq t_{II} \leq 15 \text{ mm}$	red ■
	$15 < t_{II} \leq 20 \text{ mm}$	black ■
S275	$6 \leq t_{II} \leq 8 \text{ mm}$	blue ■
	$8 < t_{II} \leq 12 \text{ mm}$	red ■
	$12 < t_{II} \leq 20 \text{ mm}$	black ■
S355	$6 \leq t_{II} \leq 7 \text{ mm}$	red ■
	$7 < t_{II} \leq 20 \text{ mm}$	black ■

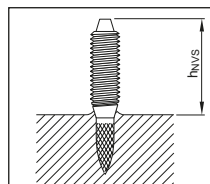

- Tool power level adjustment by setting tests on site.
- Start tool energy selection with lowest recommended tool power level.
- Correct according requirement from chapter quality assurance.

Quality assurance
X-EM6H, X-EW6H, X-EF7H

Nail standoff

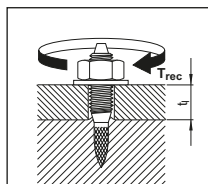

Tightening torque

Fastener	h_{NVS} [mm]	T_{rec} [Nm]
X-EM6H-8-9	8.0–11.0	≤ 4
X-EM6H-/X-EW6H-11-9	9.5–12.5	≤ 4
X-EM6H-/X-EW6H-20-9	18.5–21.5	≤ 4
X-EW6H-28-9	26.5–29.5	≤ 4
X-EW6H-38-9	36.5–39.5	≤ 4
X-EF7H-7-9	9.0–12.0	≤ 4

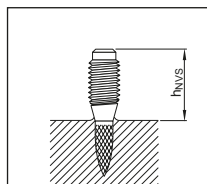
X-EM8H, X-EM10H, X-EW10H

Nail standoff

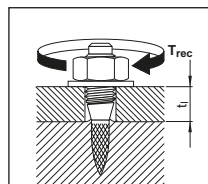

Tightening torque

Fastener	h_{NVS} [mm]	T_{rec} [Nm]
X-EM8H-11-12	11.5–15.5	≤ 10.5
X-EM8H-15-12	15.5–19.5	≤ 10.5
X-EM10H-24-12	26.5–29.5	≤ 10.5
X-EW10H-30-14	28.0–31.0	≤ 15.0

Fastener program

Base material thickness $t_{l,min}$	Fastened thickness $t_{l,max}$	Fastener Designation	Item no.	Threading length L_g	Shank lengths L_s	DX tools
4.0 mm	1.5 mm	X-EM6H-8-9 FP8	271965	8 mm	8.5 mm	DX 6, DX 5, DX 460,
4.0 mm	4.5 mm	X-EM6H-11-9 FP8	271963	11 mm	8.5 mm	DX 6, DX 5, DX 460,
4.0 mm	13.5 mm	X-EM6H-20-9 FP8	271961	20 mm	8.5 mm	DX 6, DX 5, DX 460,
4.0 mm	4.5 mm	X-EW6H-11-9 FP8	271973	11 mm	8.5 mm	DX 6, DX 5, DX 460,
4.0 mm	13.5 mm	X-EW6H-20-9 FP8	271971	20 mm	8.5 mm	DX 6, DX 5, DX 460,
4.0 mm	21.5 mm	X-EW6H-28-9 FP8	271969	28 mm	8.5 mm	DX 6, DX 5, DX 460,
4.0 mm	31.5 mm	X-EW6H-38-9 FP8	271967	38 mm	8.5 mm	DX 6, DX 5, DX 460,
4.0 mm	0.5 mm	X-EF7H-7-9 FS8	271975	7 mm	10 mm	DX 6, DX 5, DX 460,
6.0 mm	2.0 mm	X-EM8H-11-12 P8	271983	11 mm	12 mm	DX 6, DX 5, DX 460,
6.0 mm	6.0 mm	X-EM8H-15-12 P8	271981	15 mm	12 mm	DX 6, DX 5, DX 460,
6.0 mm	6.0 mm	X-EM8H-15-12 FP10	271982	15 mm	12 mm	DX 6, DX 5, DX 460, DX 76 PTR,
6.0 mm	14.0 mm	X-EM10H-24-12 P10	271984	24 mm	12 mm	DX 6, DX 5, DX 460, DX 76 PTR,
6.0 mm	20.0 mm	X-EW10H-30-14 P10	271985	30 mm	14 mm	DX 600 N



- Fastener designation – Type of threading:
M = metric; W6, W10 = Whitworth $\frac{1}{4}$ " ; $\frac{3}{8}$ " ; F7 = French 7 mm

X-BT Stainless steel threaded stud

Product data

Dimensions

X-BT W10-24-6 SN12-R
X-BT M10-24-6 SN12-R

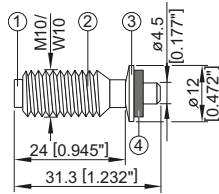

X-BT M8-15-6 SN12-R

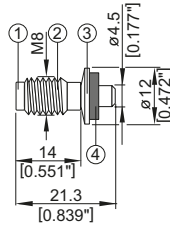

X-BT W6-24-6 SN12-R
X-BT M6-24-6 SN12-R

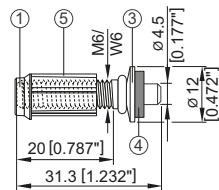

Material specifications

① Shank:

CR 500 (CrNiMo alloy) equivalent to A4 /
S31803 (1.4462) AISI grade 316 material
N 08926 (1.4529) ¹ Available on request

② Threaded sleeve: S31609

(X5CrNiMo 17-12-2+2H, 1.4401)

③ SN12-R washers: S 31635

(X2CrNiMo 17-12-2, 1.4404)

④ Sealing washers: Chloroprene rubber CR

3.1107, black* Resistant to UV, salt water, water, ozone, oils, etc.

¹⁾ For High Corrosion Resistance HCR material inquire at Hilti

Designation according to Unified Numbering System (UNS)

Recommended fastening tools

BX 3-BT / BTG

DX 351-BT / BTG

- For more details, please refer to **X-BT fastener program** and to the chapter **Accessories and consumables compatibility** in the Direct Fastening Technology Manual (DFTM).

Approvals and certificates

ICC ESR-2347 (USA), ABS, LR, DNV-GL,

BV 23498/B0, GL 12272-10HH, Russian Maritime Register

- Not all information presented in this product data sheet might be subject to approval/certificate content. Please refer to approval/certificate for further information.

Applications

Examples

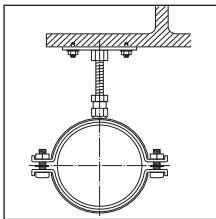
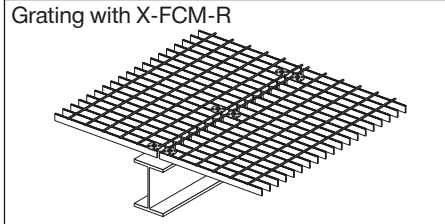
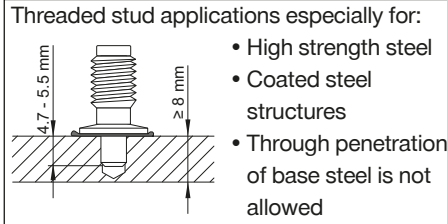

Base plates

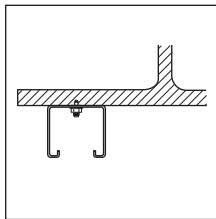

Installation rails

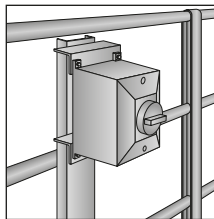

Junction box, etc.

Performance data

Recommended loads – Steel

Steel grade: Europe, USA	S235, A36	S355, Grade 50 and stronger steel
Tension, N_{rec} [kN/lb]	1.8 / 405	2.3 / 517
Shear, V_{rec} [kN/lb]	2.6 / 584	3.4 / 764
Moment, M_{rec} [Nm/lbft]	8.2 / 6	8.2 / 6
Torque, T_{rec} [Nm/lbft]	8 / 5.9	8 / 5.9

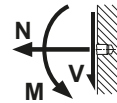

Example:

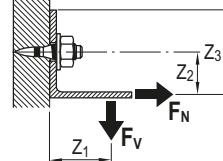

Recommended loads – cast iron *

Tension, N_{rec} [kN/lb]	0.5 / 115
Shear, V_{rec} [kN/lb]	0.75 / 170
Moment, M_{rec} [Nm/lbft]	8.2 / 6

Conditions for recommended loads:

- Global factor of safety for static pull-out > 3 (based on 5% fractile value)
 - Minimum edge distance = 6 mm [$1/4"$].
 - Effect of base metal vibration and stress considered.
 - Redundancy (multiple fastening) must be provided.
 - The recommended loads in the table refer to the resistance of the individual fastening and may not be the same as the loads FN and FV acting on the fastened part.
- Note: If relevant, prying forces need to be considered in design, see example. Moment acting on fastener shank only in case of a gap between base and fastened material.

Design resistance – steel			
Steel grade:			
Europe		S235	S355
Tension	N_{Rd} [kN]	2.9	3.7
Shear	V_{Rd} [kN]	4.2	5.4
Moment	M_{Rd} [Nm]	18.4	18.4

Design resistance – cast iron *			
Tension	N_{RD} [kN]	0.8	
Shear	V_{RD} [kN]	1.2	
Moment	M_{RD} [Nm]	13.1	

*Requirements of spheroidal graphite cast iron base material

Subject	Requirements
Cast iron	Spheroidal graphite cast iron according to EN 1563
Strength class	EN-GJS-400 to EN-GJS-600 according to EN 1563
Chemical analysis and amount of carbon	3.3–4.0 mass percentage
Microstructure	Form IV to VI (spherical) according to EN ISO 945-1:2010 Minimum size 7 according to Figure 4 of EN ISO 945-1:2010
Material thickness	$t_{ } \geq 20$ mm

Recommended interaction formula for combined loading

Combined loading situation	Interaction formula
V–N (shear and tension)	$\frac{V}{V_{rec}} + \frac{N}{N_{rec}} \leq 1.2$ with $\frac{V}{V_{rec}} \leq 1.0$ and $\frac{N}{N_{rec}} \leq 1.0$
V–M (shear and bending)	$\frac{V}{V_{rec}} + \frac{M}{M_{rec}} \leq 1.2$ with $\frac{V}{V_{rec}} \leq 1.0$ and $\frac{M}{M_{rec}} \leq 1.0$
N–M (tension and bending)	$\frac{N}{N_{rec}} + \frac{M}{M_{rec}} \leq 1.0$
V–N–M (shear, tension and bending)	$\frac{V}{V_{rec}} + \frac{N}{N_{rec}} + \frac{M}{M_{rec}} \leq 1.0$

Cyclic loading:

- Anchorage of **X-BT-R** threaded stud in steel base material is not affected by cyclic loading.
- Fatigue strength is governed by fracture of the shank. Inquire at Hilti for test data if high cycle loading has to be considered in the design.

Application recommendation

Thickness of base material

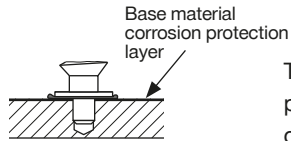
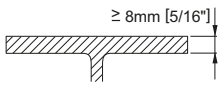

Thickness of base material corrosion protection layer $\leq 0.4\text{mm}$. For thicker coatings, please contact Hilti.

Thickness of fastened material

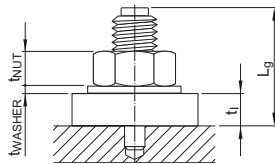

X-BT M8:	$2.0 \leq t_1 \leq 7.0\text{ mm}$
X-BT M10 / X-BT W10:	$2.0 \leq t_1 \leq 15.0\text{ mm}$
X-BT M6 / X-BT W6:	$1.0 \leq t_1 \leq 14.0\text{ mm}$

Note:

For X-BT with SN 12R sealing washer $t_1 \geq 2.0\text{ mm}$

For X-BT M6 / W6 with SN 12R sealing washer $t_1 \geq 1.0\text{ mm}$

Spacing and edge distances

Edge distance: $\geq 6\text{ mm}$

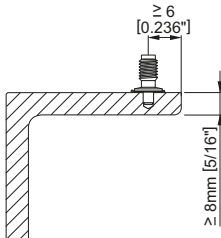

Spacing: $\geq 15\text{ mm}$

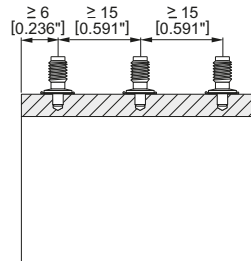

Application limit

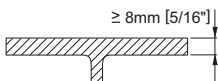

- $t_{II} \geq 8\text{ mm}$ [5/16"] \rightarrow No through penetration
- No limits with regards to steel strength

Corrosion information

The corrosion resistance of Hilti CR500 and S31803 (1.4462) stainless steel material is equivalent to AISI 316 (A4) steel grade.

Studs made of N 08926 (HCR) material with higher corrosion resistance, e.g. for use in road tunnels or swimming pools, are available on special order.

Fastener program and system recommendation

Fastener program

Fastener designation	Item no.	Tool Designation
X-BT M8-15-6 SN12-R	377074	BX 3-BTG, DX 351-BTG
X-BT M10-24-6 SN12-R	377078	BX 3-BT, DX 351-BT
X-BT W10-24-6 SN12-R	377076	BX 3-BT, DX 351-BT
X-BT W10 without washer	377075	BX 3-BT, DX 351-BT
X-BT M6-24-6 SN12-R	432266	BX 3-BT, DX 351-BT
X-BT W6-24-6 SN12-R	432267	BX 3-BT, DX 351-BT

Note: For High Corrosion Resistance HCR material inquire at Hilti

Cartridge recommendation

6.8/11 M high precision brown cartridge



- Tool power level adjustment by setting tests on site.
- Correct according requirement from chapter quality assurance.

Quality assurance

Fastening inspection

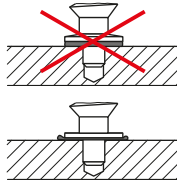
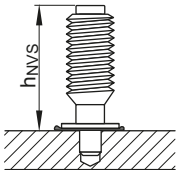

X-BT M8
 $h_{NVS} = 15.7-16.8 \text{ mm}$

X-BT M10 / X-BT W10 and
 X-BT M6 / X-BT W6
 $h_{NVS} = 25.7-26.8 \text{ mm}$

Installation

X-BT with washer

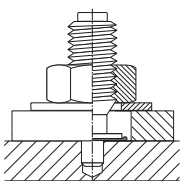

Fastened material hole \varnothing
 $\geq 13 \text{ mm}$

X-BT M6 / X-BT W6

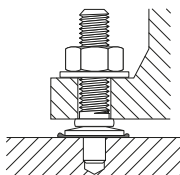

Fastened material with
 pre-drilled hole diameter
 $< 7 \text{ mm}$

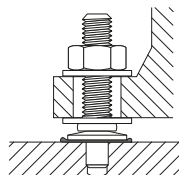

Fastened material with
 pre-drilled hole diameter
 $\geq 7 \text{ mm}$

Pre-drill with TX-BT 4/7 step shank drill bit

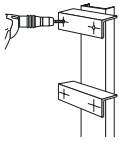

Pre-drill until the shoulder grinds a shiny ring (to ensure proper drilling depth)



Before fastener installation:
the drilled hole must be clear of liquids and debris.
The area around the drilled hole must be free from liquids and debris.

Tighten using a screwdriver with torque clutch

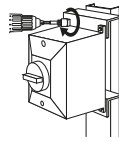

Tightening torque:
 $T_{rec} \leq 8 \text{ Nm (5.9 ft-lb)}$

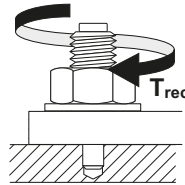

Hilti Torque tool X-BT 1/4"

Hilti screwdriver:	Torque setting:
SF 121-A	11
SF 150-A	9
SF 180-A	8
SF 144-A	9
SF 22A	9
SFC 22-A	5
SBT 4-A22	5

These are abbreviated instructions which may vary by application.
ALWAYS review/follow the instructions accompanying the product.

X-BT New Generation stainless steel threaded stud

Product data

Dimensions

X-BT-MR M10/15 SN 8
X-BT-MR W10/15 SN 8

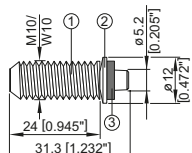

X-BT-MR M8/14 SN 8

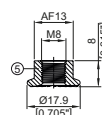
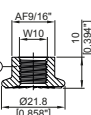
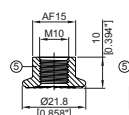
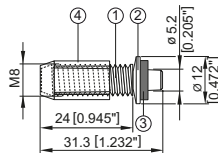

X-BT-MR M6/10 SN 8
X-BT-MR W6/10 SN 8

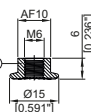
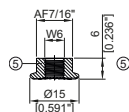
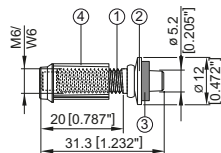

X-BT-GR M8/7 SN 8

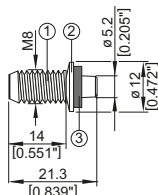

Features and benefits

The X-BT system is an approved Fastening on Steel system for grating and multi-purpose fastening applications. Benefits include no-rework to backside of base material, not having application limits and capability to work in C5 corrosive environment. The new generation X-BT system has increased load performance compared with the previous X-BT.

Material specifications

- ① Shank and thread: S31803 (1.4462)
equivalent to A4 / AISI grade 316 material
 - ② SN washer: S 31635
(X2CrNiMo 17-12-2, 1.4404)
 - ③ Sealing washer: Elastomer, black, resistant to UV, salt water, water, ozone, oils, etc.
 - ④ Guiding sleeve: Plastic
 - ⑤ Flange nut: A4 / AISI grade 316 material
- Designation according to Unified Numbering System (UNS)

Recommended fastening tools

BX 3-BT / BTG
DX 351-BT / BTG

- For more details, please refer to **X-BT-GR/-MR fastener program** and to the chapter **Accessories and consumables compatibility** in the Direct Fastening Technology Manual (DFTM).

Approvals and certificates

ABS: 18-HS1755518, DNV-GL TAS00001SV, BV 54554, LR 19/0003, ICC-ES ESR-2347 (USA)

- Not all information presented in this product data sheet might be subject to approval/certificate content. Please refer to approval/certificate for further information.

Applications

Examples

Threaded stud applications especially for:

- High strength steel
- Coated steel structures
- Through penetration of base steel is not allowed

* Grating with X-BT-GR and X-FCM-R (HL)

* Load data, application requirements, corrosion information, fastener selection, system recommendation, material specification and coating refer to section X-FCM-R, X-FCM-R HL or X-FCS-R Grating Fastening System in the Direct Fastening Technology Manual

Multi purpose fastening with X-BT-MR

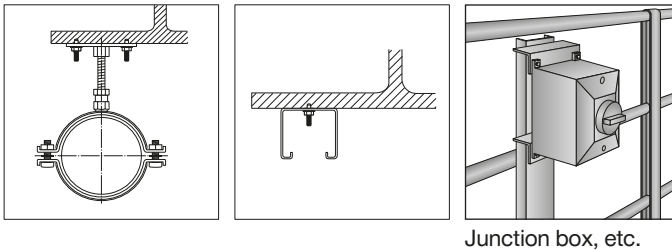

Junction box, etc.

Performance data – Construction steel

Recommended loads – steel base material

Steel grade: Europe, USA	S235, S275 A36	S355 to S960 ≥ Grade 50
Tension, N_{rec} [kN/lb]	3.6 / 810	4.6 / 1030
Shear –		
form lock V_{rec} [kN/lb]	4.3 / 970	5.3 / 1190
friction lock V_{rec} [kN/lb]	0.20 / 45	0.20 / 45
Moment, M_{rec} [Nm/lbft]	20.0 / 14.8	20.0 / 14.8
Torque, T_{rec} [Nm/lbft]	20.0 / 14.8	20.0 / 14.8

Example:

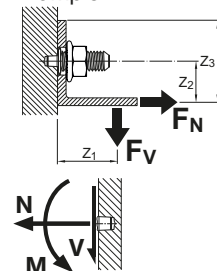

Conditions for recommended loads:

- Application of working load design concept (e.g. ASD)
- For unalloyed construction, off-shore and Shipbuilding steel: e.g. European grades S235, S275, S355 according to EN 10025-2, S355M, S420M, S460M according to EN 10025-4 or EN 10225, S690Q and S960Q according to EN10025-6, US steel grade A36 and Grade 50.
- Minimum base material thickness $t_{II} = 8$ mm.
- Applicable for steel base materials up to a coating thickness of 500 μm .
- Edge distance $c \geq 10$ mm [$\frac{3}{8}$ "].
- In case of edge distance $6 \text{ mm} \leq c < 10$ mm, N_{rec} , V_{rec} and M_{rec} need to be reduced with the reduction factor $\alpha_c = 0.65$.
- For group fastenings with up to 4 fasteners per group and shear force introduction via the sealing washer, the resistance of all fasteners can be added up, provided the hole in the fastened material is equal or less than 14 mm (e.g. $V_{\text{rec,group}} = 17.2$ kN for a group with 4 fasteners fixed to S235 base material). For more details see “New Generation Hilti X-BT-GR, X-BT-MR and X-BT-ER Threaded Fastener Specification”.
- Redundancy (multiple fastening) must be provided.

Remarks:

- The recommended loads in the table refer to the resistance of the single fastener and need to be determined by static analysis from the loads F_N and F_V acting on the fastened part. Typical example is the need of consideration of prying forces, see example.
- Moments acting on the shank only need to be considered in case of a gap between the base and the fastened material.
- Global factor of safety for tension and shear load = 2.8 related to the characteristic resistance N_{Rk} and V_{Rk}
- Global factor of safety for bending moment = 1.75 related to the characteristic bending moment $M_{R,k}$ of the shank.
- Effects of base metal vibration and stresses are considered.
- For difference of form and friction lock for shear resistance, refer to explanations at the end of this data sheet.

Characteristic resistance – steel base material

Steel grade: Europe, USA	S235, S275, A36	S355 to S960, ≥ Grade 50
Tension N_{Rk} [kN/lb]	10.0 / 2240	13.0 / 2920
Shear –		
form lock V_{Rk} [kN/lb]	12.0 / 2700	15.0 / 3360
friction lock V_{Rk} [kN/lb]	0.56 / 125	0.55 / 125
Moment M_{Rk} [Nm/lbft]	35.0 / 25.5	35.0 / 25.5

Design resistance – steel base material

Steel grade: Europe, USA	S235, S275, A36	S355 to S960, ≥ Grade 50
Tension N_{Rd} [kN/lb]	5.0 / 1120	6.5 / 1460
Shear –		
form lock V_{Rd} [kN/lb]	6.0 / 1350	7.5 / 1680
friction lock V_{Rd} [kN/lb]	0.28 / 62	0.28 / 62
Moment M_{Rd} [Nm/lbft]	28.0 / 20.5	28.0 / 20.5

Performance data – Cast iron
Recommended loads – cast iron *

Tension, N_{rec} [kN/lb]	1.0 / 230
Shear –	
form lock V_{rec} [kN/lb]	1.5 / 340
friction lock V_{rec} [kN/lb]	0.20 / 45
Moment, M_{rec} [Nm/lbft]	16.0 / 11.5

Design resistance – cast iron *

Tension N_{Rd} [kN/lb]	1.6 / 360
Shear	
form lock V_{Rd} [kN/lb]	2.4 / 540
friction lock V_{Rd} [kN/lb]	0.28 / 62
Moment M_{Rd} [Nm/lbft]	26.0 / 19.0

***Requirements of spheroidal graphite cast iron base material**

Subject	Requirements
Cast iron	Spheroidal graphite cast iron according to EN 1563
Strength class	EN-GJS-400 to EN-GJS-600 according to EN 1563
Chemical analysis and amount of carbon	3.3 – 4.0 mass percentage
Microstructure	Form IV to VI (spherical) according to EN ISO 945-1:2010 Minimum size 7 according to Figure 4 of EN ISO 945-1:2010
Material thickness	$t_{II} \geq 20$ mm

Recommended interaction formula for combined loading - steel and cast iron base material

Load combination	Interaction provision
V-N (shear and tension)	$\frac{V_{Sd}}{V_{Rd}} + \frac{N_{Sd}}{N_{Rd}} \leq 1.2$ with $\frac{V_{Sd}}{V_{Rd}} \leq 1.0$ and $\frac{N_{Sd}}{N_{Rd}} \leq 1.0$
V-M (shear and bending)	$\frac{V_{Sd}}{V_{Rd}} + \frac{M_{Sd}}{M_{Rd}} \leq 1.2$ with $\frac{V_{Sd}}{V_{Rd}} \leq 1.0$ and $\frac{M_{Sd}}{M_{Rd}} \leq 1.0$
N-M (tension and bending)	$\frac{N_{Sd}}{N_{Rd}} + \frac{M_{Sd}}{M_{Rd}} \leq 1.0$
V-N-M (shear, tension and bending)	$\frac{V_{Sd}}{V_{Rd}} + \frac{N_{Sd}}{N_{Rd}} + \frac{M_{Sd}}{M_{Rd}} \leq 1.0$

Cyclic loading:

- Anchorage of X-BT threaded stud in steel base material is not affected by cyclic loading.
- Fatigue strength is governed by fracture of the shank. For more details see "New Generation Hilti X-BT-GR, X-BT-MR and X-BT-ER Threaded Fastener Specification".

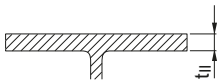
Application recommendation
Application limit and thickness of base material

$t_{II} \geq 8 \text{ mm [5/16"]} \rightarrow$ No through-penetration.
No limits with regard to steel strength.

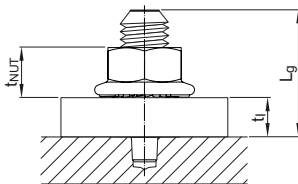
Thickness of fastened material

X-BT-GR M8:	$2.0 \leq t_{II} \leq 7.0 \text{ mm}$
X-BT-MR M10/W10:	$2.0 \leq t_{II} \leq 15.0 \text{ mm}$
X-BT-MR M8:	$2.0 \leq t_{II} \leq 14.0 \text{ mm}$
X-BT-MR M6/W6:	$2.0 \leq t_{II} \leq 10.0 \text{ mm}^*$

* if base material sits on the collar of the stud $t_{II, \min} = 1.0 \text{ mm}$

Spacing and edge distances
Edge distance:

$c \geq 10 \text{ mm}$ (load reduction factor $\alpha_c = 1.00$)

$6 \text{ mm} \leq c < 10 \text{ mm}$ (load reduction factor $\alpha_c = 0.65$)

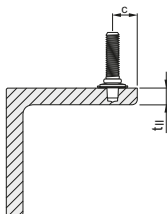
Spacing:

$s \geq 15 \text{ mm}$

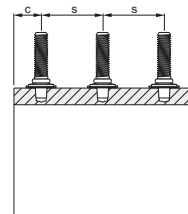

Corrosion information

The corrosion resistance of S31803 (1.4462) stainless steel material is equivalent to AISI 316 (A4) steel grade. For detailed information see “New Generation Hilti X-BT-GR, X-BT-MR and X-BT-ER Threaded Fastener Specification”.

Fastener program and system recommendation

Fastener program

Designation	Item no.	Tool Designation
X-BT-GR M8/7 SN 8	2194344	BX 3-BTG, DX 351-BTG
X-BT-MR M6/10 SN 8	2252199	BX 3-BT, DX 351-BT
X-BT-MR M6/14 SN8	2194337	DX 351-BT
X-BT-MR W6/10 SN 8	2252470	BX 3-BT, DX 351-BT
X-BT-MR W6/14 SN 8	2194338	DX 351-BT
X-BT-MR M8/14 SN 8	2194339	BX 3-BT, DX 351-BT
X-BT-MR M10/15 SN 8	2194340	BX 3-BT, DX 351-BT
X-BT-MR W10/15 SN 8	2194341	BX 3-BT, DX 351-BT

Cartridge selection and tool energy setting

DX 351-BTG, DX 351-BT: 6.8/11 M high precision brown cartridge

Battery selection and fastener guide adjustment

BX 3-BT, BX 3-BTG: 22 V cordless tool battery platform

Battery recommendation: B 22/2.6, also allowed B 22/3.0, B 22/4.0, B 22/5.2

The recommended fastener guide position is “1” (if required, adjust the fastener guide position based on job site tests and IFU).

Quality assurance

Fastening inspection

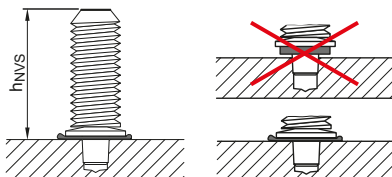

X-BT-GR M8
 $h_{NVS} = 15.7\text{--}16.8\text{ mm}$

X-BT-MR M6/W6/M8/M10/W10
 $h_{NVS} = 25.7\text{--}26.8\text{ mm}$

Installation recommendation
X-BT-MR M8

Fastened material:

- Hole diameter: 13 to 14 mm: Use of supplied flange nut ①
- Hole diameter: beyond 14 to 18 mm: Use of supplied flange nut with supplement washer (maximum thickness of fixed component to be reduced with thickness of washer) ②

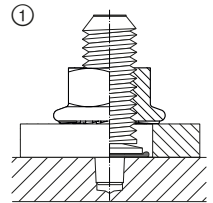
X-BT-MR M10/W10

Fastened material:

- Hole diameter: 13 to 18 mm: Use of supplied flange nut ①
- Hole diameter: beyond 18 to 22 mm: Use of supplied flange nut with supplement washer (maximum thickness of fixed component to be reduced with thickness of washer) ②

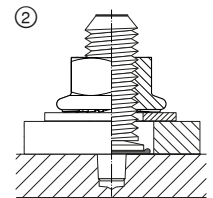
X-BT-MR M6/W6

Fastened material:

- Hole diameter: 6.5 – 6.7: Fastener sits on collar of stud, use of supplied flange nut ③
- Hole diameter: 6.7 to 11 mm: Use of supplied flange nut with supplement washer sitting on collar ④
- Hole diameter: > 12 mm, fixed part sits on base material, use of flange nut with supplemental washer to cover hole clearance (maximum thickness of fixed component to be reduced with thickness of washer) ②

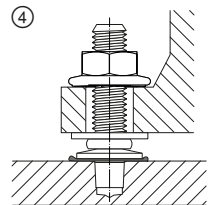
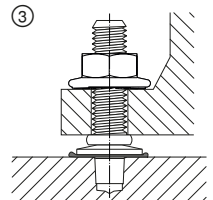
Remarks on group fastenings

For group fastenings with up to 4 fasteners per group and shear force introduction via the sealing washer, the resistance of all fasteners can be added up, provided the hole in the fastened material is equal or less than 14 mm. For detailed information see “New Generation Hilti X-BT-GR, X-BT-MR and X-BT-ER Threaded Fastener Specification”.

Pre-drill

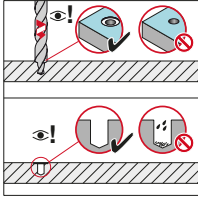
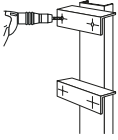

- Pre-drill with TX-BT 4.7/7 step shank drill bit.
- Pre-drill until shoulder grinds a shiny ring.
- The drill hole and the area around drilled hole must be clean and free from liquids and debris.

These are abbreviated instructions which may vary by application.

ALWAYS review/follow the instructions accompanying the product.

Tightening torque

	Fastener: X-BT-GR, X-BT-MR
Element: nut	20 Nm

Tightening tool recommendation for tightening with cordless screwdriver

Cordless screwdriver	Clutch type (stop detection)	Gear	Clutch
SF 6-A22	ESC (HJ)	1	5
SF 6H-A22	ESC (HJ)	1	5
SF 10W-A22	TRC	4	11
SF 8M-A22	TRC	4	11
SFC 14-A	TRC	2	11
SFC 22-A	TRC	2	11



- Tool power level adjustment:

Gear:



Clutch:



- The setting of the torque via the Hilti screwdriver with torque release coupling (TRC) can change as the clutch wears over time. The specified torque setting is only a rough guide value and applies to a new Hilti screwdriver. To ensure recommended torque is applied, Hilti recommends the use of a calibrated torque wrench or the Hilti torque tool.
- The specified torque setting for the Hilti screw drivers with electronic slip clutch (ESC) is only a rough guide value as the ESC has 2 stop detections; Soft Joint (SJ) detection and Hard Joint (HJ) detection. The hard joint detection is activated due to drop in speed (fast stop) and can lead to a torque spike. The installation torque may vary depending on the user and the application. To ensure recommended torque is applied, Hilti recommends the use of a calibrated torque wrench or the Hilti torque tool.

Tightening tool recommendation for tightening with Hilti torque tool

Hilti torque tool

Torque tool X-BT 1/4" – 20 Nm

Form and friction lock for shear connection

Shear load transfer via friction lock is relevant if non-slip connections are required in the service state

- Fixing the position of channel sections with slotted holes and forces in direction of the slots
- Connections with hole clearance beyond 14 mm

Slotted holes or bigger hole clearance allow easier assembly and geometric adjustment of the fixed component. Consequently form lock mechanism by means of direct contact of the fixed component with the washer of the X-BT-MR cannot be easily ensured with little slip in those cases. The New Generation X-BT-MR fasteners allow the use higher torque of 20 Nm resulting in a friction shear connection capacity. That friction lock can be utilized to fix the position of the attached component as well as for shear load transfer if the demand is comparably small. In case of high shear demand, the form lock mechanism has to be activated and can further be optimized for group fastenings (for more details on group fastenings relying on form lock, see „New Generation Hilti X-BT-GR, X-BT-MR and X-BT-ER Threaded Fastener Specification“)

Examples of friction lock

MQ-41 channel with X-BT-MR M10/15 SN 8 and varying distances e_1 and e_2

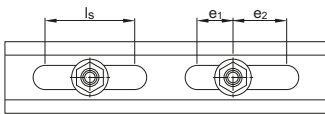

ls ... length of the slot (50 mm)
bs ... width of the slot (14 mm)

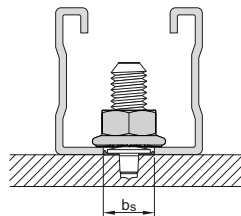

X-BT-MR connections with maximum hole diameter in fixed material

X-BT-MR M8/14 SN 8, max. hole $\varnothing = 18$ mm X-BT-MR M10/15 SN 8, max. hole $\varnothing = 22$ mm

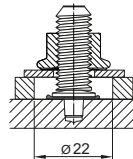
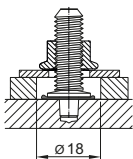

Conditions and remarks

- The use of friction lock connection forces requires the application of an installation torque $T = 20$ Nm.
- Friction lock not suitable in case of base material vibrations.
- The friction lock values are suitable to fix the position of components and in case of lower shear load demand. Full shear load capacity are developed by means of form lock via contact of the fixed component with the sealing washer of the X-BT-MR.

X-BT-MF Composite threaded stud

Product data

Dimensions

X-BT-MF M/W 10/10 SN4

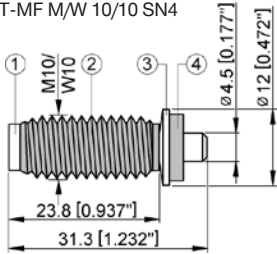

M10 nut

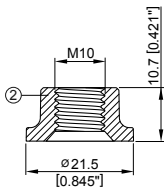

W10 nut

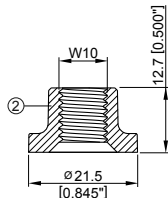

W10 = 3/8" UNC 2 thread

Material specifications

- ① Shank: 1.4362 according to EN 10088-2
- ② Threaded sleeve and nut: ASTM A240 UNS S32304
Glass-fiber reinforced polyamide material - ISO 1874: PA6T/6I, MH, 12-190, GF50 (glass-fiber content: 50%), Flammability rating: UL94 HB
- ③ SN12 washer: S 31635
(X2CrNiMo 17-12-2, 1.4404)
- ④ Sealing washer: Chloroprene rubber CR 3.1107, black

Recommended fastening tools

DX 351-BT

- For more details, please refer to **X-BT-MF fastener program** and to the chapter **Accessories and consumables compatibility** in the Direct Fastening Technology Manual (DFTM).

Approvals and certificates

ICC ESR-2347

- Not all information presented in this product data sheet might be subject to approval/certificate content. Please refer to approval/certificate for further information.

Applications

Examples

Threaded stud applications especially for:

- High strength steel
- Coated steel structures
- Through penetration of base steel is not allowed

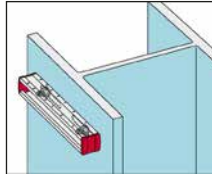
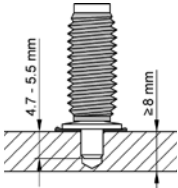

Channel installation

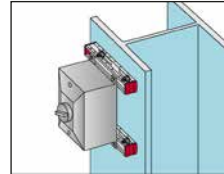

Junction box, etc.

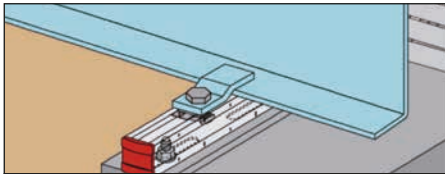

Cable ladder with hold-down/expansion-guide clip

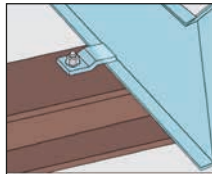

Cable ladders



Signage

Performance data

Recommended loads

For structural steel (ultimate strength of base material $R_m \geq 350$ MPa)

Service temperature		-40°C to +60°C / -40°F to +140°F	+60°C to +100°C / +140°F to 212°F
Tension	N_{rec}	1.5 kN / 340 lb	1.0 kN / 225 lb
Shear	V_{rec}	2.2 kN / 500 lb	1.4 kN / 315 lb
Moment	M_{rec}	8.2 Nm / 6 lbft	8.2 Nm / 6 lbft
Torque	T_{rec}	≤ 8 Nm / ≤ 5.9 lbft	≤ 8 Nm / ≤ 5.9 lbft
During installation			
In service temp. range		-40°C to +100°C / -40°F to +212°F	
Installation temperature		-10°C to +60°C / 14°F to 140°F	

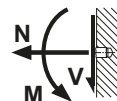

Example:

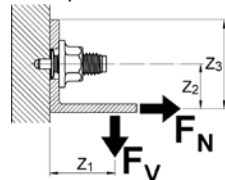

Conditions for recommended loads:

- Use with Hilti glass-fiber reinforced polyamide material nuts, M10 and W10 (② according to General Information - Material specifications)
- Not to be used with any additional washer which provide an axial force when deformed, e.g. spring or lock washer, etc.
- Global factor of safety > 3 (based on 5% fractile value)
- Minimum edge distance = 6 mm [¹/₄"].
- Effect of base metal vibration and stress considered.
- Redundancy (multiple fastening) must be provided.
- The recommended loads in the table refer to the resistance of the individual fastening and may not be the same as the loads F_N and F_V acting on the fastened part.
Note: If relevant, prying forces need to be considered in design, see example. Moment acting on fastener shank only in case of a gap between base and fastened material.
- Minimum temperature for installation and adjustments = -10°C

Design loads

For structural steel (ultimate strength of base material $R_m \geq 350$ MPa)

Service temperature		-40°C to +60°C / -40°F to +140°F	+60°C to +100°C / +140°F to 212°F
Tension	N_{Rd}	2.0 kN / 450 lb	1.35 kN / 300 lb
Shear	V_{Rd}	3.0 kN / 675 lb	1.9 kN / 425 lb
Moment	M_{Rd}	18.4 Nm / 13.6 lbft	18.4 Nm / 13.6 lbft
During installation			
In service temp. range		-40°C to +100°C / -40°F to +212°F	
Installation temperature		-10°C to +60°C / 14°F to 140°F	

Recommended interaction formula for combined loading

Combined loading situation	Interaction formula
V-N (shear and tension)	$\frac{V}{V_{rec}} + \frac{N}{N_{rec}} \leq 1.2$ with $\frac{V}{V_{rec}} \leq 1.0$ and $\frac{N}{N_{rec}} \leq 1.0$
V-M (shear and bending)	$\frac{V}{V_{rec}} + \frac{M}{M_{rec}} \leq 1.2$ with $\frac{V}{V_{rec}} \leq 1.0$ and $\frac{M}{M_{rec}} \leq 1.0$
N-M (tension and bending)	$\frac{N}{N_{rec}} + \frac{M}{M_{rec}} \leq 1.0$
V-N-M (shear, tension and bending)	$\frac{V}{V_{rec}} + \frac{N}{N_{rec}} + \frac{M}{M_{rec}} \leq 1.0$

Cyclic loading

- Anchorage of X-BT-MF threaded stud in steel base material is not affected by cyclic loading.
- Fatigue strength is governed by fracture of the shank. Inquire at Hilti for test data if high cycle loading has to be considered in the design.

Application recommendation

Thickness of base material

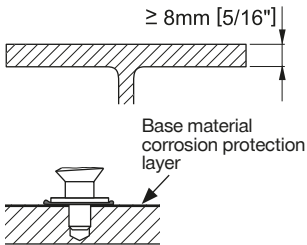

Where through penetration is not allowed*
 Thickness of base material corrosion protection layer
 $\leq 0.4\text{mm}$. For thicker coatings, please contact Hilti.

*Note: Corrosion protection may be compromised if base material thickness is less than 8mm.

Please contact Hilti for load recommendations if base material thickness is less than 8mm and through penetration allowed.

Thickness of fastened material

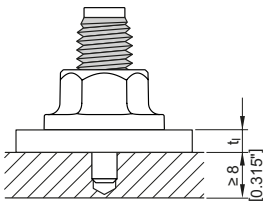

$$2.0 \leq t_f \leq 10.0 \text{ mm}$$

$$0.08" \leq t_f \leq 0.39"$$

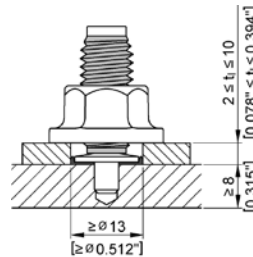

Fastened material hole ϕ
 $\geq 13\text{mm}$ (0.51")

Spacing and edge distances

Edge distance: $\geq 6 \text{ mm}$

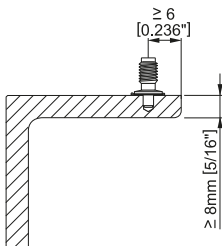

Spacing: $\geq 15 \text{ mm}$

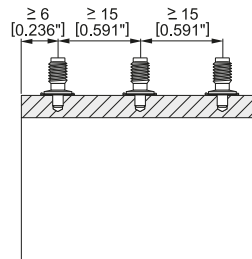

Application limit

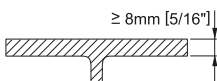

- $t_{II} \geq 8 \text{ mm}$ [$5/16$] → No through penetration
- No limits with regards to steel strength

Durability

From a durability point of view, it can be assumed that the Hilti X-BT-MF system will have a lifetime over 20 years even in mildly corrosive environment (C3 environment according to EN-ISO 12944-2).

Corrosion information

For fastenings exposed to outdoor environments in mildly corrosive conditions where HDG coated parts are commonly specified or used.

Not for use in atmospheres with chlorides (marine atmospheres) or in heavily polluted environments (e.g. sulphur dioxide).

Vibration (Transportation, handling and base material vibration)

When installed according to instruction for use and fastening quality assurance, the X-BT-MF system (stud and Hilti glass-fiber reinforced polyamide material nuts) is resistant to transportation, handling and base material vibration.

The use of additional lock washer is not required. Lock washer will affect the integrity and functionality of the Hilti glass-fiber reinforced polyamide material nuts. Therefore additional lock or spring washers must not be used in combination with the X-BT-MF system. For more information regarding vibration, please refer to “X-BT-MF Additional Technical Information”.

Fastener program and system recommendation

Fastener program

Designation	Item no.	Tool designation
X-BT-MF M10/10 SN4	2083549	DX 351-BT
X-BT-MF W10/10 SN4	2083620	DX 351-BT

Accessories

Designation	Item no.	For use with
Socket X-NSD 1/4" – 16mm	2097397	X-BT-MF M10/10 SN4 and T-handle or Torque tool
Socket X-NSD 1/4" – 9/16"	2107229	X-BT-MF W10/10 SN4 and T-handle or Torque tool
T-handle X-NSD 1/4"	2115130	X-NSD sockets
Torque tool X-BT 1/4"	2119272	X-NSD sockets

Cartridge selection and tool energy setting

6.8/11 M high precision brown cartridge

-  • Tool power level adjustment by setting tests on site.
- Start tool energy selection with lowest recommended tool power level.
- Correct according requirement from chapter quality assurance.

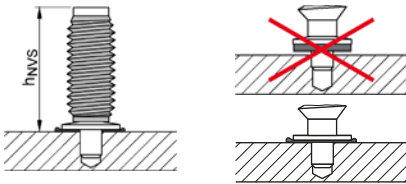
Quality assurance
Fastening inspection

X-BT-MF

$$h_{NVS} = 25.7-26.8 \text{ mm}$$

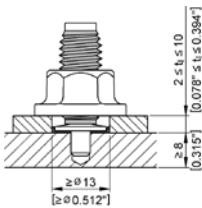
$$= 1.012"-1.055"$$

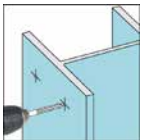
Installation recommendation

Fastened material hole
 $\text{Ø} \geq 13 \text{ mm (0.51")}$
Remark: for group fastenings subjected to shear loading the fastened material hole diameter should not exceed 14mm

Pre-drill

- Pre-drill with TX-BT 4/7 step shank drill bit.
- Pre-drill until the shoulder grinds a shiny ring (to ensure proper drilling depth).
- Before fastener installation: the drilled hole and the area around the drilled hole must be clear of liquids and debris.

These are abbreviated instructions which may vary by application.

ALWAYS review/follow the instructions accompanying the product.

Tightening torque

	Fastener: X-BT-MF
Element: nut	8 Nm

Tightening tool recommendation for tightening with cordless screwdriver

Cordless screwdriver	Clutch type (stop detection)	Gear	Clutch
SF 4-A22	TRC	1	8
SF 6-A22	ESC (HJ)	1	3
SF 6H-A22	ESC (HJ)	1	3
SFC 14-A	TRC	1	6
SFC 18-A	TRC	1	3
SFC 22-A	TRC	1	5
SBT 4-A22	TRC	1	7



- Tool power level adjustment:

Gear:



Clutch:



- The setting of the torque via the Hilti screwdriver with torque release coupling (TRC) can change as the clutch wears over time. The specified torque setting is only a rough guide value and applies to a new Hilti screwdriver. To ensure recommended torque is applied, Hilti recommends the use of a calibrated torque wrench or the Hilti torque tool.
- The specified torque setting for the Hilti screw drivers with electronic slip clutch (ESC) is only a rough guide value as the ESC has 2 stop detections; Soft Joint (SJ) detection and Hard Joint (HJ) detection. The hard joint detection is activated due to drop in speed (fast stop) and can lead to a torque spike. The installation torque may vary depending on the user and the application. To ensure recommended torque is applied, Hilti recommends the use of a calibrated torque wrench or the Hilti torque tool.

Tightening tool recommendation for tightening with Hilti torque tool

Hilti torque tool

Torque tool X-BT 1/4" – 8 Nm

X-BT-MR-N Stainless steel threaded stud for narrow through hole

Product data

Dimensions

X-BT-MR-N M8/14 N 4

X-BT-MR-N M8/4 N 4

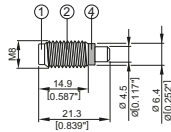
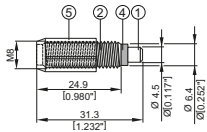

Note on drill-bit:

X-BT-MR-N requires the use of the specific drill bit TX-BT 4/5.5. The drill bit TX-BT 4/7, which is used for X-BT, X-BT-MF and X-BT-ER fasteners must not be used for X-BT-MR-N studs.

Material specifications

① Shank:

CR 500 (CrNiMo alloy) equivalent to A4 / S31803 (1.4462) AISI grade 316 material
N 08926 (1.4529) ¹⁾ Available on request

② Threaded sleeve: S31609

(X5CrNiMo 17-12-2+2H, 1.4401)

④ Sealing washers: Chloroprene rubber CR 3.1107, black*

⑤ Guide sleeve: Plastic

* Resistant to UV, salt water, water, ozone, oils, etc.

¹⁾ For High Corrosion Resistance HCR material inquire at Hilti

Designation according to Unified Numbering System (UNS)

Recommended fastening tools

DX 351-BT / BTG



- For more details, please refer to **X-BT-MR-N fastener program** and to the chapter **Accessories and consumables compatibility** in the Direct Fastening Technology Manual (DFTM).

Approvals and certificates

ABS, LR, DNV-GL, BV



- Not all information presented in this product data sheet might be subject to approval/certificate content. Please refer to approval/certificate for further information.

Applications

Examples

Threaded stud applications especially for:

- High strength steel
- Coated steel structures
- Through penetration of base steel is not allowed

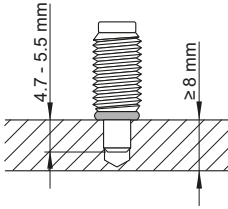

Performance data

Recommended loads – steel

Steel grade: Europe, USA	S235, A36	S355, Grade 50 and stronger steel
Tension, N_{rec} [kN/lb]	1.8 / 405	2.3 / 517
Shear, V_{rec} [kN/lb]	2.6 / 584	3.4 / 764
Moment, M_{rec} [Nm/lbft]	8.2 / 6	8.2 / 6
Torque, T_{rec} [Nm/lbft]	8 / 5.9	8 / 5.9

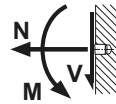

Example:

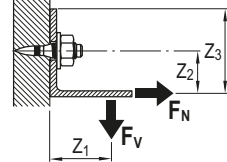

Recommended loads – cast iron*

Tension, N_{rec} [kN/lb]	0.5 / 115
Shear, V_{rec} [kN/lb]	0.75 / 170
Moment, M_{rec} [Nm/lbft]	8.2 / 6

Conditions for recommended loads

- Global factor of safety for static pull-out > 3 (based on 5% fractile value)
- Minimum edge distance = 6 mm [1/4"].
- Effect of base metal vibration and stress considered.
- Redundancy (multiple fastening) must be provided.
- The recommended loads in the table refer to the resistance of the individual fastening and may not be the same as the loads F_N and F_V acting on the fastened part.
Note: If relevant, prying forces need to be considered in design, see example.
Moment acting on fastener shank only in case of a gap between base and fastened material.

Design resistance – steel			
Steel grade:			
Europe		S235	S355
Tension	N_{Rd} [kN]	2.9	3.7
Shear	V_{Rd} [kN]	4.2	5.4
Moment	M_{Rd} [Nm]	18.4	18.4

Design resistance – cast iron*			
Tension	N_{Rd} [kN]	0.8	
Shear	V_{Rd} [kN]	1.2	
Moment	M_{Rd} [Nm]	13.1	

*Requirements of spheroidal graphite cast iron base material

Subject	Requirements
Cast iron	Spheroidal graphite cast iron according to EN 1563
Strength class	EN-GJS-400 to EN-GJS-600 according to EN 1563
Chemical analysis and amount of carbon	3.3–4.0 mass percentage
Microstructure	Form IV to VI (spherical) according to EN ISO 945-1:2010 Minimum size 7 according to Figure 4 of EN ISO 945-1:2010
Material thickness	$t_{II} \geq 20$ mm

Recommended interaction formula for combined loading - steel and cast iron base material

Combined loading situation	Interaction formula
V–N (shear and tension)	$\frac{V}{V_{rec}} + \frac{N}{N_{rec}} \leq 1.2$ with $\frac{V}{V_{rec}} \leq 1.0$ and $\frac{N}{N_{rec}} \leq 1.0$
V–M (shear and bending)	$\frac{V}{V_{rec}} + \frac{M}{M_{rec}} \leq 1.2$ with $\frac{V}{V_{rec}} \leq 1.0$ and $\frac{M}{M_{rec}} \leq 1.0$
N–M (tension and bending)	$\frac{N}{N_{rec}} + \frac{M}{M_{rec}} \leq 1.0$
V–N–M (shear, tension and bending)	$\frac{V}{V_{rec}} + \frac{N}{N_{rec}} + \frac{M}{M_{rec}} \leq 1.0$

Cyclic loading

- Anchorage of X-BT-MR-N threaded stud in steel base material is not affected by cyclic loading.
- Fatigue strength is governed by fracture of the shank. Inquire at Hilti for test data if high cycle loading has to be considered in the design.

Application recommendation

Thickness of base material

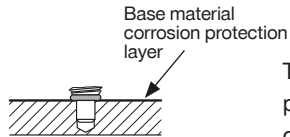
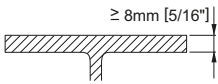

Thickness of base material corrosion protection layer $\leq 0.4\text{mm}$. For thicker coatings, please contact Hilti.

Thickness of fastened material

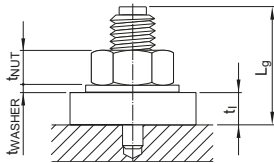

X-BT-MR-N M8/4 N 4: $t_1 \leq 4\text{ mm}$

X-BT-MR-N M8/14 N 4: $4\text{ mm} \leq t_1 \leq 14\text{ mm}$

For thickness less than 4 mm, reduction of shear loading is required, please contact Hilti.

Spacing and edge distances

Edge distance: $\geq 6\text{ mm}$

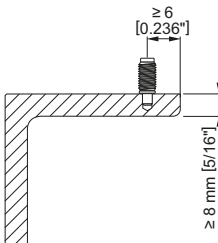

Spacing: $\geq 15\text{ mm}$

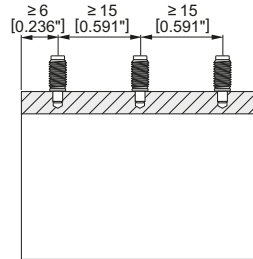

Application limit

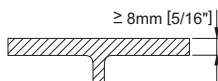

- $t_{II} \geq 8\text{ mm}$ [5/16"] \rightarrow No through penetration
- No limits with regards to steel strength

Corrosion information

The corrosion resistance of Hilti CR500 and S31803 stainless steel material is equivalent to AISI 316 (A4) steel grade.

Fastener program and system recommendation

Fastener program

Designation	Item no.	Tool Designation
X-BT-MR-N M8/14 N 4	2112004	DX 351 BT
X-BT-MR-N M8/4 N 4	2112003	DX 351 BTG

Cartridge selection and tool energy setting

6.8/11 M high precision brown cartridge

- Tool power level adjustment by setting tests on site.
- Start tool energy selection with lowest recommended tool power level.
- Correct according requirement from chapter quality assurance.

Quality assurance

Fastening inspection

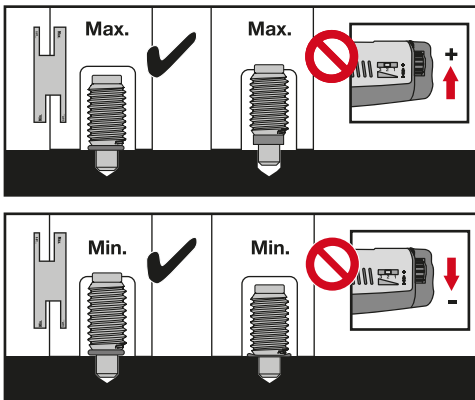

 X-BT-MR-N M8/4 N 4
 $h_{NVS} = 15.7-16.8 \text{ mm}$

 X-BT-MR-N M8/14 N 4
 $h_{NVS} = 25.7-26.8 \text{ mm}$

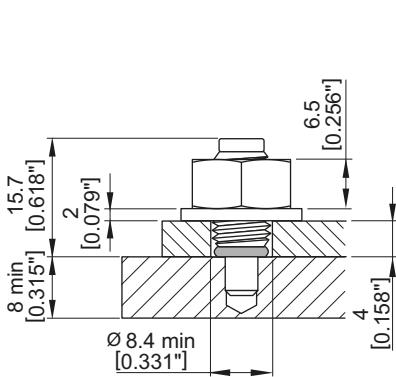
Installation recommendation

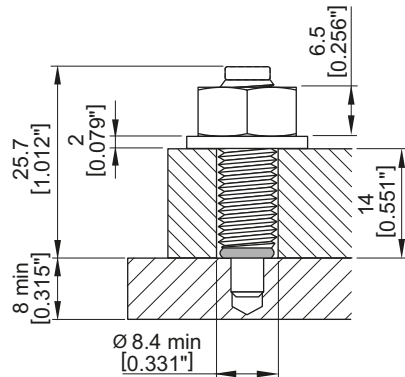

X-BT-MR-N M8/4 N4



X-BT-MR-N M8/14 N4

Pre-drill

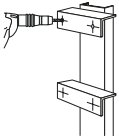

- Pre-drill with TX-BT 4/5.5 step shank drill bit.
- Pre-drill until the shoulder grinds a shiny ring (to ensure proper drilling depth).
- Before fastener installation: the drilled hole must be clear of liquids and debris.
The area around the drilled hole must be free from liquids and debris.

These are abbreviated instructions which may vary by application.

ALWAYS review/follow the instructions accompanying the product.

Tightening torque

	Fastener: X-BT-MR N
Element: nut	8 Nm

Tightening tool recommendation for tightening with cordless screwdriver

Cordless screwdriver	Clutch type (stop detection)	Gear	Clutch
SF 4-A22	TRC	1	8
SF 6-A22	ESC (HJ)	1	3
SF 6H-A22	ESC (HJ)	1	3
SFC 14-A	TRC	1	6
SFC 18-A	TRC	1	3
SFC 22-A	TRC	1	5
SBT 4-A22	TRC	1	7



• Tool power level adjustment:

Gear:



Clutch:



- The setting of the torque via the Hilti screwdriver with torque release coupling (TRC) can change as the clutch wears over time. The specified torque setting is only a rough guide value and applies to a new Hilti screwdriver. To ensure recommended torque is applied, Hilti recommends the use of a calibrated torque wrench or the Hilti torque tool.
- The specified torque setting for the Hilti screw drivers with electronic slip clutch (ESC) is only a rough guide value as the ESC has 2 stop detections; Soft Joint (SJ) detection and Hard Joint (HJ) detection. The hard joint detection is activated due to drop in speed (fast stop) and can lead to a torque spike. The installation torque may vary depending on the user and the application. To ensure recommended torque is applied, Hilti recommends the use of a calibrated torque wrench or the Hilti torque tool.

Tightening tool recommendation for tightening with Hilti torque tool

Hilti torque tool

Torque tool X-BT 1/4" – 8 Nm

S-BT Screw-in stainless steel and carbon steel threaded stud

Product data

Dimension

S-BT-MR M10/15 SN6 S-BT-MFM10/15 AN6
 S-BT-MR MT M10/15 SN6*) S-BT-MF MT M10/15 AN6*)
 S-BT-MR M10/15 SN6 AL**) S-BT-MF W10/15 AN6
 S-BT-MR W10/15 SN6
 S-BT-MR W10/15 SN6 AL**)

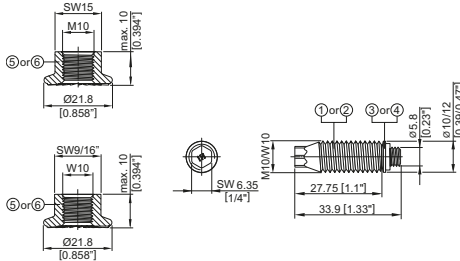

S-BT-MRM8/7 SN6 S-BT-MFM8/7 AN6
 S-BT-MR MT M8/7 SN6*) S-BT-MF MT M8/7 AN6*)
 S-BT-MRM8/7 SN6 AL**) S-BT-GFM8/7 AN6*)
 S-BT-GRM8/7 SN6*) S-BT-GFNGM8/7 SN6*)
 S-BT-GRNGM8/7 SN6*)
 S-BT-GRM8/7 SN6 AL**) **)

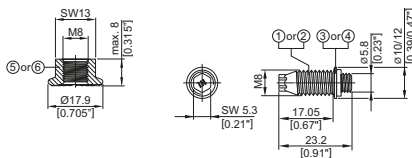

S-BT-MRM8/15 SN6
 S-BT-MRM8/15 SN6 AL**)

S-BT-MFM8/15 AN6

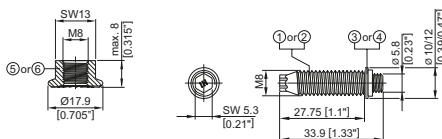

Material specification

- ① Threaded shank: Stainless steel (S-BT-_R) "S 31803 (1.4462)" zinc-coated
- ② Threaded shank: Carbon steel (S-BT-_F) "1038/duplex-coated"
- ③ SN 12-R washers: Ø 12 mm [0.47"]
Stainless steel (S-BT-_R) "S 31635 (1.4404)"
- ④ AN10-F washers: Ø 10 mm [0.39"]
Aluminum (S-BT-_F)
- ⑤ Serrated flange nut*): Stainless steel (S-BT-MR) grade A4 – 70/80
- ⑥ Serrated flange nut*): Carbon steel (S-BT-MF) HDG, grade 8

Sealing ring of sealing washers: Chloroprene rubber CR 3.1107, black resistant to UV, salt water, water, ozone, oils, etc.

Assessments, Reports and Type Approvals

ETA-20/0530
 ICC-ES ESR-4185
 ABS: 16-HS1550085-PDA
 DNV-GL: TAS0000N6
 LR: 16/00063
 BV: 45116/A BV
 Russian Maritime Register of Shipping: 18.40040.250
 RINA: FPE278318CS
 China Classification Society CCS: NJ17P2016



*) package does not include serrated flange nuts
 **) for use in aluminum base material

Applications

Examples

Multipurpose Fastening	Grating with X-FCM X-FCM NG and X-FCS-R *)
S-BT-MR _____ S-BT-MF _____	S-BT-GR _____ S-BT-GF _____

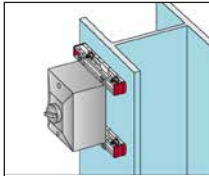

Junction box, etc.

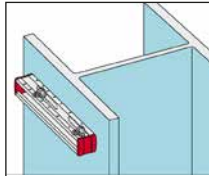

Channel installation

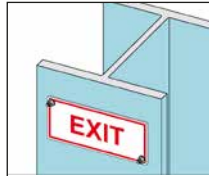

Signage

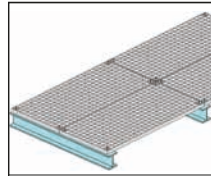

Grating fastening

*) Load data, application requirements, corrosion information, fastener selection, system recommendation, material specification and coating refer to section X-FCM Grating Fastening System, X-FCM NG Grating Fastening System or X-FCS-R Grating Fastening System in the Hilti Direct Fastening Technology Manual.

Load data

Recommended loads

Base material thickness ¹⁾	S-BT-MR and S-BT-GR made of stainless steel					
	$t_{II} \geq 5 \text{ mm [0.20"]}$			$3 \text{ mm [0.12"]} \leq t_{II} < 5 \text{ mm [0.20"]}$		
Base material type	Steel S235 A36	Steel S355, S420 Grade 50	Aluminum $f_u \geq 270 \text{ MPa}$	Steel S235 A36	Steel S355, S420 Grade 50	
Tension, N_{rec} [kN/lb]	1.9/425	2.3/515	1.9/425	1.8/405	2.1/470	
Shear, V_{rec} [kN/lb] For edge distance $6 \text{ mm [0.24"]} \leq c < 15 \text{ mm [0.59"]}$	2.5/560	2.8/625	2.9/650	2.4/540	2.5/560	
Shear, V_{rec} [kN/lb] For edge distance $c \geq 15 \text{ mm [0.59"]}$	4.0/895	4.0/895	3.5/785	3.8/850	3.8/850	
Moment, M_{rec} [Nm/lbft]	11.1/8.0					
Base material thickness ¹⁾	S-BT-MF and S-BT-GF made of duplex coated carbon steel					
	$t_{II} \geq 5 \text{ mm [0.20"]}$			$3 \text{ mm [0.12"]} \leq t_{II} < 5 \text{ mm [0.20"]}$		
Base material type	Steel S235 A36	Steel S355, S420 Grade 50	Aluminum $f_u \geq 270 \text{ MPa}$	Steel S235 A36	Steel S355, S420 Grade 50	
Tension, N_{rec} [kN/lb]	2.0/450	2.4/540	n.a.	1.9/425	2.3/515	
Shear, V_{rec} [kN/lb] For edge distance $6 \text{ mm [0.24"]} \leq c < 15 \text{ mm [0.59"]}$	2.5/560	2.8/625	n.a.	2.4/540	2.5/560	
Shear, V_{rec} [kN/lb] For edge distance $c \geq 15 \text{ mm [0.59"]}$	2.7/605	2.9/650	n.a.	2.7/605	2.9/650	
Moment, M_{rec} [Nm/lbft]	6.7/5.0			6.7/5.0		

¹⁾ For base material thickness $3 \text{ mm [0.12"]} \leq t_{II} < 6 \text{ mm [0.24"]}$ rework of the coating on the back side of the plate/profile may be needed.

Design loads

	S-BT-MR and S-BT-GR made of stainless steel				
Base material thickness ¹⁾	$t_{II} \geq 5 \text{ mm [0.20"]}$			3 mm [0.12"] $\leq t_{II} < 5 \text{ mm [0.20"]}$	
Base material type	Steel S235 A36	Steel S355, S420 Grade 50	Aluminum $f_u \geq 270 \text{ MPa}$	Steel S235 A36	Steel S355, S420 Grade 50
Tension, N_{Rd} [kN/lb]	2.7/605	3.2/715	2.7/605	2.5/560	3.0/670
Shear, V_{Rd} [kN/lb] For edge distance $6 \text{ mm [0.24"]} \leq c < 15 \text{ mm [0.59"]}$	3.5/785	3.9/875	4.0/895	3.4/760	3.5/785
Shear, V_{Rd} [kN/lb] For edge distance $c \geq 15 \text{ mm [0.59"]}$	5.6/1255	5.6/1255	5.0/1120	5.3/1190	5.3/1190
Moment, M_{Rd} [Nm/lbft]	15.6/12.0				
	S-BT-MF and S-BT-GF made of duplex coated carbon steel				
Base material thickness ¹⁾	$t_{II} \geq 5 \text{ mm [0.20"]}$			3 mm [0.12"] $\leq t_{II} < 5 \text{ mm [0.20"]}$	
Base material type	Steel S235 A36	Steel S355, S420 Grade 50	Aluminum $f_u \geq 270 \text{ MPa}$	Steel S235 A36	Steel S355, S420 Grade 50
Tension, N_{Rd} [kN/lb]	2.8/625	3.3/740	n.a.	2.7/605	3.2/715
Shear, V_{Rd} [kN/lb] For edge distance $6 \text{ mm [0.24"]} \leq c < 15 \text{ mm [0.59"]}$	3.5/785	3.9/875	n.a.	3.4/760	3.5/785
Shear, V_{Rd} [kN/lb] For edge distance $c \geq 15 \text{ mm [0.59"]}$	3.8/850	4.0/895	n.a.	3.8/850	4.0/895
Moment, M_{Rd} [Nm/lbft]	9.4/7.0		n.a.	9.4/7.0	

¹⁾ For base material thickness $3 \text{ mm [0.12"]} \leq t_{II} < 6 \text{ mm [0.24"]}$ rework of the coating on the back side of the plate/profile may be needed.

Conditions for recommended loads and design loads:

- Use S-BT-MR and S-BT-MF (multipurpose fastening) only with the supplied Hilti serrated flange nuts M8, M10, W10 (⑤) or (⑥) as per according to General Information – Material specifications)
- Global factor of safety Ω resp. partial factor of safety γ_m (based on 5 % fractile ultimate test value)

	Recommended loads	Design loads
static pull-out	2.80	2.00
static shear	2.80	2.00
Bending	1.75	1.25
- Minimum edge distance = 6 mm [0.24"] , minimum spacing $\geq 18 \text{ mm [0.709"]}$
- Effect of base metal vibration and stress (e.g. areas with tensile stress) considered.
- Redundancy (multiple fastening) must be provided.
- If eccentric loading exists (e.g. use of an angle clip), moments caused by off-center loading must be considered.

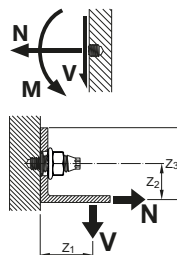

Cyclic loading

S-BT threaded studs are only to be used for fastenings subject to static or quasi-static loading. Inquire at Hilti for test data if cyclic loading has to be considered in the design.

Recommended interaction formula for combined loading

$$V-N \text{ (shear and tension)} \quad \frac{V}{V_{rec}} + \frac{N}{N_{rec}} \leq 1.0 \text{ with } \frac{V}{V_{rec}} \leq 1.0 \text{ and } \frac{N}{N_{rec}} \leq 1.0$$

$$V-M \text{ (shear and bending)} \quad \frac{V}{V_{rec}} + \frac{M}{M_{rec}} \leq 1.0 \text{ with } \frac{V}{V_{rec}} \leq 1.0 \text{ and } \frac{M}{M_{rec}} \leq 1.0$$

$$N-M \text{ (tension and bending)} \quad \frac{N}{N_{rec}} + \frac{M}{M_{rec}} \leq 1.0$$

$$V-N-M \text{ (shear, tension and bending)} \quad \frac{V}{V_{rec}} + \frac{N}{N_{rec}} + \frac{M}{M_{rec}} \leq 1.0$$

Application Requirements

Base material thickness t_{II} and type of bore hole

S-BT-MR M8/7 SN 6
 S-BT-MR MT M8/7 SN 6
 S-BT-MR M8/7 SN 6 AL*)
 S-BT-MF M8/7 AN 6
 S-BT-MF MT M8/7 AN 6
 S-BT-GR M8/7 SN 6
 S-BT-GR NG M8/7 SN 6*)
 S-BT-GR M8/7 SN 6 AL*)
 S-BT-GF M8/7 AN 6
 S-BT-GF NG M8/7 AN 6*)

S-BT-MR M8/15 SN 6
 S-BT-MR M8/15 SN 6 AL*)
 S-BT-MF M8/15 AN 6

S-BT-MR M10/15 SN 6
 S-BT-MR M10/15 SN 6 AL*)
 S-BT-MF M10/15 AN 6
 S-BT-MR W10/15 SN 6
 S-BT-MR W10/15 SN 6 AL*)
 S-BT-MF W10/15 AN 6

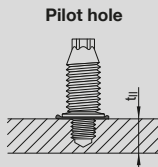

Base material thickness
 steel and aluminum: $t_{II} \geq 6 \text{ mm}$ [0.24"]

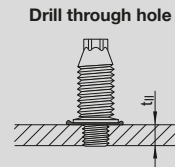

Base material thickness
 steel: 3 mm [0.12"] $\leq t_{II} < 6 \text{ mm}$ [0.24"]
 aluminum: 5 mm [0.20"] $\leq t_{II} < 6 \text{ mm}$ [0.24"]

*) for use in aluminum base material

Thickness of base material corrosion protection layer $\leq 0.8 \text{ mm}$ [0.0315"].
 For thicker coatings, please contact Hilti.

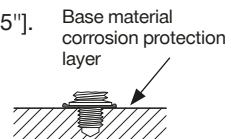

Thickness of fastened material t_l

 S-BT-____/7____ $1.6 \text{ mm } [0.063"] \leq t_l \leq 7.0 \text{ mm } [0.28"]$

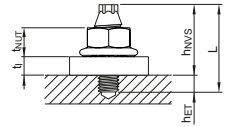
 S-BT-____/15____ $1.6 \text{ mm } [0.063"] \leq t_l \leq 15.0 \text{ mm } [0.59"]$

Spacing & edge distances

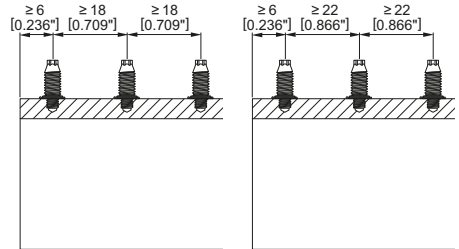
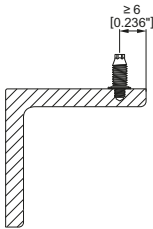
 Edge distance: $\geq 6 \text{ mm } [0.24"]$

 Spacing: $\geq 18 \text{ mm } [0.709"]$ for all S-BT M8
 $\geq 22 \text{ mm } [0.866"]$ for all S-BT M10
 and S-BT W10

Corrosion information

The S-BT stainless steel fasteners are made from the duplex stainless steel type 1.4462, which is equivalent to AISI 316 (A4) steel grade. This grade of stainless steel is classified in the corrosion resistance class IV according to DIN EN 1993-1-4:2015, which makes the material suitable for aggressive environments like in coastal and offshore applications.

The microstructures of duplex stainless steels consist of a mixture of austenite and ferrite phases. Compared to the austenitic stainless steel grades, duplex stainless steels are magnetic. The surface of the S-BT stainless steel fasteners is zinc-coated (anti-friction coating) in order to reduce the thread forming torque when the stud is screwed in into the base material.

The coating of the carbon steel S-BT fasteners consists of an electroplated Zn-alloy for cathodic protection and a top coat for chemical resistance (Duplex-coating). The thickness of the coating is 35 μm . The use of this coating is limited to the corrosion category C1, C2 and C3 according the standard EN ISO 9223. For higher corrosion categories stainless steel fasteners should be used.

In case of a drill through hole or a pilot hole in thin base material, rework of the coating on the back side of the plate/profile may be needed.

Note: ETA-20/0530 allows the use of carbon steel threaded studs with duplex coating only in dry indoor environment (C1 acc. to EN ISO 9223).

	S-BT-MF, S-BT-GF		S-BT-MR, S-BT-GR	
Corrosivity category C	C3 medium corrosive		C5 very high corrosive	
Drill hole type and base material thickness $t_{II}^{1)}$	Topside protection	Backside protection	Topside protection	Backside protection
Drill through hole $3 \text{ mm } [0.12"] \leq t_{II} < 6 \text{ mm } [0.24"]$	✓	x ²⁾	✓	x ²⁾
Pilot hole $6 \text{ mm } [0.24"] \leq t_{II} < 7 \text{ mm } [0.28"]$	✓	✓	✓	✓ ³⁾
Pilot hole $t_{II} \geq 7 \text{ mm } [0.28"]$	✓	✓	✓	✓

¹⁾ Real base material thickness, not nominal material thickness or material thickness with coating.

²⁾ Damage of the coating on the back side of the plate/profile require a rework of the coating.

³⁾ Damage of the coating on the back side of the plate/profile require a rework of the coating, if the drilling tools SF BT22-A or SF BT18-A were used for drilling the bore hole. If the drilling tool SBT 4-A22 was used for drilling the bore hole, no damage of the coating on the back side of the plate/profile will occur.

Application limit

The base material is limited to steel grade with a maximum tensile strength $f_u = 630 \text{ MPa } [91 \text{ ksi}]$.

The minimum tensile strength of steel is $f_u \geq 340 \text{ MPa } [49 \text{ ksi}]$.

The minimum tensile strength of aluminum is $f_u \geq 270 \text{ MPa } [39 \text{ ksi}]$.

Minimum thickness of base material t_{II} : refer to section “Application Requirements”

Maximum thickness of base material t_{II} : no limits

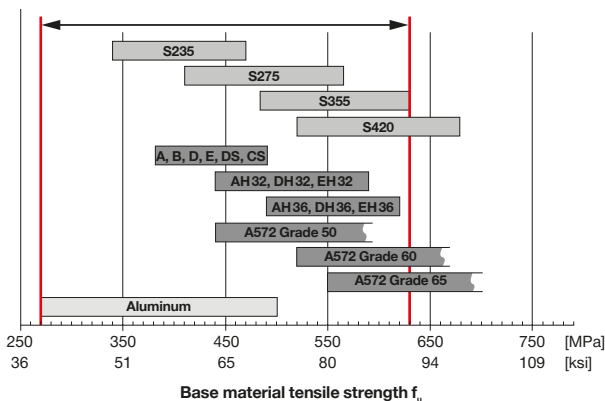

Fastener selection and system recommendation

	Fastener	Drilling tool	Drill bit	Setting tool	Depth gauge
Stainless steel	S-BT-MR M8/7 SN6	SBT 4-A22 or SF BT 18-A or SF BT 22-A	TS-BT 5.5-74 S	SBT 4-A22 or SF 4-A22 or SFC 18-A or SFC 22-A	S-DG BT M8/7 Short 6
	S-BT-MR MT8/7 SN6		TS-BT 5.5-74 AL		
	S-BT-MR M8/7 SN6AL		TS-BT 5.5-74 S		
	S-BT-MR M8/15 SN6		TS-BT 5.5-74 AL		S-DG BT M8/15 Long 6
	S-BT-MR M8/15 SN6AL		TS-BT 5.5-74 S		
	S-BT-MR M8/15 SN6AL		TS-BT 5.5-74 S		
	S-BT-MR M8/7 SN6		TS-BT 5.5-74 S		S-DG BT M8/7 Short 6
	S-BT-MR M8/7 SN6AL		TS-BT 5.5-74 S		
	S-BT-MR M8/7 SN6		TS-BT 5.5-110 S		
	S-BT-MR M10/15 SN6		TS-BT 5.5-74 S		S-DG BT M10-W10/15 Long 6
	S-BT-MR MT M10/15 SN6		TS-BT 5.5-74 AL		
	S-BT-MR M10/15 SN6AL		TS-BT 5.5-74 S		
	S-BT-MR W10/15 SN6		TS-BT 5.5-74 AL		
S-BT-MR W10/15 SN6AL	TS-BT 5.5-110 S	S-DG BT M8/7 Short 6			
S-BT-GF NG M8/7 AN6	TS-BT 5.5-74 S				
S-BT-GF M8/7 AN6					
S-BT-MF MT M8/7 AN6					
S-BT-MF M8/15 AN6					
S-BT-MF M10/15 AN6					
S-BT-MF MT M10/15 AN6					
S-BT-MF W10/15 AN6		S-DG BT M10-W10/15 Long 6			

Fastener quality assurance

In order to ensure the exact screw-in depth and a proper compressed sealing washer, the S-BT studs have to be installed with the appropriate depth gauge. With this tool the screw-in depth can be adjusted in a range of 0–1.5 mm (3 steps, 0.5mm per step).

The S-CC BT calibration card is needed to check the initial stand-off of the S-BT stud and to adjust/calibrate the S-DG BT depth gauge. After finding the right adjustment level for the S-DG BT depth gauge, the gauge can be adjusted and the studs can be installed without additional check of the S-DG BT depth gauge.

The depth gauge has to be re-adjusted (calibrated) at following times:

- Start of the installation process
- Change of the working position (upwards, downwards, horizontal) and base material (thickness, strength, type)
- Installer change
- After each packaging respectively after the installation of 100 S-BT studs

The lifetime of the S-DG BT depth gauge is ≥ 1000 settings.

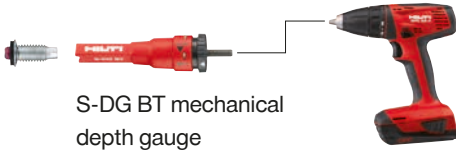

S-DG BT mechanical depth gauge

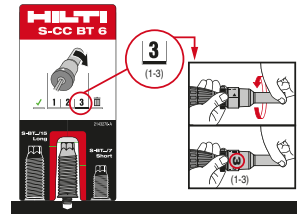

Design and functionality of the mechanical calibration card S-CC BT

Fastening inspection

The installer is responsible for the correct setting of the S-BT studs. For the periodical verification of the correct stud stand-off the S-CG BT check gauge can be used.



Design and functionality of the check gauge S-CG BT

Verify stud stand-off h_{NVS} with check gauge S-CG BT

S-BT-___/7___6 $h_{NVS} = 18.6 \text{ mm to } 19.1 \text{ mm}$
[0.732" to 0.752"]

S-BT-___/15___6 $h_{NVS} = 29.3 \text{ mm to } 29.8 \text{ mm}$
[1.153" to 1.173"]

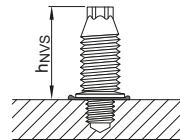

Designation	Product name	Comment
S-DG BT M8/7 Short 6	Depth gauge	for exact setting of S-BT M8/7
S-DG BT M8/15 Long 6	Depth gauge	for exact setting of S-BT M8/15
S-DG BT M 10-W 10/15 Long 6	Depth gauge	for exact setting of S-BT M 10/W 10
S-CC BT 6	Calibration card	for calibration of the depth gauge (short/long studs)
S-CG BT/7 Short 6	Check gauge	for verification of the stand-off for short studs (7 mm)
S-CG BT/15 Long 6	Check gauge	for verification of the stand-off for long studs (15 mm)

Installation recommendation

S-BT fasteners made of stainless steel with washer-Ø 12 mm (S-BT-_R)

Fastened material hole $\varnothing \geq 13$ mm [0.51"]

S-BT fasteners made of carbon steel with washer-Ø 10 mm (S-BT-_F)

Fastened material hole $\varnothing \geq 11$ mm [0.43"]

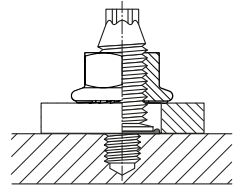

Important:

For group fastenings subjected to shear loading the fastened material hole diameter should not exceed 14 mm [0.55"] (S-BT-_R) and 12 mm [0.47"] (S-BT-_F) respectively.

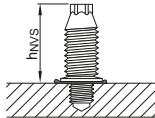
1 Mark location for each fastening	2 Pre-drill with TS-BT stepped drill bit	3 Screw-in S-BT studs into drilled hole	4 Fasten channel on base material	5 Fasten accessory on channel
<p>Usage of SBT 4-A22, SF BT 18-A or SF BT 22-A. Pre-drill until the shoulder grinds a shiny ring to assure proper drilling depth.</p>  <p>Before fastener installation: The drilled hole and the area around the drilled hole must be clear of liquids and debris.</p>		<p>Usage of SBT 4-A22, SFC 18-A or SFC 22-A in combination with the calibrated depth gauge S-DG BT.</p> <p>Verify stud stand-off h_{res} with check gauge S-CG BT</p>  <p>Sealing washer must be properly compressed!</p>	<p>Position channel on S-BT studs and hold in place. Tighten the nuts with the suited tightening torque T_{rec}.</p>	<p>Tighten the bolts with the suited tightening torque T_{rec} (see IFU of the Hilti wing nuts).</p>
<p>Important: These are abbreviated instructions which may vary by application. ALWAYS review/follow the instructions for use (IFU) accompanying the product. In case of a drill through hole, rework of the coating on the back side of the plate/profile may be needed.</p>				

Tightening torque for fastening to steel base material $t_{II} \geq 6 \text{ mm}$

	Fastener: S-BT-MF, S-BT-MR
Element: nut	8 Nm

Tightening tool recommendation for tightening with cordless screwdriver

Cordless screwdriver	Clutch type (stop detection)	Gear	Clutch
SF 4-A22	TRC	1	8
SF 6-A22	ESC (HJ)	1	3
SF 6H-A22	ESC (HJ)	1	3
SBT 4-A22	TRC	1	7
SFC 18-A	TRC	1	5
SFC 22-A	TRC	1	5



• Tool power level adjustment:

Gear:



Clutch:



- The setting of the torque via the Hilti screwdriver with torque release coupling (TRC) can change as the clutch wears over time. The specified torque setting is only a rough guide value and applies to a new Hilti screwdriver. To ensure recommended torque is applied, Hilti recommends the use of a calibrated torque wrench or the Hilti torque tool.
- The specified torque setting for the Hilti screw drivers with electronic slip clutch (ESC) is only a rough guide value as the ESC has 2 stop detections; Soft Joint (SJ) detection and Hard Joint (HJ) detection. The hard joint detection is activated due to drop in speed (fast stop) and can lead to a torque spike. The installation torque may vary depending on the user and the application. To ensure recommended torque is applied, Hilti recommends the use of a calibrated torque wrench or the Hilti torque tool.

Tightening tool recommendation for tightening with Hilti torque tool

Hilti torque tool
Torque tool X-BT 1/4" – 8 Nm

Tightening torque for fastening to aluminum base material and in steel base material
 $3 \text{ mm} \leq t_{II} < 5 \text{ mm}$ (drill through hole)

	Fastener: S-BT-MF, S-BT-MR, S-BT-MR AL
Element: nut	5 Nm

Tightening tool recommendation for tightening with cordless screwdriver

Cordless screwdriver	Clutch type (stop detection)	Gear	Clutch
SF 2-A12	TRC	1	15
SF 2H-A12	TRC	1	15
SF 4-A22	TRC	1	4
SF 6-A22	ESC (HJ)	1	2
SF 6H-A22	ESC (HJ)	1	2
SBT 4-A22	TRC	1	5
SFC 18-A	TRC	1	4
SFC 22-A	TRC	1	4



• Tool power level adjustment:



Clutch:



- The setting of the torque via the Hilti screwdriver with torque release coupling (TRC) can change as the clutch wears over time. The specified torque setting is only a rough guide value and applies to a new Hilti screwdriver. To ensure recommended torque is applied, Hilti recommends the use of a calibrated torque wrench or the Hilti torque tool.
- The specified torque setting for the Hilti screw drivers with electronic slip clutch (ESC) is only a rough guide value as the ESC has 2 stop detections; Soft Joint (SJ) detection and Hard Joint (HJ) detection. The hard joint detection is activated due to drop in speed (fast stop) and can lead to a torque spike. The installation torque may vary depending on the user and the application. To ensure recommended torque is applied, Hilti recommends the use of a calibrated torque wrench or the Hilti torque tool.

Tightening tool recommendation for tightening with Hilti torque tool

Hilti torque tool

Torque tool S-BT 1/4" – 5 Nm

	S-BT-MR, S-BT-MF, S-BT-GR, S-BT-GF				
Base material thickness	$t_{II} \geq 5 \text{ mm [0.20"]}$			3 mm [0.12"] $\leq t_{II} < 5 \text{ mm [0.20"]}$	
Base material type	Steel S235 A36	Steel S355 Grade 50	Aluminum $f_u \geq 270 \text{ MPa}$	Steel S235 A36	Steel S355 Grade 50
Tightening torque serrated flange nut T_{rec} [Nm/lbft]	8/5.9	8/5.9	5/3.6	5/3.6	5/3.6

Important: The tightening torque (T_{rec}) for the serrated flange nut is dependent on the stud type, the base material type and thickness, and the drill hole type. Exceeding the tightening torque (T_{rec}) leads to damage of the S-BT stud's anchorage with negative impact on the load values and the sealing function.

System program

Designation	Item no.	Product name	Comment	Application
S-BT-GF M8/7 AN6	2140527	Threaded stud	use with X-FCM grating disc	Grating
S-BT-GF NG M8/7 AN6	2302143	Threaded stud	use with X-FCM-M NG grating disc	Grating
S-BT-MF M8/7 AN6	2139174	Threaded stud	package includes serrated flange nut	Multipurpose
S-BT-MF MT M8/7 AN6	2298450	Threaded stud	package does not include serrated flange nut	Multipurpose
S-BT-MF M8/15 AN6	2148618	Threaded stud	package includes serrated flange nut	Multipurpose
S-BT-MF M10/15 AN6	2140528	Threaded stud	package includes serrated flange nut	Multipurpose
S-BT-MF MT M10/15 AN6	2309240	Threaded stud	package does not include serrated flange nut	Multipurpose
S-BT-MF W10/15 AN6	2139173	Threaded stud	package includes serrated flange nut	Multipurpose
S-BT-GR M8/7 SN6	2140529	Threaded stud	use with X-FCM grating disc	Grating
S-BT-GR M8/7 SN6AL	2140742	Threaded stud	use with X-FCM grating disc	Grating
S-BT-GR NG M8/7 SN6	2302142	Threaded stud	use with X-FCM-R NG grating disc	Grating
S-BT-MR M8/7 SN6	2139172	Threaded stud	package includes serrated flange nut	Multipurpose
S-BT-MR MT M8/7 SN6	2298451	Threaded stud	package does not include serrated flange nut	Multipurpose
S-BT-MR M8/7 SN6AL	2140743	Threaded stud	package includes serrated flange nut	Multipurpose
S-BT-MR M8/15 SN6	2148612	Threaded stud	package includes serrated flange nut	Multipurpose
S-BT-MR M8/15 SN6AL	2148614	Threaded stud	package includes serrated flange nut	Multipurpose
S-BT-MR M10/15 SN6	2140740	Threaded stud	package includes serrated flange nut	Multipurpose
S-BT-MR MT M10/15 SN6	2205156	Threaded stud	package does not include serrated flange nut	Multipurpose
S-BT-MR M10/15 SN6AL	2140744	Threaded stud	package includes serrated flange nut	Multipurpose
S-BT-MR W10/15 SN6	2140741	Threaded stud	package includes serrated flange nut	Multipurpose
S-BT-MR W10/15 SN6AL	2140745	Threaded stud	package includes serrated flange nut	Multipurpose

Designation	Item no.	Product name	Comment	Application
TS-BT 5.5-74 S	2143137	Stepped drill bit	for base material steel	Grating
TS-BT 5.5-110 S	2201685	Stepped drill bit	For use in combination with the S-CS NG centering Spacer	
TS-BT 5.5-74 AL	2143138	Stepped drill bit	for base material aluminum	
S-CS NG	2310191	Centering Spacer	For perpendicular pilot hole drilling and precise location of studs	Grating
S-DG BT M8/7 Short 6	2279735	Depth gauge	for exact setting of the S-BT	
S-DG BT M10-W10/15 Long 6	2143261	Depth gauge	for exact setting of the S-BT	
S-DG BT M8/15 Long 6	2148575	Depth gauge	for exact setting of the S-BT	
S-CG BT/7 Short 6	2143262	Check gauge	for verification of the stud stand-off	
S-CG BT/15 long 6	2143263	Check gauge	for verification of the stud stand-off	
S-CC BT 6	2143270	Calibration card	for calibration of the depth gauge	
S-BT 1/4" - 5 Nm	2143271	Torque tool	manual torque tool (5 Nm)	
X-BT 1/4" - 8 Nm	2119272	Torque tool	manual torque tool (8 Nm)	
S-NS 13 C 95/3 3/4"	2149244	Nut setter	for serrated flange nut M8	
S-NS 15 C 95/3 3/4"	2149245	Nut setter	for serrated flange nut M10	
S-NS 9/16" C 95/3 3/4"	2149246	Nut setter	for serrated flange nut W10	

X-ST-GR Stainless steel threaded stud for fastening to steel

Product data

Dimensions

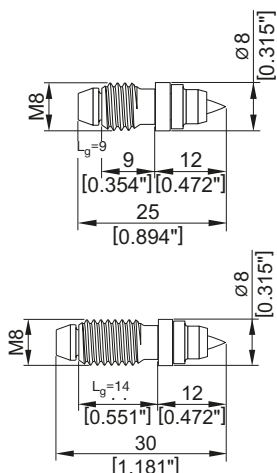

Material specifications

Shank: P558 (CrMnMo alloy)
 $f_u \geq 2000 \text{ N/mm}^2$

Threaded sleeve: A4 (AISI 316)

Washers: polyethylene

Recommended fastening tools

DX 6 F8, DX 5 F8, DX 460 F8, DX 76 PTR

• See fastener program in the next pages.

Approvals

ICC ESR-2347

ABS

• Not all information presented in this product data sheet might be subject to approval/certificate content. Please refer to approval/certificate for further information.

Applications

Examples

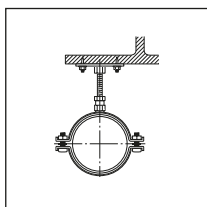

Base plates for pipe rings

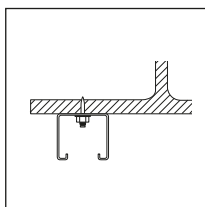

Installation rails

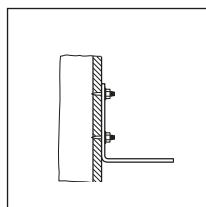

Facade brackets

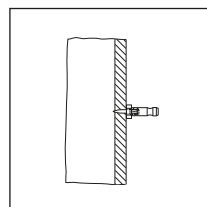

Special purpose connections

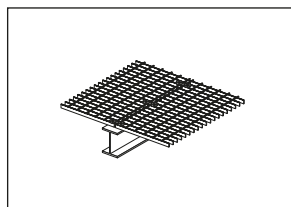

Grating

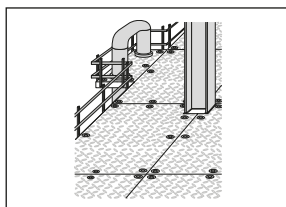

Checker plate

Performance data

Recommended resistance under tension load, shear load and bending moment

N_{rec}	V_{rec}	M_{rec}
1.8 kN	1.8 kN	5.5 Nm

Condition:

- For safety-relevant fastenings sufficient redundancy of the entire system is required.

Arrangements to reduce or prevent moment on shank

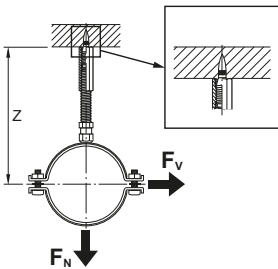

Application recommendation

Base material thickness

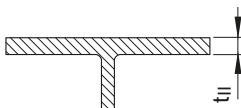

$$t_{II} \geq 6 \text{ mm}$$

Fastened material thickness

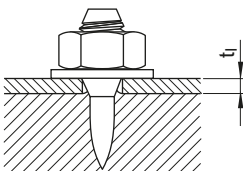

$$t_I \leq L_g - t_{\text{washer}} - t_{\text{nut}}$$

$$t_I \leq 10 \text{ mm for X-ST-GR M8/10 P8}$$

$$t_I \leq 5 \text{ mm for X-ST-GR M8/5 P8}$$

Fastener positioning in base material

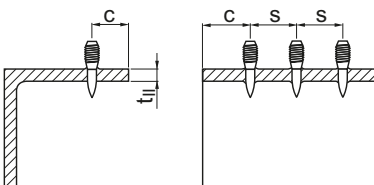

Edge distance: $c \geq 15 \text{ mm}$
 Spacing: $s \geq 15 \text{ mm}$

Application limit

Tool type: DX 6 F8, DX 5 F8, DX 460 F8

Tool type: DX 76 PTR

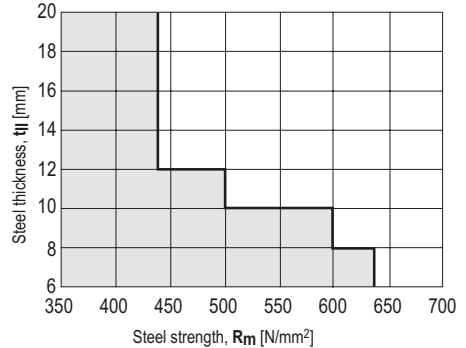
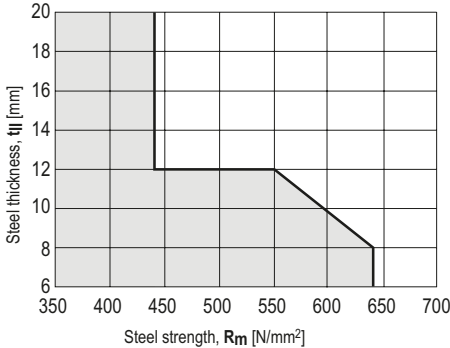

Corrosion information

- For fastenings exposed to outdoor environments in mildly corrosive conditions where HDG coated parts are commonly specified or used.
- Not for use in atmospheres with chlorides (marine atmospheres) or in heavily polluted environments (e.g. sulphur dioxide).
- For more details, please refer to following technical document: Hilti Corrosion Handbook.

System recommendation

- For more details, please refer to the chapter **Accessories and consumables compatibility** in the Direct Fastening Technology Manual (DFTM).

Cartridge recommendation

Base material		Cartridge color (tool power level)	
		Tool type: DX 6 F8	Tool type: DX 5 F8, DX 460 F8
		Cartridge type: 6.8/11 M	Cartridge type: 6.8/11 M
S235	$6 \leq t_{II} \leq 8$ mm	titanium ■ (4-6)	red ■ (1-3)
	$8 < t_{II} \leq 20$ mm	titanium ■ (5-8), black ■ (6-7)	black ■ (1-3)
S275	$6 \leq t_{II} \leq 12$ mm	titanium ■ (5-8), black ■ (6-7)	black ■ (1-3)
S355	$6 \leq t_{II} \leq 8$ mm	titanium ■ (5-8), black ■ (6-7)	black ■ (1-3)

Cartridge recommendation

Base material		Cartridge color (tool power level)	
		Tool type: DX 76 PTR	
		Cartridge type: 6.8/18 M	
S235	$6 \leq t_{ } \leq 8 \text{ mm}$	yellow ■ (1-4)	
	$8 < t_{ } \leq 20 \text{ mm}$	yellow ■ (1-4)	
S275	$6 \leq t_{ } \leq 12 \text{ mm}$	yellow ■ (1-4), red ■ (1-2)	
S355	$6 \leq t_{ } \leq 8 \text{ mm}$	red ■ (1)	
	$8 < t_{ } \leq 10 \text{ mm}$	red ■ (1-2)	



- Tool power level adjustment by setting tests on site.
- Start tool energy selection with lowest recommended tool power level.
- Correct according requirement from chapter quality assurance.

Quality assurance

Setting depth control

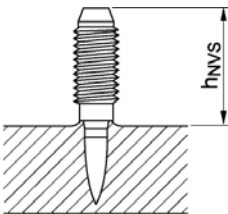

Designation	h_{NVS}
X-ST-GR M8/5 P8	12.0–15.0 mm
X-ST-GR M8/10 P8	17.0–20.0 mm

Installation information

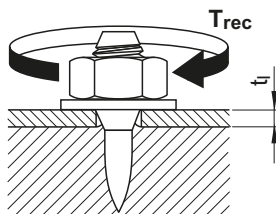

Tightening torque:

$T_{rec} = 8.5 \text{ Nm}$

Fastener program

Item no. and description

Designation	Item no.	L_g
X-ST-GR M8/5 P8	2122209	9 mm
X-ST-GR M8/10 P8	2122460	14 mm

X-CR M Stainless steel threaded stud for fastening to concrete and steel

Product data

Dimensions

X-CR M8-__-42 P8 (DX-Kwik)

Threaded sleeve: A4 (AISI 316)

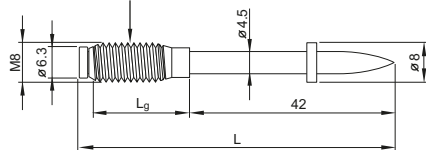

X-CR M8-15-12 FP10

Threaded sleeve: A4 (AISI 316)

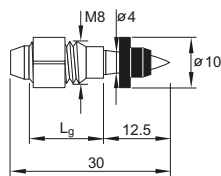

X-CRM8-9-12 P8

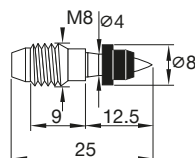

Material specifications

Shank: CrNiMo alloy
 $f_u \geq 1800 \text{ N/mm}^2$
 (49 HRC)

Threaded sleeve: A4 (AISI 316)

Zinc coating to improve anchoring in concrete

(X-CR M8-__-42): 5–13 μm

Washers/
 guidance sleeve: polyethylene

Recommended fastening tools

DX 6, DX 5, DX 460, DX 36, DX 2, DX 76,
 DX 76 PTR

- See fastener program in the next pages.

Approvals

DIBt (Germany): X-CR M8-__-42 P8
 (DX-Kwik)
 ICC ESR-2347: X-CR M8-9-12,
 ABS, LR: X-CR M8-15-12

- Not all information presented in this product data sheet might be subject to approval/certificate content. Please refer to approval/certificate for further information.

Applications

Examples

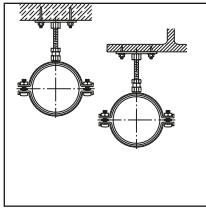

Base plates for pipe rings

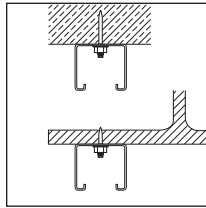

Installation rails

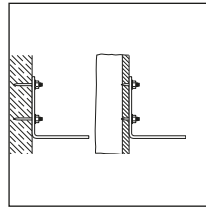

Facade brackets

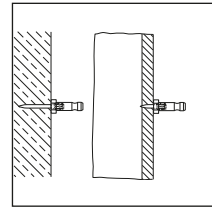

Special purpose connections

Performance data

Recommended resistance under tension load, shear load and bending moment

Fastening to steel

	N_{rec}	V_{rec}	M_{rec}
X-CR M8	1.8 kN	1.8 kN	5.5 Nm

Conditions

- For safety-relevant fastenings sufficient redundancy of the entire system is required.

Fastening to concrete – DX-Kwik method (pre-drilling)

	$N_{rec,1}$	$N_{rec,2}$	V_{rec}	M_{rec}
X-CR M8-__-42 P8	3.0 kN	0.9 kN	3.0 kN	5.5 Nm

Conditions

- $N_{rec,1}$: concrete in compressive zone
- $N_{rec,2}$: concrete in tension zone
- $f_{cc} \geq 20 \text{ N/mm}^2$
- A sufficient redundancy has to be ensured, that the failure of a single fastening will not lead to collapse of the entire system.
- Observance of all pre-drilling requirements



- For more details in relation to base material properties, please refer to the chapter **Fastener selection guide** in the Direct Fastening Manual (DFTM).

Arrangements to reduce or prevent moment on shank

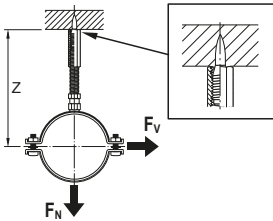

Application recommendation

Base material thickness

Concrete – DX-Kwik

$h_{\min} = 100 \text{ mm}$

Steel

$t_{II} \geq 6 \text{ mm}$

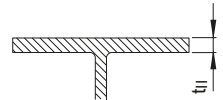

Fastened material thickness

X-CR M8

$t_I \leq L_g - t_{\text{washer}} - t_{\text{nut}} \cong \text{up to } 13.0 \text{ mm}$

Fastener positioning in base material for fastening to steel

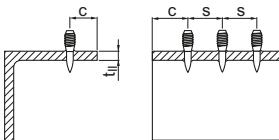

Edge distance:

$c \geq 15 \text{ mm}$

Spacing:

$s \geq 15 \text{ mm}$

Fastener positioning in base material for fastening to concrete

Pairs

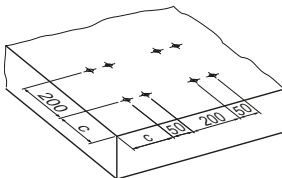

Reinforced * Non-reinforced

c 100 mm 150 mm

Row along edge

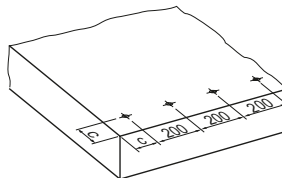

Reinforced * Non-reinforced

c 80 mm 150 mm

General (e.g. group of fasteners)

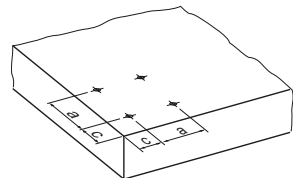

Reinforced * Non-reinforced

c 80 mm 150 mm

a 80 mm 100 mm

* Minimum $\phi 6$ reinforcing steel continuous along all edges and around all corners. Edge bars must be enclosed by stirrups

Application limits for fastening to concrete

No general restrictions existent. Limitations are dependent on application and user requirements.

Application limits for fastening to steel

Tool type: DX 76, DX 76 PTR

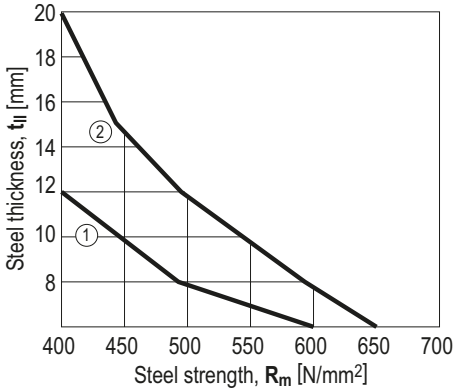

- ① X-CRM8-15-12 FP10 / DX 76 (impact)
- ② X-CRM8-15-12 FP10 / DX 76 (co-acting)

Corrosion information

- For fastenings exposed to weather or other corrosive conditions.
- Not for use in highly corrosive surroundings like swimming pools or highway tunnels.
- For more details, please refer to following technical document: Hilti Corrosion Handbook.

System recommendation

- For more details, please refer to the chapter **Accessories and consumables compatibility** in the Direct Fastening Technology Manual (DFTM).

Cartridge recommendation

Base material	Cartridge color (tool power level)	
	Tool type: DX 6 F8	Tool type: DX 5 F8, DX 460 F8, DX 351 F8, DX 2
	Cartridge type: 6.8/11 M	Cartridge type: 6.8/11 M
Soft/medium concrete	titanium ■ (2-6)	yellow ■, red ■
Tough concrete	titanium ■ (4-8)	yellow ■, red ■

Cartridge recommendation

Base material		Cartridge color (tool power level)		
		Tool type: DX 6 F8	Tool type: DX 5 F8, DX 460 F8	Tool type: DX 76 PTR
		Cartridge type: 6.8/11 M	Cartridge type: 6.8/11 M	Cartridge type: 6.8/18 M
S235, S275, S355	$6 \leq t_{II} \leq 20 \text{ mm}$	titanium ■ (4-8)	red ■	yellow ■ , red ■

- Tool power level adjustment by setting tests on site.
- Start tool energy selection with lowest recommended tool power level.
- Correct according requirement from chapter quality assurance.

Quality assurance

Fastening inspection

Fastening to concrete

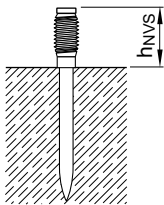

DX-Kwik (pre-drilling)

Fastener	h_{NVS} [mm]
X-CR M8-14-42 P8	12.0 – 16.0
X-CR M8-22-42 P8	20.0 – 24.0

Fastening to steel

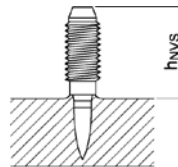

Fastener	h_{NVS} [mm]
X-CR M8-9-12 FP10	12.0 – 15.0
X-CR M8-15-12 FP10	17.0 – 20.0

Installation

Fastening to concrete

DX-Kwik (pre-drilling)

X-CR M8-__-42 P8

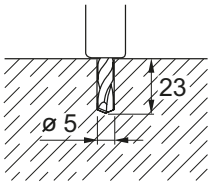

Pre-drill with drill bit
TE-C-5/23B (Item-no.
28557) or TE-C-5/23
(Item no. 00061787)

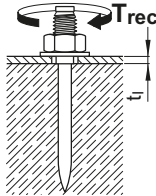

Tightening torque
 $T_{rec} = 10 \text{ Nm}$

Fastening to steel

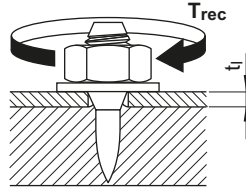

Tightening torque
X-CR M8 $T_{rec} = 8.5 \text{ Nm}$

These are abbreviated instructions which may vary by application.

ALWAYS review/follow the instructions accompanying the product.

Fastener program

For base material concrete, DX-Kwik method

Fastened thickness $t_{l,max}$	Fastener Designation ¹⁾	Item no.	L_g	L_s	Tools
5.0 mm	X-CR M8-14-42 P8	255911	14 mm	42 mm	DX 6 F8, DX 5 F8, DX 460 F8, DX 36, DX 2
13.0 mm	X-CR M8-22-42 P8	255910	22 mm	42 mm	

For base material steel

Fastened thickness $t_{l,max}$	Fastener Designation ¹⁾	Item no.	L_g	L_s	Tools
6.0 mm	X-CR M8-9-12 FP10	372032	9 mm	12.5 mm	DX 6 F10, DX 5 F10, DX 460 F10, DX 76, DX 76 PTR
6.0 mm	X-CR M8-15-12 FP10	372 034	15 mm	12.5 mm	

¹⁾ Type threading: M = metric

X-BT-ER Stainless steel threaded stud for electrical connection

Product data

Dimensions

X-BT-ER M10/7 SN 8
X-BT-ER W10/7 SN 8

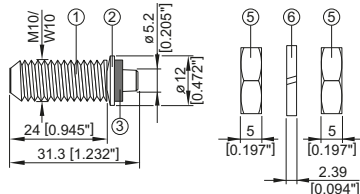

X-BT-ER M8/7 SN 8

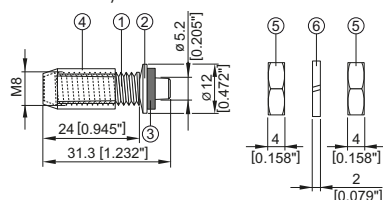

X-BT-ER M6/3 SN 8
X-BT-ER W6/3 SN 8

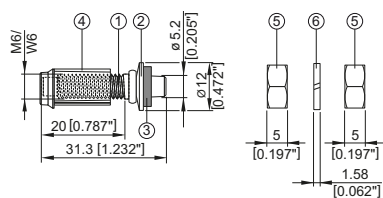

Material specifications

- ① Shank and thread: S31803 (1.4462) at least equivalent to A4 / AISI grade 316 material
- ② SN washer: S 31635 (X2CrNiMo 17-12-2, 1.4404)
- ③ Sealing washer: Elastomer, black, resistant to UV, salt water, water, ozone, oils, etc.
- ④ Guided sleeve: Plastic
- ⑤ Nut: A4 / AISI grade 316 material
- ⑥ Lock washer: A4 / AISI grade 316 material

Recommended fastening tools

BX 3-BT, DX 351-BT

- For more details, please refer to **X-BT-ER fastener program** and to the chapter **Accessories and consumables compatibility** in the Direct Fastening Technology Manual (DFTM).

Approvals for X-BT-ER stainless steel threaded studs for electrical connections

ABS 18-HS1755518, DNV-GL TAS00001 SV, BV 54554, LR 19/0003, UL-file E257067

- Not all information presented in this product data sheet might be subject to approval/certificate content. Please refer to approval/certificate for further information.

Applications

Examples

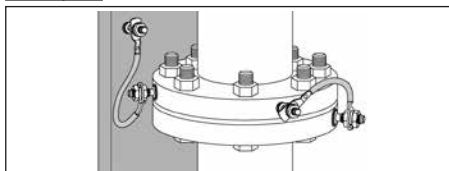

Functional and protective bonding in pipe
(Outer diameter of installed surface ≥ 150 mm)

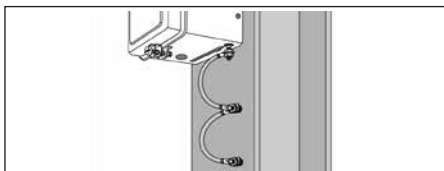

Protective bonding circuit - Double point connection

Performance data

Functional bonding and terminal connection in a circuit

For low permanent current due to static charge built up in pipes or for low permanent current when closing an electrical circuit

Single point connection

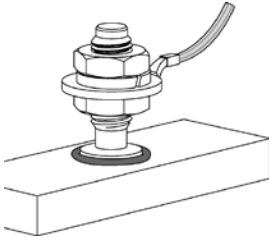

Recommended electrical connectors:

X-BT-ER M10/7 SN 8

X-BT-ER W10/7 SN 8

X-BT-ER M8/7 SN 8

X-BT-ER M6/3 SN 8, X-BT-ER M6/7 SN 8

X-BT-ER W6/3 SN 8, X-BT-ER W6/7 SN 8

Maximum allowable permanent current = 40 A

Note:

- Recommended connected cable size (tested to 40 A) according to IEC/EN 60204-1: $\leq 10 \text{ mm}^2$ copper ($\leq 8 \text{ AWG}$). Fastening of thicker cable is acceptable provided the maximum permanent current of 40 A is not exceeded and the provisions on cable lug thickness are observed.

Protective bonding circuit

For discharging short circuit current while protecting electrical equipment or earth / ground or bonded cable trays and ladders

Single point connection

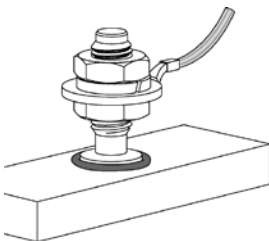

Recommended electrical connectors:

X-BT-ER M10/7 SN 8

X-BT-ER W10/7 SN 8

X-BT-ER M8/7 SN 8

X-BT-ER M6/3 SN 8, X-BT-ER M6/7 SN 8

X-BT-ER W6/3 SN 8, X-BT-ER W6/7 SN 8

Max. short circuit current for period of 1 s = 1250 A

Note:

- Recommended connected cable size (tested to 1250 A for 1 s) following IEC/EN 60947-7-2: $\leq 10 \text{ mm}^2$ copper ($\leq 8 \text{ AWG}$). Fastening of thicker cable is acceptable provided the maximum current of 1250 A for a period of 1 second is not exceeded and the provisions on cable lug thickness are observed.
- Recommended connected cable size (tested to 750 A for 4 s) according to UL 467: $\leq 10 \text{ AWG}$

Double point connection

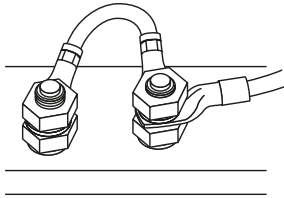

Recommended electrical connectors:

- X-BT-ER M10/7 SN 8
- X-BT-ER W10/7 SN 8
- X-BT-ER M8/7 SN 8
- X-BT-ER M6/7 SN 8
- X-BT-ER W6/7 SN 8

Max. short circuit current for period of 1 s = 1800 A

Note:

- Recommended connected cable size (tested to 1800 A for 1 s) following IEC/EN 60947-7-2: $\leq 16 \text{ mm}^2$ copper ($\leq 6 \text{ AWG}$). Fastening of thicker cable is acceptable provided the maximum current of 1800 A for a period of 1 second is not exceeded and the provisions on cable lug thickness are observed.

Lightning protection

For high temporary current due to lightning.

Single point connection

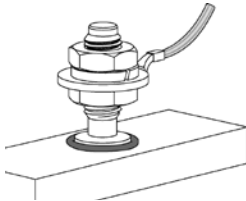

Recommended electrical connectors:

- X-BT-ER M10/7 SN 8
- X-BT-ER W10/7 SN 8
- X-BT-ER M8/7 SN 8
- X-BT-ER M6/3 SN 8, X-BT-ER M6/7 SN 8
- X-BT-ER W6/3 SN 8, X-BT-ER W6/7 SN 8

Maximum test current (according to EN 62561-1):
 $\leq 50 \text{ kA}$ for 2 ms

- When one nut is utilized and cable lug is in contact with base material.
- Cable lug must be in direct contact with non-coated base material.
- Extra M10/W10 stainless steel washer to be used and installed between lock washer and cable lug.
- Base material must not contact the X-BT-ER SN washer, lock washer and nut.
- Cable lug thickness = 2 mm to 12 mm. Cable lug hole diameter $\geq 14 \text{ mm}$.
- Max. tightening torque = 20 Nm.

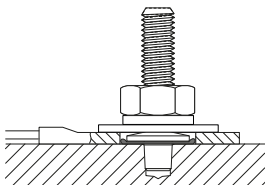

Recommended electrical connectors:

- X-BT-ER M10/7 SN 8
- X-BT-ER W10/7 SN 8
- X-BT-ER M8/7 SN 8
- X-BT-ER M6/3 SN 8, X-BT-ER M6/7 SN 8
- X-BT-ER W6/3 SN 8, X-BT-ER W6/7 SN 8

Maximum test current:
 $\leq 100 \text{ kA}$ for 2 ms

Application recommendation

Thickness of base material

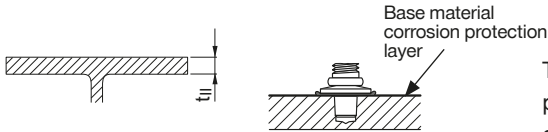

Thickness of base material corrosion protection layer ≤ 0.4 mm. For thicker coatings, please contact Hilti.

Thickness of cable lug

X-BT-ER M8/M10/W10
X-BT-ER M6/W6 /7 SN 8

X-BT-ER M6/W6 /3 SN 8

$t_{cl} \leq 7$ mm (0.28")

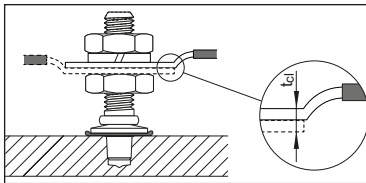

$t_{cl} \leq 3$ mm (0.12")

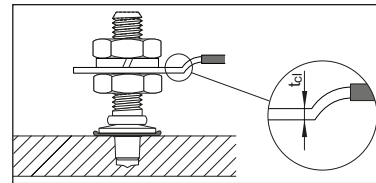

Spacing and edge distances

Edge distance:

$c \geq 6$ mm

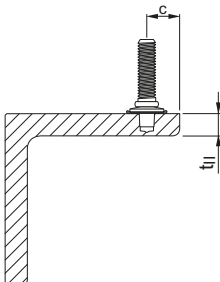

Spacing:

$s \geq 15$ mm

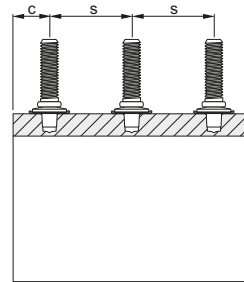

Application limit

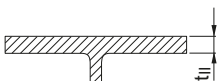

- $t_{B1} \geq 8$ mm [5/16"] no through penetration
- $t_{B1} \geq 6$ mm for through penetration
- No limits with regards to steel strength

Corrosion information

The corrosion resistance of Hilti CR500 and S31803 stainless steel material is equivalent to AISI 316 (A4) steel grade.

Fastener program and system recommendation BX 3-BT

Fastener program

Designation	Item no.	Tool designation	Fastener Guide designation
X-BT-ER M10/7 SN 8	2194352	BX 3-BT	X-FG B3-BT M
X-BT-ER M8/7 SN 8	2194351	BX 3-BT	X-FG B3-BT M
X-BT-ER M6/3 SN 8	2252195	BX 3-BT	X-FG B3-BT M
X-BT-ER W10/7 SN 8	2194353	BX 3-BT	X-FG B3-BT W
X-BT-ER W6/3 SN 8	2252198	BX 3-BT	X-FG B3-BT W

Fastener program and system recommendation DX 351-BT

Fastener program

Designation	Item no.	Tool designation	Fastener Guide designation
X-BT-ER M10/7 SN 8	2194352	DX 351-BT	BT FG M1024
X-BT-ER M8/7 SN 8	2194351	DX 351-BT	BT FG M1024
X-BT-ER M6/3 SN 8	2252195	DX 351-BT	BT FG M1024
X-BT-ER M6/7 SN 8	2194349	DX 351-BT	BT FG M1024
X-BT-ER W10/7 SN 8	2194353	DX 351-BT	BT FG W1024
X-BT-ER W6/3 SN 8	2252198	DX 351-BT	BT FG W1024
X-BT-ER W6/7 SN 8	2194350	DX 351-BT	BT FG W1024

Cartridge selection and tool energy setting

6.8/11 M high precision brown cartridge

- Tool power level adjustment by setting tests on site.
- Start tool energy selection with lowest recommended tool power level.
- Correct according requirement from chapter quality assurance.

Quality assurance

Fastening inspection

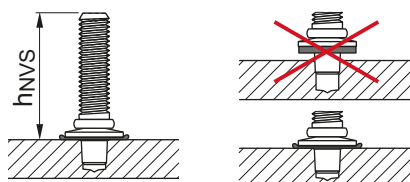

X-BT-ER M/W10, X-BT-ER M8 and
X-BT-ER M/W6

$h_{NVS} = 25.7-26.8 \text{ mm}$
 $= 1.01''-1.055''$

Installation for electrical connections

Single point connection for all X-BT-ER

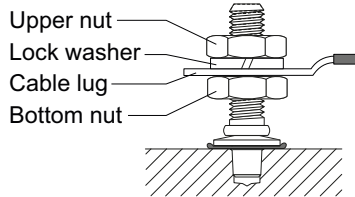
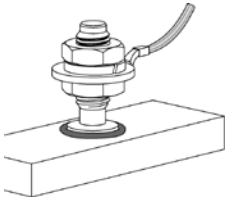

Double point connection only for X-BT-ER M6/W6 and X-BT-ER M8

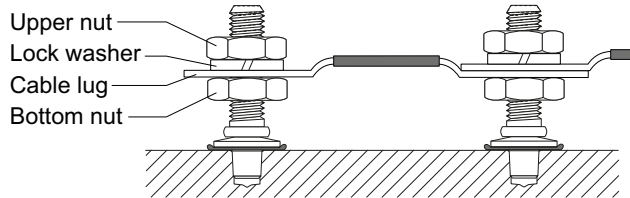
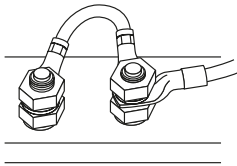

Torque recommendation for X-BT-ER

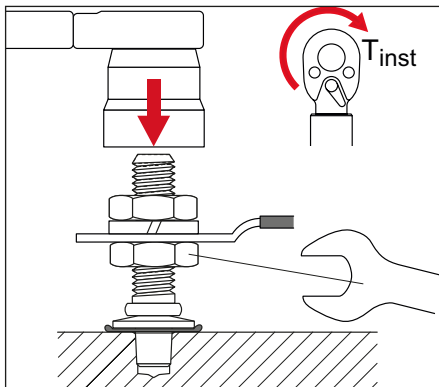

Hold the bottom nut with a spanner while tightening the upper nut.

Tightening torque:

$$T_{inst} = 8 - 20 \text{ Nm}$$

These are abbreviated instructions which may vary by application.
ALWAYS review/follow the instructions accompanying the product.

S-BT-ER (HC) and S-BT-EF (HC) screw-in stainless steel and carbon steel threaded studs for electrical connections

Product data

Dimensions

S-BT-ER M 10/15 SN6
 S-BT-ER W 10/15 SN6
 S-BT-EF M 10/15 AN6
 S-BT-EF W 10/15 AN6

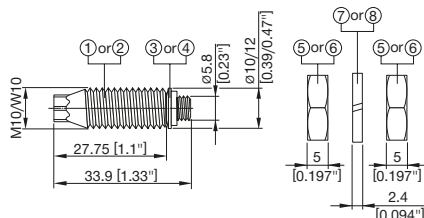

S-BT-ER M 8/15 SN6
 S-BT-EF M 8/15 SN6

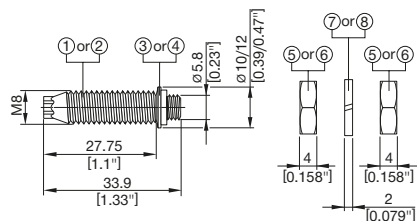

S-BT-ER M 10 HC 120
 S-BT-ER W 10 HC AWG4/0
 S-BT-EF M 10 HC 120
 S-BT-EF W 10 HC AWG4/0

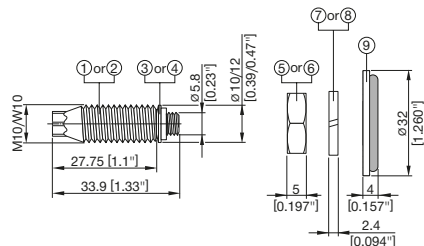

Material specifications

- ① Threaded shank: Stainless steel (S-BT-ER) "S 31803 (1.4462)" zinc-coated
- ② Threaded shank: Carbon steel (S-BT-EF) "1038 / duplex-coated"
- ③ SN12-R washers: Ø 12 mm [0.47"]
 Stainless steel (S-BT-ER) "S 31603 (1.4404)"
- ④ AN10-F washers: Ø 10 mm [0.39"]
 Aluminum (S-BT-EF)
- ⑤ Nut: Stainless steel (S-BT-ER) grade A4 / AISI 316 material
 Carbon steel (S-BT-EF) HDG
- ⑦ Lock washer: Stainless steel (S-BT-ER) grade A4 / AISI 316 material
 Carbon steel (S-BT-EF) HDG
- ⑧ Lock washer: Carbon steel (S-BT-EF) HDG
- ⑨ Conductivity disc: Ø 32 mm [1.260"]
 Copper alloy CuSn8 (tin-coated) with sealing ring

- Sealing ring:
 Sealing washers: Chloroprene rubber CR3.1107, black, resistant to UV, salt water, water, ozone, oils etc.
- Conductivity discs: FKM, Resistant to UV, salt water, water, ozone, oils, etc.

Recommended fastening tool

Refer to section "Fastener selection and system recommendation" for more details.

Listings and type approvals



Applications

Examples

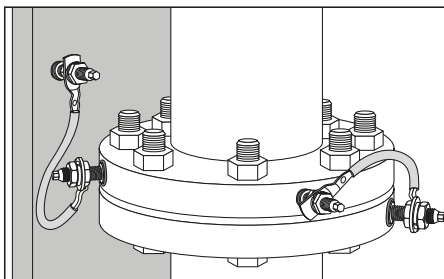

Functional and protective bonding of pipes *)
(outer diameter of installed surface ≥ 150 mm)
 *) only for Type A cable connections

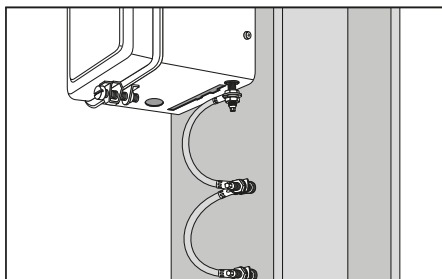

Protective bonding circuit - Double point connection

Functional bonding and terminal connection in a circuit

For permanent current (leakage current) due to static charge built up in pipes or when closing an electrical circuit.

Single point connection

	Recommended electrical connectors:	Maximum allowable permanent current
Type A	S-BT-ER M10/15 SN 6 S-BT-ER W10/15 SN 6 S-BT-EF M10/15 AN 6 S-BT-EF W10/15 AN 6 S-BT-ER M8/15 SN 6 S-BT-EF M8/15 AN 6	$I_{th} = 57$ A
Type B	S-BT-ER M10 HC 120 S-BT-ER W10 HC AWG4/0 S-BT-EF M10 HC 120 S-BT-EF W10 HC AWG4/0	$I_{th} = 269$ A

Note:

- Recommended maximal cross section of connected cable according IEC 60947-7-2 and IEC 60947-7-1:
 10 mm² (8 AWG) copper (tested permanent current $I_{th} = 57$ A)
 120 mm² (4/0 AWG) copper (tested permanent current $I_{th} = 269$ A)
- Fastening of thicker cable is acceptable, if the maximum allowable permanent current I_{th} is not exceeded and the provisions on cable lug thickness t_{cl} are observed.

Protective bonding circuit

For discharging short circuit current while protecting electrical equipment or earth/ground cable trays and ladders.

Single point connection

Type A

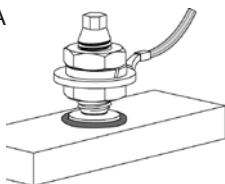

Recommended electrical connectors:

S-BT-ER M10/15 SN 6
 S-BT-ER W10/15 SN 6
 S-BT-EF M10/15 AN 6
 S-BT-EF W10/15 AN 6
 S-BT-ER M8/15 SN 6
 S-BT-EF M8/15 AN 6

Max. short circuit current according to IEC and UL

$I_{cw} = 1.20 \text{ kA}$ (IEC)

$I_{cw} = 0.75 \text{ kA}$ (UL)

Type B

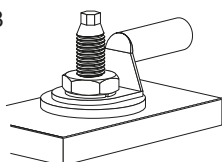

S-BT-ER M10 HC 120
 S-BT-ER W10 HC AWG4/0
 S-BT-EF M10 HC 120
 S-BT-EF W10 HC AWG4/0

$I_{cw} = 14.40 \text{ kA}$ (IEC)

$I_{cw} = 10.10 \text{ kA}$ (UL)

Note:

- Recommended maximal cross section of connected cable according IEC 60947-7-2 and IEC 60947-7-1:
 10 mm² (8 AWG) copper (tested short circuit current $I_{cw} = 1.20 \text{ kA}$ for 1 s)
 120 mm² (4/0 AWG) copper (tested short circuit current $I_{cw} = 14.40 \text{ kA}$ for 1 s) according UL 467:
 10 AWG copper (tested short circuit current $I_{cw} = 0.75 \text{ kA}$ for 4 s)
 4/0 AWG copper (tested short circuit current $I_{cw} = 10.10 \text{ kA}$ for 9 s)
- Fastening of thicker cable is acceptable, if the maximum short circuit current I_{cw} and the exposure time is not exceeded and the provisions on cable lug thickness t_{cl} are observed.

Double point connection

Type A

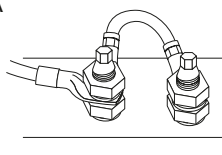

Recommended electrical connectors:

S-BT-ER M10/15 SN 6
 S-BT-ER W10/15 SN 6
 S-BT-EF M10/15 AN 6
 S-BT-EF W10/15 AN 6
 S-BT-ER M8/15 SN 6
 S-BT-EF M8/15 AN 6

Max. short circuit current according to IEC

$I_{cw} = 1.92 \text{ kA}$ (IEC)

Note:

- Recommended maximal cross section of connected cable according IEC 60947-7-2 and IEC 60947-7-1:
16 mm² (6 AWG) copper (tested short circuit current $I_{cw} = 1.92$ kA for 1 s)
- Fastening of thicker cable is acceptable, if the maximum short circuit current I_{cw} and the exposure time is not exceeded and the provisions on cable lug thickness t_{cl} are observed.

Lightning protection

For high temporary current due to lightning.

Single point connection

Classification N
(acc. IEC 62561-1)

Recommended electrical
connectors:

Maximum lightning current

Type A

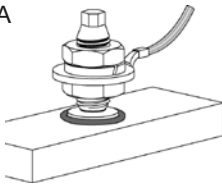

S-BT-ER M10/15 SN 6
S-BT-ER W10/15 SN 6
S-BT-EF M10/15 AN 6
S-BT-EF W10/15 AN 6
S-BT-ER M8/15 SN 6
S-BT-EF M8/15 AN 6

$I_{imp} = 50$ kA for ≤ 5 ms
(according to IEC 62561-1)

Type B

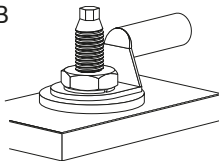

S-BT-ER M10 HC 120
S-BT-ER W10 HC AWG4/0
S-BT-EF M10 HC 120
S-BT-EF W10 HC AWG4/0

Classification H
(acc. IEC 62561-1)

Recommended electrical
connectors:

Type B

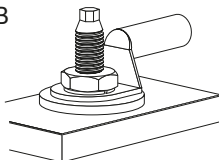

S-BT-ER M10 HC 120
S-BT-ER W10 HC AWG4/0
S-BT-EF M10 HC 120
S-BT-EF W10 HC AWG4/0

$I_{imp} = 100$ kA for ≤ 5 ms
(according to IEC 62561-1)

Note:

- When S-BT-ER/-EF is used in class H applications only type B cable connection is allowed.
- Tightening torque of 8 Nm must be observed accurately for type B cable connection.

Application Requirements

Base material thickness $t_{II} \geq 6 \text{ mm}^*)$

Thickness of base material corrosion protection layer $\leq 0.8 \text{ mm}$ [0.0315"].

For single point connection type B conductivity disc must be in direct contact with non-coated base material.

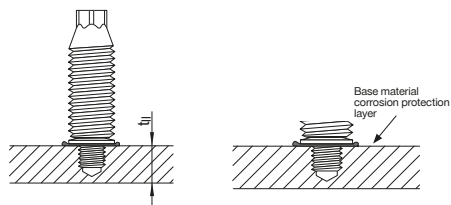

*) for the applications "Functional bonding and terminal connection in a circuit" and "Protective bonding circuit" the minimum base material thicknesses can be reduced to $t_{II} = 3 \text{ mm}$. Applicable only for Type A, single point connections.

In case of a drill through hole or a pilot hole in thin base material, rework of the coating on the back side of the plate/profile may be needed.

Cable lug characteristics and connector types

Cable lug thickness t_{cl} and inner hole diameter d_2

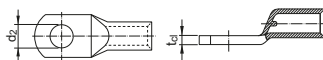

Fastener	Single point connector				Double point connector	
	Type A		Type B		Type A	
	t_{cl} [mm]	d_2 [mm]	t_{cl} [mm]	d_2 [mm]	t_{cl} [mm]	d_2 [mm]
S-BT-ER M10/15 SN 6	≤ 7	10.5			≤ 7	10.5
S-BT-ER W10/15 SN 6	≤ 7	10.5			≤ 7	10.5
S-BT-EF M10/15 AN 6	≤ 7	10.5			≤ 7	10.5
S-BT-EF W10/15 AN 6	≤ 7	10.5			≤ 7	10.5
S-BT-ER M8/15 SN 6	≤ 7	8.5			≤ 7	8.5
S-BT-EF M8/15 AN 6	≤ 7	8.5			≤ 7	8.5
S-BT-ER M10 HC 120			≤ 12	10.5		
S-BT-ER W10 HC AWG4/0			≤ 12	10.5		
S-BT-EF M10 HC 120			≤ 12	10.5		
S-BT-EF W10 HC AWG4/0			≤ 12	10.5		

Single point connector		Double point connector
Type A	Type B	Type A
<p>Diagram showing a Type A single point connector installed on a surface. A detail view shows a diameter of $\varnothing 7\text{mm}$.</p>	<p>Diagram showing a Type B single point connector installed on a surface.</p>	<p>Diagram showing a Type A double point connector installed on a surface. A detail view shows a diameter of $\varnothing 7\text{mm}$.</p>

Spacing & edge distances

Edge distance:

Type A connector: $\geq 6\text{ mm}$ [0.236"]

Type B connector: $\geq 20\text{ mm}$ [0.787"]

Spacing:

Type A connector: $\geq 22\text{ mm}$ [0.866"]

Type B connector: $\geq 40\text{ mm}$ [1.575"]

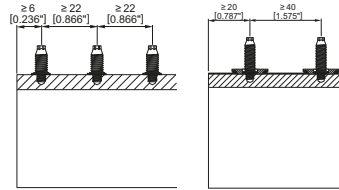
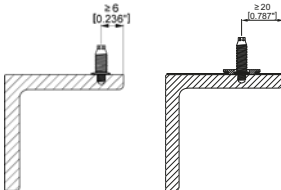

Installation temperature and service temperature

The installation temperature is the temperature at which the S-BT-ER/-EF studs are installed. A distinction is made between the temperature of the base material and the temperature of the S-BT-ER/-EF studs, drilling and installation tools and accessories. The installation temperature range can be found in the table below.

The service temperature is the temperature at which the S-BT-ER/-EF studs operate. The S-BT studs will operate effectively and without any loss in performance (loads, sealing function, etc.) within the specified service temperature range. Outside this temperature range the S-BT-ER/-EF studs may fail.

Designation	Installation temperature		Service temperature	
	min	max	min	max
Base material	-40 °C	+60 °C	-40 °C	+100 °C
S-BT-ER/-EF studs	-10 °C	+60 °C	-40 °C	+100 °C
Drilling & Installation tools and accessories	-10 °C	+60 °C	n.a.	n.a.

Note:

The service temperature range of the connected cable lugs and cables has to be observed. For details please contact the supplier of the cable lugs and cables.

Corrosion information

The S-BT-ER stainless steel fasteners are made from the duplex stainless steel type 1.4462, which is equivalent to AISI 316 (A4) steel grade. This grade of stainless steel is classified in the corrosion resistance class IV according to DIN EN 1993-1-4:2015, which makes the material suitable for aggressive environments like in coastal and offshore applications. The microstructures of duplex stainless steels consist of a mixture of austenite and ferrite phases. Compared to the austenitic stainless steel grades, duplex stainless steels are magnetic. The surface of the S-BT-ER stainless steel fasteners is zinc-coated (anti-friction coating) in order to reduce the thread forming torque when the stud is screwed in into the base material.

The coating of the carbon steel S-BT-EF fasteners consists of an electroplated Zn-alloy for cathodic protection and a top coat for chemical resistance (Duplex-coating). The thickness of the coating is 35 µm. This product is designed for use in corrosive categories C1, C2 and C3 according to the standard EN ISO 9223.

The conductivity disc of the S-BT-ER/-EF HC is made from copper alloy CuSn8 with a tin-coating on the surface and a sealing ring on the bottom side. The copper alloy is classified as largely insensitive to stress corrosion cracking and pitting corrosion.

The conductivity disc is designed for use in corrosion categories C1 – C5 according to EN ISO 9223. It is therefore suitable for use in aggressive environments like coastal and offshore applications.

To prevent corrosion of the base material due to the drilling process the following base material thickness t_{ll} has to be given.

	Fastener	
	Carbon steel S-BT-EF	Stainless steel S-BT-ER
Corrosivity category C Corrosion resistance class (CRC)	C1, C2, C3	CRC III, IV
Base material thickness t_{II} ¹⁾		
3 mm [0.12"] $\leq t_{II} < 6$ mm [0.24"] Pilot drill may cause damage to backside coating	✘ ²⁾	✘ ²⁾
6 mm [0.24"] $\leq t_{II} < 7$ mm [0.28"] Pilot drill may cause damage to backside coating	✓	✓ ³⁾
$t_{II} \geq 7$ mm [0.28"] Pilot drill will not affect backside of base material	✓	✓

¹⁾ Real base material thickness, not nominal material thickness or material thickness with coating.

²⁾ Damage of the coating on the back side of the plate/profile require a rework of the coating.

³⁾ Damage of the coating on the back side of the plate/profile require a rework of the coating, if the drilling tools SFBT 22-A or SFBT 18-A were used for drilling the bore hole. If the tool SBT 4-A22 was used for drilling the bore hole, no damage of the coating on the back side of the plate/profile will occur.

Application limit

The base material is limited to steel grade with a maximum tensile strength $f_u = 630$ MPa [91 ksi]. The minimum tensile strength of steel is $f_u \geq 340$ MPa [49 ksi].

Minimum thickness of base material t_{II} : refer to section "Application Requirements".

Maximum thickness of base material t_{II} : no limits.

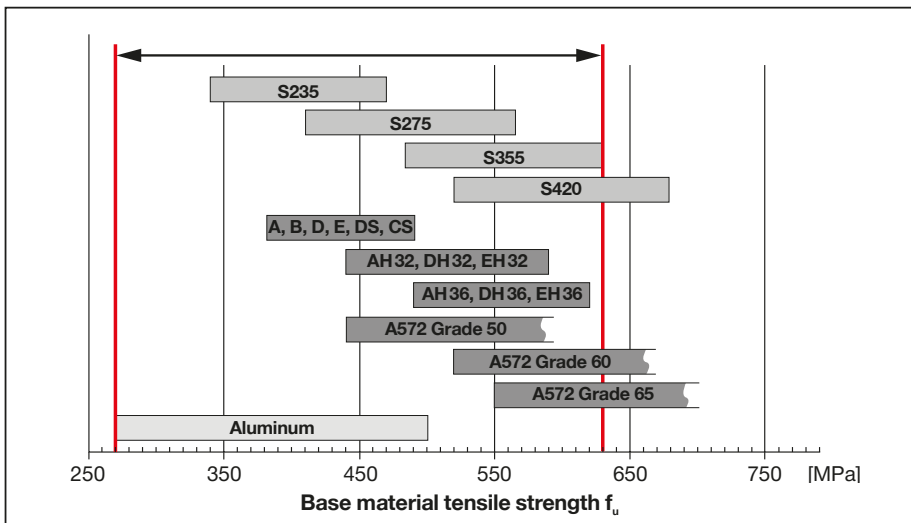

Fastener selection and system recommendation

Fasteners	Drilling tool	Stepped drill bit	Setting tool	Depth gauge
S-BT-ER M8/15 SN 6	SBT 4-A22 or SF BT 18-A or SF BT 22-A	TS-BT 5.5-74 S	SBT 4-A22 or SFC 18-A or SFC 22-A	S-DG BT M8/15 Long 6
S-BT-EF M8/15 AN 6				S-DG BT M10-W10/15 Long 6
S-BT-ER M10/15 SN 6				
S-BT-ER W10/15 SN 6				
S-BT-EF M10/15 AN 6				
S-BT-EF W10/15 AN 6				

Fasteners	Drilling tool	Stepped drill bit + coating removal drill bit	Setting tool	Depth gauge
S-BT-ER M10 HC 120	SBT 4-A22 or SF BT 18-A or SF BT 22-A	TS-BT 5.5-74 S TS-BT HC 120/ AWG4/0	SBT 4-A22 or SFC 18-A or SFC 22-A	S-DG BT M10-W10 HC 6
S-BT-ER W10 HC AWG4/0				
S-BT-EF M10 HC 120				
S-BT-EF W10 HC AWG4/0				

Fastener quality assurance

In order to ensure the exact screw-in depth and a proper compressed sealing washer, the S-BT-ER/-EF studs have to be installed with the appropriate depth gauge. With this tool the screw-in depth can be adjusted in a range of 0–1.5 mm (3 steps, 0.5mm per step).

The S-CC BT calibration card is needed to check the initial stand-off of the S-BT-ER/-EF stud and to adjust/calibrate the S-DG BT depth gauge. After finding the right adjustment level for the S-DG BT depth gauge, the gauge can be adjusted and the studs can be installed without additional check of the S-DG BT depth gauge.

The depth gauge has to be re-adjusted (calibrated) at following times:

- Start of the installation process
- Change of the working position (upwards, downwards, horizontal) and base material (thickness, strength, type)
- Installer change
- After each packaging respectively after the installation of 100 S-BT-ER / -EF studs

The lifetime of the S-DG BT depth gauge is ≥ 1000 settings.

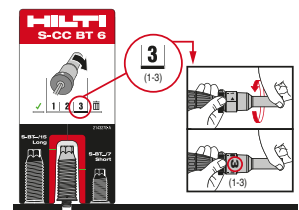
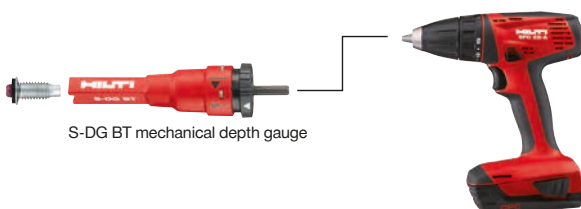

Design and functionality of the mechanical calibration card S-CC BT

Fastening inspection

The installer is responsible for the correct setting of the S-BT-ER / -EF studs.
 For the periodical verification of the correct stud stand-off the S-CG BT check gauge can be used.

Verify stud stand-off h_{NVS} with check gauge S-CG BT

$h_{NVS} = 29.3 \text{ mm to } 29.8 \text{ mm [1.153" to 1.173"]}$

- S-BT-ER M10/15 SN 6
- S-BT-ER W10/15 SN 6
- S-BT-EF M10/15 AN 6
- S-BT-EF W10/15 AN 6
- S-BT-ER M8/15 SN 6
- S-BT-EF M8/15 AN 6

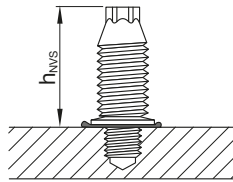

Design and functionality of the check gauge S-CG BT

$h_{NVS} = 26.10 \text{ mm to } 26.60 \text{ mm [1.028" to 1.047"]}$

- S-BT-ER M10 HC ____
- S-BT-ER W10 HC ____
- S-BT-EF M10 HC ____
- S-BT-EF W10 HC ____

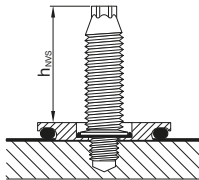

Designation	Product name	Comment
S-DG BT M8/15 Long 6	Depth gauge	for exact setting of S-BT-ER M8/15 SN 6, S-BT-EF M8/15 AN 6
S-DG BT M10-W10/15 Long 6	Depth gauge	for exact setting of S-BT-ER M10/15 SN 6, S-BT-ER W10/15 SN 6, S-BT-EF M10/15 AN 6, S-BT-EF W10/15 AN 6
S-DG BT M10-W10 HC 6	Depth gauge	for exact setting of S-BT-ER M10 HC ____, S-BT-ER W10 HC ____, S-BT-EF M10 HC ____, S-BT-EF W10 HC ____
S-CC BT 6	Calibration card	for calibration of the depth gauge for S-BT-ER and S-BT-EF
S-CC BT HC 6	Calibration card	for calibration of the depth gauge for S-BT-ER M10 HC ____, S-BT-ER W10 HC ____, S-BT-EF M10 HC ____, S-BT-EF W10 HC ____
S-CG BT/15 Long 6	Check gauge	for verification of the stand-off for S-BT-ER and S-BT-EF
S-CG BT HC	Check gauge	for verification of the stand-off for S-BT-ER M10 HC ____, S-BT-ER W10 HC ____, S-BT-EF M10 HC ____, S-BT-EF W10 HC ____

Installation

Single point connection

Single point connection type A:

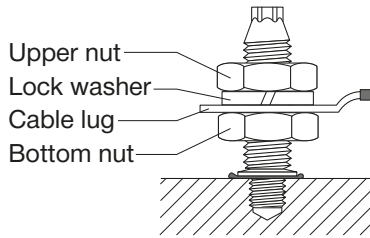
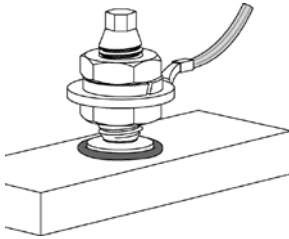

Single point connection type B:

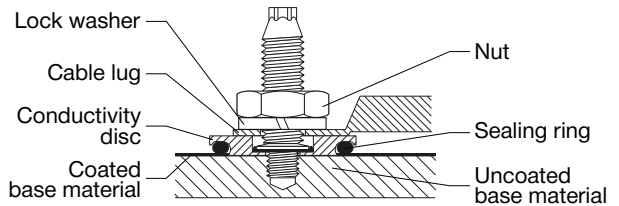
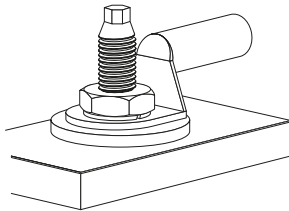

For Type B cable connection the following requirements have to be observed:

- The conductivity disc must be in direct contact with the non-coated base material. Coating has to be removed with the coating removal drill bit.
- Tightening torque of 8 Nm must be observed accurately.

Double point connection

Double point connection type A:

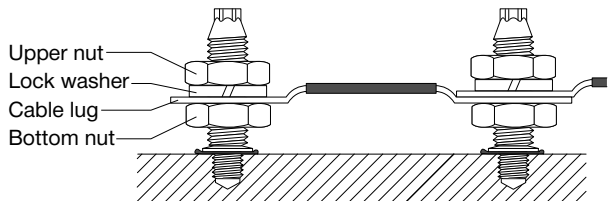
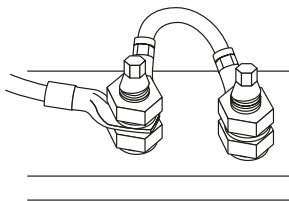

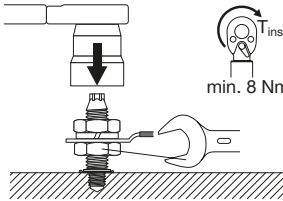
Torque recommendation for all S-BT-ER and S-BT-EF
Single point connection type A and double point connection type A:

Hold the bottom nut with a spanner while tightening the upper nut.

Tightening Torque: Min. 8 Nm
 Max. 20 Nm

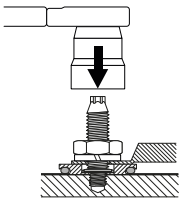
Single point connection type B:

The tightening torque is 8 Nm. Exceeding or falling below this tightening torque value is not allowed. Tighten the nut using torque tool X-BT 1/4" (8 Nm), torque wrench or Hilti screw driver SBT 4-A22, SFC 18-A, SFC 22-A (torque setting 5) with socket S-NS.

Important:

These are abbreviated instructions which may vary by application. ALWAYS review/follow the instructions for use (IFU) accompanying the product.

Fastener program

Designation	Item no.	Product name	Comment	Application
S-BT-EF M8/15 AN 6	2186208	Threaded stud	package includes nuts and lock washers	Electrical connection
S-BT-EF M10/15 AN 6	2186204	Threaded stud		
S-BT-EF W10/15 AN 6	2186206	Threaded stud		
S-BT-ER M8/15 SN 6	2186207	Threaded stud	package includes nuts and lock washers	Electrical connection
S-BT-ER M10/15 SN 6	2186203	Threaded stud		
S-BT-ER W10/15 SN 6	2186205	Threaded stud		
S-BT-ER M10 HC 120	2204739	Threaded stud	package includes nuts, lock washers and conductor discs	Electrical connection
S-BT-ER W10 HC AWG4/0	2206611	Threaded stud		
S-BT-EF M10 HC 120	2204932	Threaded stud	package includes nuts, lock washers and conductor discs	
S-BT-EF W10 HC AWG4/0	2206612	Threaded stud		
TS-BT 5.5-74 S	2143137	Stepped drill bit	for base material steel	
TS-BT HC 120/AWG4/0	2204736	Coating removal drill bit	for removal of the coating from the base material	
S-DG BT M10-W10/15 Long 6	2143261	Depth gauge	for exact setting of the S-BT	
S-DG BT M8/15 Long 6	2148575	Depth gauge	for exact setting of the S-BT	
S-DG BT M10-W10/15 HC 6	2204933	Depth gauge	for exact setting of the S-BT ____ HC ____	
S-CC BT 6	2143270	Calibration card	for calibration of the depth gauge	
S-CC BT HC 6	2204934	Calibration card	for calibration of the depth gauge	
X-BT 1/4" - 8 Nm	2119272	Torque tool	manual torque tool (8 Nm)	



Standoff adapters

Product data

Product description

Adapter M8-MR 25
 Adapter M8-MR 50
 Adapter M8-MR 75
 Adapter M8-MR 100
 Adapter M8-MF 25
 Adapter M8-MF 50
 Adapter M8-MF 75
 Adapter M8-MF 100



Adapter M10-MR 50
 Adapter M10-MF 50
 Adapter W10-MR 50
 Adapter W10-MF 50



- For fastenings on steel with passive fire protection (PFP) coating, bare steel members or insulated steel members
- Faster and more efficient – no welding/bracketing needed
- Helps to prevent contact between fixtures and steel beams or plates – both uncoated or PFP coated beams
- Versatile – threaded standoff adapters can be used as a spacer for a wide range of fastenings on PFP coated beams
- Wide M8 flange nut available for use with Hilti MQ strut channel

Fastening system

Adapter	Fastener		
	S-BT-GR M8/7 SN 6 S-BT-MR M8/7 SN 6	S-BT-GF M8/7 AN 6 S-BT-MF M8/7 AN 6	X-BT-GR M8/7 SN 8
Adapter M8-MR 25	■		■
Adapter M8-MR 50	■		■
Adapter M8-MR 75	■		■
Adapter M8-MR 100	■		■
Adapter M8-MF 25		■	■
Adapter M8-MF 50		■	■
Adapter M8-MF 75		■	■
Adapter M8-MF 100		■	■

Adapter	Fastener			
	S-BT-MR M10/15 SN 6	S-BT-MF M10/15 AN 6	S-BT-MR W10/15 SN 6	S-BT-MF W10/15 AN 6
Adapter M10-MR 50	■			
Adapter W10-MR 50			■	
Adapter M10-MF 50		■		
Adapter W10-MF 50				■

Adapter	Fastener	
	X-BT-MR M10/15 SN 8	X-BT-MR W10/15 SN 8
Adapter M10-MR 50	■	
Adapter W10-MR 50		■
Adapter M10-MF 50	■	
Adapter W10-MF 50		■

Material specification and material properties

Material specification and material properties for stainless steel parts

Designation	Material	Coating	Steel grade	Standard	Corrosion resistance acc. to EN 1993-1-4
Adapter M8-MR	Stainless steel	none	1.4401 316	EN 10088 ASTM, AISI, SAE	CRC III
Adapter M10-MR					
Adapter W10-MR					
Serrated flange nut M8	Stainless steel	none	A4-70	EN ISO 3506-2	CRC III
Serrated flange nut M10					

Material specification and material properties for carbon steel parts

Designation	Material	Coating	Steel grade	Standard	Corrosivity category acc. to EN ISO 9223
Adapter M8-MF	Carbon steel	electroplated Zn-alloy + top coat (Duplex coat.)	1.0737 12L14	EN 10277-3 ASTM, AISI, SAE	C1 – C3
Adapter M10-MF					
Adapter W10-MF					
Serrated flange nut M8	Carbon steel	HDG	Grade 8	EN ISO 898-2	C1 – C3
Serrated flange nut M10					

Product recommendation under various environmental conditions

Environmental condition		Fastener system	
		Adapter M8-MR Adapter M10-MR Adapter W10-MR combined with S-BT-GR M8/7 SN 6 S-BT-MR M8/7 SN 6 X-BT-GR M8/7 SN 8 S-BT-MR M10/15 SN 6 X-BT-MR M10/15 SN 8 S-BT-MR W10/15 SN 6 X-BT-MR W10/15 SN 8	Adapter M8-MF Adapter M10-MF Adapter W10-MF combined with S-BT-GF M8/7 AN 6 S-BT-MF M8/7 AN 6 S-BT-MF M10/15 AN 6 S-BT-MF W10/15 AN 6
	Dry indoor	■	■
	Indoor with temporary condensation	■	■
	Outdoor with low pollution	■	□
	Outdoor with moderate concentration of pollutants	■	□
	Coastal areas	■	-
	Outdoor, areas with heavy industrial pollution	■	-
	Close proximity to roads	■	-
	Special application	Please contact our Expert Hilti Engineers to support recommendation	
	Special application		

■ = Suitable for corrosion prevention

□ = Suitable, requires expert evaluation

Further information can be found in following Hilti brochures:

- X-BT Threaded Fastener Specification
- New Generation X-BT-GR, X-BT-MR and X-BT-ER Threaded Fastener Specification
- S-BT Threaded Fastener Specification

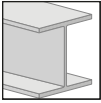
Base materials

Steel

Load condition



Static/quasi static

Approvals and certificates

- i** • Information presented in this product data sheet is based on Hilti Technical Data.
- Approvals / certificates available for following fastening systems:
S-BT threaded studs, X-BT threaded studs

Applications

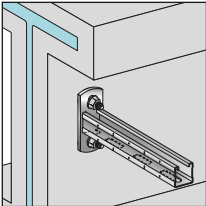
Fastening on steel with passive fire protection (PFP) coating

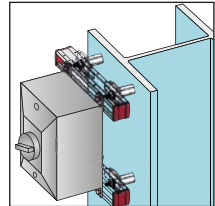
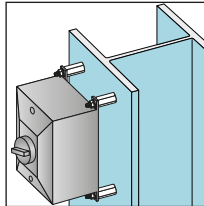

Fastening on bare steel members or insulated steel members

Dimensions

	Designation	L	L ₁	d ₁	d ₂	d ₃	AF
	Adapter M8-MR 25	46 mm	25 mm	acc. to M8	acc. to M8	14 mm	19 mm
	Adapter M8-MF 25						
	Adapter M8-MR 50	71 mm	50 mm	acc. to M8	acc. to M8	14 mm	19 mm
	Adapter M8-MF 50						
	Adapter M8-MR 75	96 mm	75 mm	acc. to M8	acc. to M8	14 mm	19 mm
	Adapter M8-MF 75						
	Adapter M8-MR 100	121 mm	100 mm	acc. to M8	acc. to M8	14 mm	19 mm
	Adapter M8-MF 100						
	Adapter M10-MR 50	71 mm	50 mm	acc. to M10	acc. to M10	14 mm	19 mm
	Adapter M10-MF 50						
	Adapter W10-MR 50	71 mm	50 mm	acc. to W10	acc. to W10	14 mm	19 mm
	Adapter W10-MF 50						

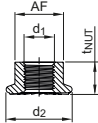
	Designation	t _{NUT}	d ₁	d ₂	AF
	Serrated flange nut M8	7.9 mm	acc. to M8	21.8 mm	13 mm
	Serrated flange nut M10	9.9 mm	acc. to M10	21.8 mm	15 mm
	Serrated flange nut W10	9.9 mm	acc. to W10	21.8 mm	9/16"

Performance data

Recommended interaction formula for combined loading

S-BT threaded studs with standoff adapter

$$V\text{-N (shear and tension)} \quad \frac{V}{V_{\text{rec}}} + \frac{N}{N_{\text{rec}}} \leq 1.0 \text{ with } \frac{V}{V_{\text{rec}}} \leq 1.0 \text{ and } \frac{N}{N_{\text{rec}}} \leq 1.0$$

X-BT threaded studs with standoff adapter

$$V\text{-N (shear and tension)} \quad \frac{V}{V_{\text{rec}}} + \frac{N}{N_{\text{rec}}} \leq 1.2 \text{ with } \frac{V}{V_{\text{rec}}} \leq 1.0 \text{ and } \frac{N}{N_{\text{rec}}} \leq 1.0$$

N_{rec} = Recommended resistance under tension

V_{rec} = Recommended resistance under shear load

N_{Rd} = Design resistance under tension load

V_{Rd} = Design resistance under shear load

Recommended loads

Base material thickness	S-BT-MR / S-BT-GR with standoff adapter made of stainless steel			
	t _{II} ≥ 5 mm [0.20"]		t _{II} = 4 mm [0.16"]	t _{II} = 3 mm [0.12"]
Base material type	Steel S235 A36	Steel S355, S420 Grade 50	Steel*) S235 A36	Steel*) S235 A36
Tension, N _{rec} Standoff Adapter 25, 50, 75, 100 mm	1.89 kN / 425 lb	2.27 kN / 510 lb	1.79 kN / 400 lb	1.79 kN / 400 lb
Shear, V _{rec} Standoff Adapter 25 mm	0.84 kN / 190 lb	1.00 kN / 225 lb	0.69 kN / 155 lb	0.55 kN / 125 lb
Shear, V _{rec} Standoff Adapter 50 mm	0.45 kN / 100 lb	0.54 / kN 120 lb	0.38 kN / 85 lb	0.31 kN / 70 lb
Shear, V _{rec} Standoff Adapter 75 mm	0.33 kN / 75 lb	0.40 kN / 90 lb	0.28 kN / 60 lb	0.24 kN / 55 lb
Shear, V _{rec} Standoff Adapter 100 mm	0.23 kN / 50 lb	0.28 kN / 60 lb	0.19 kN / 40 lb	0.18 kN / 40 lb

*) For steel base material of grade S355, S420, S390GD, S420GD, AH36, DH36, EH36 the values are allowed to be increased up to 20%

	S-BT-MF / S-BT-GF with standoff adapter made of duplex coated carbon steel			
Base material thickness	$t_{II} \geq 5 \text{ mm [0.20"]}$		$t_{II} = 4 \text{ mm [0.16"]}$	$t_{II} = 3 \text{ mm [0.12"]}$
Base material type	Steel S235 A36	Steel S355, S420 Grade 50	Steel*) S235 A36	Steel*) S235 A36
Tension, N_{rec} Standoff Adapter 25, 50, 75, 100 mm	1.96 kN / 440 lb	2.36 kN / 530 lb	1.89 kN / 425 lb	1.89 kN / 425 lb
Shear, V_{rec} Standoff Adapter 25 mm	0.84 kN / 190 lb	1.00 kN / 225 lb	0.69 kN / 155 lb	0.55 kN / 125 lb
Shear, V_{rec} Standoff Adapter 50 mm	0.45 kN / 100 lb	0.54 kN / 120 lb	0.38 kN / 85 lb	0.31 kN / 70 lb
Shear, V_{rec} Standoff Adapter 75 mm	0.33 kN / 75 lb	0.40 kN / 90 lb	0.28 kN / 60 lb	0.24 kN / 55 lb
Shear, V_{rec} Standoff Adapter 100 mm	0.23 kN / 50 lb	0.28 kN / 60 lb	0.19 kN / 40 lb	0.18 kN / 40 lb

*) For steel base material of grade S355, S420, S390GD, S420GD, AH36, DH36, EH36 the values are allowed to be increased up to 20%

	X-BT MR / X-BT GR with standoff adapter made of stainless steel or duplex coated carbon steel	
Base material thickness	$t_{II} \geq 8 \text{ mm [0.31"]}$	
Base material type	Steel S235, A36	Steel S355, S420, Grade 50
Tension, N_{rec} Standoff Adapter 25, 50, 75, 100 mm	3.60 kN / 810 lb	4.60 kN / 1035 lb
Shear, V_{rec} Standoff Adapter 25 mm	1.14 kN / 255 lb	1.43 kN / 320 lb
Shear, V_{rec} Standoff Adapter 50 mm	0.62 kN / 140 lb	0.78 kN / 175 lb
Shear, V_{rec} Standoff Adapter 75 mm	0.52 kN / 115 lb	0.65 kN / 145 lb
Shear, V_{rec} Standoff Adapter 100 mm	0.35 kN / 80 lb	0.44 kN / 100 lb

Design loads

	S-BT-MR / S-BT-GR with standoff adapter made of stainless steel			
Base material thickness	$t_{II} \geq 5 \text{ mm [0.20"]}$		$t_{II} = 4 \text{ mm [0.16"]}$	$t_{II} = 3 \text{ mm [0.12"]}$
Base material type	Steel S235 A36	Steel S355, S420 Grade 50	Steel*) S235 A36	Steel*) S235 A36
Tension, N_{Rd} Standoff Adapter 25, 50, 75, 100 mm	2.65 kN / 595 lb	3.18 kN / 715 lb	2.50 kN / 560 lb	2.50 kN / 560 lb
Shear, V_{Rd} Standoff Adapter 25 mm	1.17 kN / 260 lb	1.41 kN / 315 lb	0.96 kN / 215 lb	0.77 kN / 170 lb
Shear, V_{Rd} Standoff Adapter 50 mm	0.64 kN / 140 lb	0.76 kN / 170 lb	0.53 kN / 120 lb	0.43 kN / 95 lb
Shear, V_{Rd} Standoff Adapter 75 mm	0.47 kN / 105 lb	0.55 kN / 125 lb	0.39 kN / 90 lb	0.34 kN / 75 lb
Shear, V_{Rd} Standoff Adapter 100 mm	0.32 kN / 70 lb	0.39 kN / 90 lb	0.27 kN / 60 lb	0.25 kN / 55 lb

	S-BT-MF / S-BT-GF with standoff adapter made of duplex coated carbon steel			
Base material thickness	$t_{II} \geq 5 \text{ mm [0.20"]}$		$t_{II} = 4 \text{ mm [0.16"]}$	$t_{II} = 3 \text{ mm [0.12"]}$
Base material type	Steel S235 A36	Steel S355, S420 Grade 50	Steel*) S235 A36	Steel*) S235 A36
Tension, N_{Rd} Standoff Adapter 25, 50, 75, 100 mm	2.75 kN / 615 lb	3.30 kN / 740 lb	2.65 kN / 595 lb	2.65 kN / 595 lb
Shear, V_{Rd} Standoff Adapter 25 mm	1.17 kN / 260 lb	1.41 kN / 315 lb	0.96 kN / 215 lb	0.77 kN / 170 lb
Shear, V_{Rd} Standoff Adapter 50 mm	0.64 kN / 140 lb	0.76 kN / 170 lb	0.53 kN / 120 lb	0.43 kN / 95 lb
Shear, V_{Rd} Standoff Adapter 75 mm	0.47 kN / 105 lb	0.55 kN / 125 lb	0.39 kN / 90 lb	0.34 kN / 75 lb
Shear, V_{Rd} Standoff Adapter 100 mm	0.32 kN / 70 lb	0.39 kN / 90 lb	0.27 kN / 60 lb	0.25 kN / 55 lb

*) For steel base material of grade S355, S420, S390GD, S420GD, AH36, DH36, EH36 the values are allowed to be increased up to 20%

	X-BT MR / X-BT GR with standoff adapter made of stainless steel or duplex coated carbon steel	
Base material thickness	$t_{fl} \geq 8 \text{ mm [0.31"]}$	
Base material type	Steel S235, A36	Steel S355, S420, Grade 50
Tension, N_{Rd} Standoff Adapter 25, 50, 75, 100 mm	5.00 kN / 1120 lb	6.50 kN / 1460 lb
Shear, V_{Rd} Standoff Adapter 25 mm	1.60 kN / 360 lb	2.00 kN / 450 lb
Shear, V_{Rd} Standoff Adapter 50 mm	0.87 kN / 195 lb	1.09 kN / 245 lb
Shear, V_{Rd} Standoff Adapter 75 mm	0.73 kN / 165 lb	0.91 kN / 205 lb
Shear, V_{Rd} Standoff Adapter 100 mm	0.49 kN / 110 lb	0.61 kN / 135 lb

Conditions for recommended loads and design loads:

- The design resistance can be used for the design according the partial safety concept, e.g. EN 1993-1-1 (Eurocode 3).
- Global factor of safety Ω resp. partial factor of safety γ_m (based on 5% fractile ultimate test value)

	Recommended loads	Design loads
static pull-out	2.80	2.00
static shear	2.80	2.00

- For the shear resistance values a stand-off distance $Z_1 = 30 \text{ mm [1.18"]}$, 55 mm [2.16"] , 80 mm [3.15"] , 105 mm [4.13"] is considered.

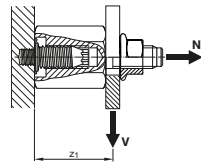

- Minimum edge distance = 15 mm [0.59"] , spacing $\geq 18 \text{ mm [0.709"]}$
- Effect of base metal vibration and stress (e.g. areas with tensile stress) considered.
- Redundancy (multiple fastening) must be provided.
- Maximum displacement in direction of the shear force $\leq 2.0 \text{ mm [0.08"]}$

Application recommendation

Base material

All requirements for the base material (type, strength, thickness, spacing and edge distances, application limits, etc.) are given in the Product Data Sheet (PDS) of the S-BT fastener and X-BT fastener.

Thickness of fastened material t_f

Adapter M8-MR and M8-MF: ≤ 9 mm [0.35"]

Adapter M10-MR and M10-MF: ≤ 7 mm [0.27"]

Adapter W10-MR and W10-MF: ≤ 7 mm [0.27"]

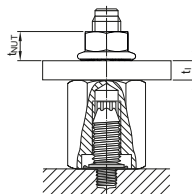

Fastener	Standoff adapter	Standoff length	
S-BT-GR M8/7 SN 6 S-BT-MR M8/7 SN 6 X-BT GR M8/7 SN 8	Stainless steel	Adapter M8-MR 25	25 mm [1"]
		Adapter M8-MR 50	50 mm [2"]
		Adapter M8-MR 75	75 mm [3"]
		Adapter M8-MR 100	100 mm [4"]
S-BT-GF M8/7 AN 6 S-BT-MF M8/7 AN 6 X-BT GR M8/7 SN 8	Carbon steel	Adapter M8-MF 25	25 mm [1"]
		Adapter M8-MF 50	50 mm [2"]
		Adapter M8-MF 75	75 mm [3"]
		Adapter M8-MF 100	100 mm [4"]
S-BT-MR M10/15 SN 6 X-BT-MR M10/15 SN 8	Stainless steel	Adapter M10-MR 50	50 mm [2"]
S-BT-MF M10/15 AN 6 X-BT-MR M10/15 SN 8	Carbon steel	Adapter M10-MF 50	50 mm [2"]
S-BT-MR W10/15 SN 6 X-BT-MR W10/15 SN 8	Stainless steel	Adapter W10-MR 50	50 mm [2"]
S-BT-MF W10/15 AN 6 X-BT-MR W10/15 SN 8	Carbon steel	Adapter W10-MF 50	50 mm [2"]

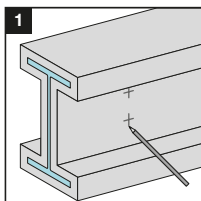
Installation recommendation
Fastening standoff adapter with S-BT or X-BT on PFP-coated steel

1
Mark location of each fastening.

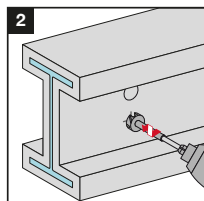

2
Remove PFP and pre-drill with stepped drill bit ...

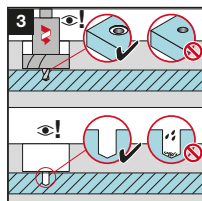

3
... until shoulder grinds a shiny ring. The drilled hole and the area around drilled hole must be clean and free from liquids and debris.

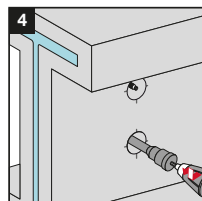

4
Set studs into drilled hole.

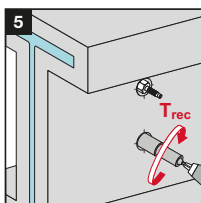

5
Screw-on the Hilti standoff adapter on the stud and tighten it with the recommended installation torque T_{rec} of 8 Nm.

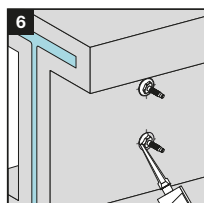

6
Close the opening within 4 hours of the opening is being made in accordance to the patching instructions by the PFP-manufacturer.

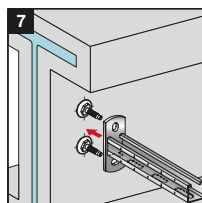

7
Position accessory on standoff adapter and hold in place. Use of MQZ bore plate as needed for strut applications.

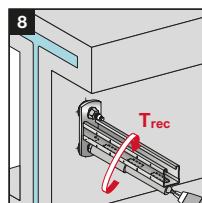

8
Fasten the accessory on the standoff adapter with the recommended installation torque T_{rec} of 20 Nm.

Important notes:

These are abbreviated instructions which may vary by application. ALWAYS review / follow the instructions for use (IFU) accompanying the product.

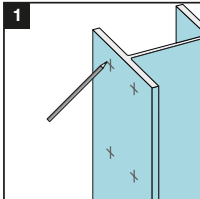
Fastening standoff adapter with S-BT or X-BT on bare steel members
Installation instructions

1
Mark location of each fastening.

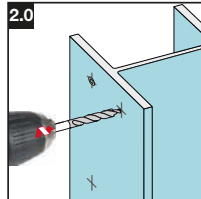

2.0
Pre-drill with stepped drill bit ...

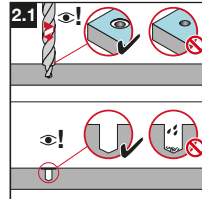

2.1
... until shoulder grinds a shiny ring. The drilled hole and the area around drilled hole must be clean and free from liquids and debris.

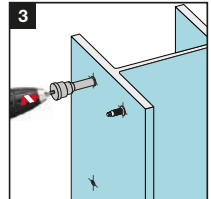

3
Set studs into drilled hole.

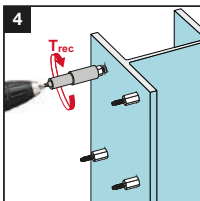

4
Screw-on the Hilti standoff adapter on the stud and tighten it with the recommended installation torque T_{rec} of 8 Nm.

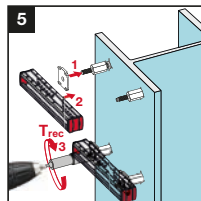

5
Position channel on standoff adapter and hold in place. Tighten the nuts with a tightening torque T_{rec} of 20 Nm.

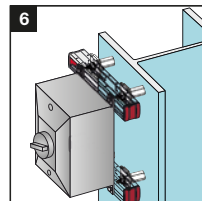

6
Fasten the accessory on the channel with the suited installation torque.

Important notes:

These are abbreviated instructions which may vary by application. ALWAYS review / follow the instructions for use (IFU) accompanying the product. In case of a drill through hole, rework of the coating on the back side of the plate / profile may be needed

Tightening torque for standoff adapter

	Fastener: X-BT-MR, S-BT-MR, S-BT-MF
Element: standoff adapter	8 Nm

Tightening tool recommendation for tightening with cordless screwdriver

Cordless screwdriver	Clutch type (stop detection)	Gear	Clutch
SF 4-A22	TRC	1	8
SF 6-A22	ESC (HJ)	1	7
SF 6H-A22	ESC (HJ)	1	7
SBT 4-A22	TRC	1	7



- Tool power level adjustment:

Gear:



Clutch:



- The setting of the torque via the Hilti screwdriver with torque release coupling (TRC) can change as the clutch wears over time. The specified torque setting is only a rough guide value and applies to a new Hilti screwdriver. To ensure recommended torque is applied, Hilti recommends the use of a calibrated torque wrench or the Hilti torque tool.
- The specified torque setting for the Hilti screw drivers with electronic slip clutch (ESC) is only a rough guide value as the ESC has 2 stop detections; Soft Joint (SJ) detection and Hard Joint (HJ) detection. The hard joint detection is activated due to drop in speed (fast stop) and can lead to a torque spike. The installation torque may vary depending on the user and the application. To ensure recommended torque is applied, Hilti recommends the use of a calibrated torque wrench or the Hilti torque tool.

Tightening tool recommendation for tightening with Hilti torque tool

Hilti torque tool

Torque tool X-BT 1/4" – 8 Nm

Tightening torque for upper flange nut

	Fastener: standoff adapter
Element: Upper flange nut	20 Nm

Tightening tool recommendation for tightening with cordless screwdriver

Cordless screwdriver	Clutch type (stop detection)	Gear	Clutch
SF 6-A22	ESC (HJ)	1	5
SF 6H-A22	ESC (HJ)	1	5



- Tool power level adjustment:

Gear:



Clutch:



- The setting of the torque via the Hilti screwdriver with torque release coupling (TRC) can change as the clutch wears over time. The specified torque setting is only a rough guide value and applies to a new Hilti screwdriver. To ensure recommended torque is applied, Hilti recommends the use of a calibrated torque wrench or the Hilti torque tool.
- The specified torque setting for the Hilti screw drivers with electronic slip clutch (ESC) is only a rough guide value as the ESC has 2 stop detections; Soft Joint (SJ) detection and Hard Joint (HJ) detection. The hard joint detection is activated due to drop in speed (fast stop) and can lead to a torque spike. The installation torque may vary depending on the user and the application. To ensure recommended torque is applied, Hilti recommends the use of a calibrated torque wrench or the Hilti torque tool.

Tightening tool recommendation for tightening with Hilti torque tool

Hilti torque tool
Torque tool X-BT 1/4" - 20 Nm

Fastener selection

Component	Designation	Item no.	Comment
Standoff adapter	Adapter M8-MF 25	2268526	M8: package includes serrated wide flange nut
Standoff adapter	Adapter M8-MF 50	2268527	
Standoff adapter	Adapter M8-MF 75	2268528	
Standoff adapter	Adapter M8-MF 100	2268529	
Standoff adapter	Adapter M8-MR 25	2268522	
Standoff adapter	Adapter M8-MR 50	2268523	
Standoff adapter	Adapter M8-MR 75	2268524	
Standoff adapter	Adapter M8-MR 100	2268525	
Standoff adapter	Adapter M10-MF 50	2281194	M10 / W10: package includes adapters only
Standoff adapter	Adapter M10-MR 50	2281193	
Standoff adapter	Adapter W10-MF 50	2281192	
Standoff adapter	Adapter W10-MR 50	2281191	
Threaded stud	S-BT-GF M8/7 AN 6	2140527	use with Adapter M8-MF
Threaded stud	S-BT-GR M8/7 SN 6	2140529	use with Adapter M8-MR
Threaded stud	S-BT-MF M10/15 AN 6	2140528	use with Adapter M10-MF
Threaded stud	S-BT-MF W10/15 AN 6	2139173	use with Adapter W10-MF
Threaded stud	S-BT-MR M10/15 SN 6	2140740	use with Adapter M10-MR
Threaded stud	S-BT-MR W10/15 SN 6	2140741	use with Adapter W10-MR
Threaded stud	X-BT-GR M8/7 SN 8	2194344	use with Adapter M8-MR or M8-MF
Threaded stud	X-BT-MR M10/15 SN 8	2194340	use with Adapter M10-MR or M10-MF
Threaded stud	X-BT-MR W10/15 SN 8	2194341	use with Adapter W10-MR or W10-MF
Stepped drill bit	TS-BT 31-74 PFP	2270470	for removal of the PFP-coating from the base material
Stepped drill bit	TX-BT 31-74 PFP	2310192	for removal of the PFP-coating from the base material
Stepped drill bit	TS-BT 5.5-74 S	2143137	for base material steel
Stepped drill bit	TX-BT 4.7/7-80	2197930	for base material steel
Depth gauge	S-DG BT M8/7 Short 6	2279735	for exact setting of the S-BT M8
Depth gauge	S-DG BT M10-W10/15 Long 6	2143261	for exact setting of the S-BT M10/W10
Calibration card	S-CC BT 6	2143270	for calibration of the depth gauge
Torque tool	X-BT 1/4" - 8 Nm	2119272	manual torque tool (8 Nm)
Torque tool	X-BT 1/4" - 20 Nm	2212510	manual torque tool (20 Nm)
Nut setter	S-NS 19 95/3 1/4"	2268521	for standoff adapter
Nut setter	S-NS 13 C 95/3 3/4"	2149244	for serrated flange nut M8
Nut setter	S-NS 15 C 95/3 1/4"	2149245	for serrated flange nut M10
Nut setter	S-NS 9/16" C 95/3 3/4"	2149246	for serrated flange nut W10

X-FCM Grating fastening system

Product data

Dimension

X-FCM

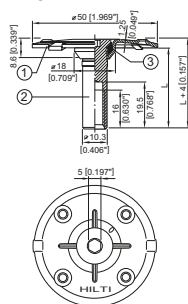

X-FCM-M_L

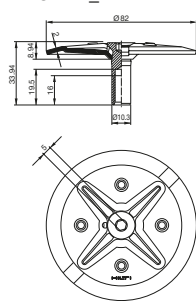

Material specification

- See material specification in the next pages.

Recommended fastening tool

- See system recommendation in the next pages.

Fastener dimensions

X-ST-GR M8/10 P8

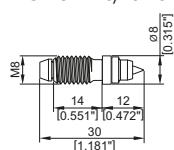

X-CRM8-15-12 FP10

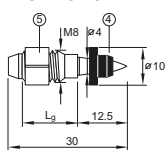

X-CRM8-15-12 P8

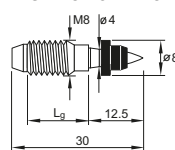

X-EM8H-15-12 FP10

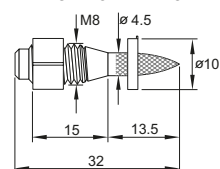

X-BT M8-15-6 SN12-R

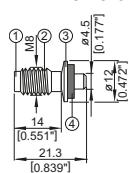

X-BT-GR M8/7 SN8

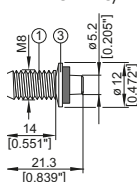

S-BT-GF M8/7 AN 6

S-BT-GR M8/7 SN 6

S-BT-GR M8/7 SN 6 AL

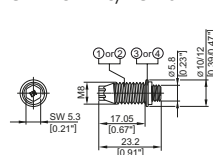

X-EM8H-15-12 P8

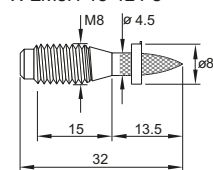

Approvals and certificates

- X-FCM-M, X-FCM-R: DNV GL, BV
- X-FCM, X-FCM-M, X-FCM-R: ABS, LR
- X-FCM-M_L: No approval
- Not all information presented in this product data sheet might be subject to approval/certificate content. Please refer to approval/certificate for further information.

Application

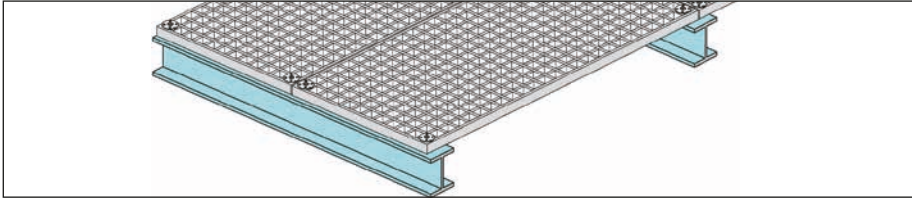

Example



Grating (steel and fibreglass reinforced)

Performance data

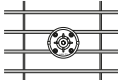
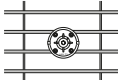
Recommended resistance under tensile load N_{rec}

Grating opening type	Rectangular		Square	
				
Bar spacing	18 mm	30 mm	18 mm	30 mm
X-FCM	0.8 kN ²⁾	0.8 kN ²⁾	2.4 kN ¹⁾³⁾	0.8 kN ²⁾
X-FCM-M	0.8 kN ²⁾	0.8 kN ²⁾	1.8 kN ¹⁾³⁾	0.8 kN ²⁾
X-FCM-R	1.4 kN ²⁾³⁾	1.0 kN ²⁾	1.8 kN ¹⁾³⁾	1.0 kN ²⁾
Bar spacing	30 mm	57 mm	30 mm	60 mm
X-FCM-M_L	0.8 kN ²⁾	0.8 kN ²⁾	1.8 kN ¹⁾³⁾	0.8 kN ²⁾

¹⁾ Loading is limited by recommended load for threaded stud.

²⁾ Loading is limited by elastic limit of the X-FCM disk. Exceeding recommended loads can result in plastic deformation of disk.

³⁾ S-BT-GR M8/7 SN 6 AL in aluminum base material: $N_{rec} = 1.0$ kN

S-BT-GR M8/7 SN 6 in steel base material $3 \text{ mm} \leq t_{II} < 5 \text{ mm}$ (drill through hole): $N_{rec} = 1.0$ kN

S-BT-GF M8/7 AN 6 in steel base material $3 \text{ mm} \leq t_{II} < 5 \text{ mm}$ (drill through hole): $N_{rec} = 1.0$ kN

S-BT-GR M8/7 SN 6, S-BT-GF M8/7 AN 6 in steel base material $t_{II} \geq 5 \text{ mm}$: $N_{rec} = 1.8$ kN

Note:

X-FCM, X-FCM-M, X-FCM-R, X-FCM-M_L resist shear by friction and are not suitable for explicit shear load designs, e.g. diaphragms. Depending on surface characteristics, shear loads of up to about 0.3 kN will not result in permanent deformation. Therefore small unexpected shear loads can generally be accommodated without damage.

Characteristic resistance under tension load N_{Rk}

Type	Bar spacing	X-FCM-R with		
		X-BT (X-BT-GR M8/7 SN 6 for $t_{ij} \geq 6$ mm) S235 / A36 steel	S355 / Grade 50 steel	X-CRM / X-ST-GR
	Rectangle 18 mm	4.2 kN/945 lb*	4.2 kN/945 lb*	4.2 kN/945 lb*
	Rectangle 30 mm	3.0 kN/675 lb*	3.0 kN/675 lb*	3.0 kN/675 lb*
	Square 18 mm	5.4 kN/1215 lb	6.9 kN/1550 lb	5.4 kN/1215 lb
	Square 30 mm	3.0 kN/ 675 lb*	3.0 kN/ 675 lb*	3.0 kN/ 675 lb*

* Loading is limited by elastic limit of the X-FCM-R disc.

Characteristic resistance under tension load N_{Rk}

Type	Bar spacing	X-FCM-R with		
		S-BT-GR M8/7 SN 6, pilot hole, $t_{ij} \geq 6$ mm S235 / A36 steel	S355 / Grade 50 steel	Aluminum $R_m \geq 270$ N/mm ²
	Rectangle 18 mm	4.2 kN/945 lb*	4.2 kN/945 lb*	3.0 kN/675 lb
	Rectangle 30 mm	3.0 kN/675 lb*	3.0 kN/675 lb*	3.0 kN/675 lb
	Square 18 mm	5.4 kN/1215 lb	6.9 kN/1550 lb	3.0 kN/675 lb
	Square 30 mm	3.0 kN/ 675 lb*	3.0 kN/ 675 lb*	3.0 kN/675 lb

* Loading is limited by elastic limit of the X-FCM-R disc.

Load displacement behaviour

Example:

Tensile load

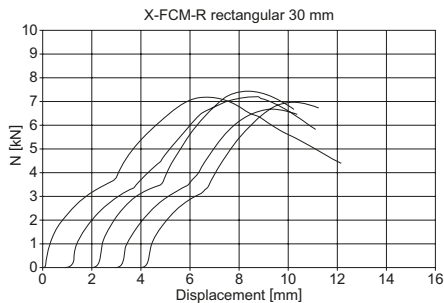

Shear load

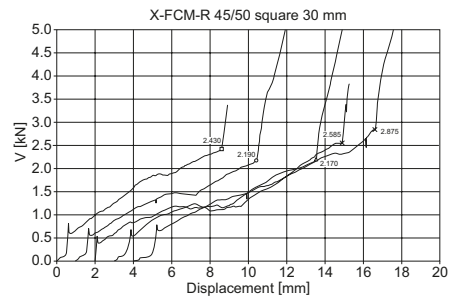

Application recommendation

Thickness of base material

X-BT

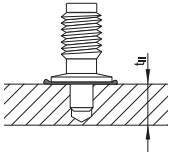

$t_{II} \geq 8 \text{ mm}$

S-BT-GF M8/7 AN 6
S-BT-GR M8/7 SN 6
S-BT-GR M8/7 SN 6 AL*)

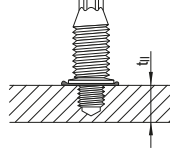

$t_{II} \geq 6 \text{ mm}$
pilot hole

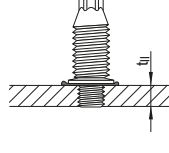

steel:
 $3 \text{ mm} \leq t_{II} < 6 \text{ mm}$,
aluminum:
 $5 \text{ mm} \leq t_{II} < 6 \text{ mm}$ drill
through hole

X-ST-GR,
X-CRM and
X-EM8H

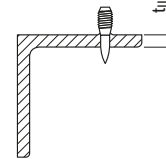

$t_{II} \geq 6 \text{ mm}$

*) for use in aluminum base material

Thickness of fastened material

Grating height: 25–50 mm with standard X-FCM. For other dimensions special X-FCM are available on demand.

Spacing and edge distance

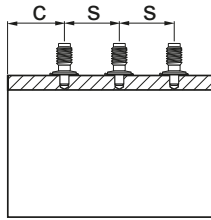
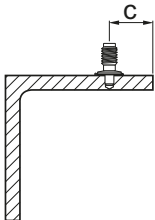

Fastener	Edge distance c	Spacing s
X-ST-GR, X-CRM, X-EM8H	$\geq 15 \text{ mm}$	$\geq 15 \text{ mm}$
X-BT, S-BT	$\geq 6 \text{ mm}$	$\geq 15 \text{ mm}$

Application limits

Fastener: X-CRM8, X-EM8H

Tool type: DX 460, DX 5, DX 6

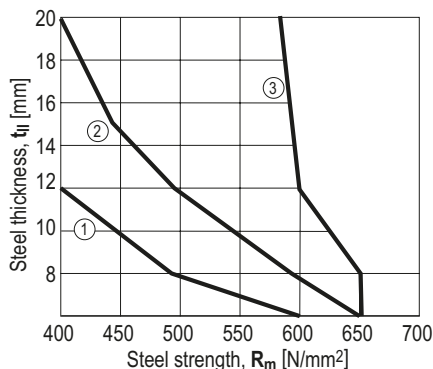

- ① X-CRM8-15-12 P8 / DX 460, DX 5, DX 6 (impact)
- ② X-CRM8-15-12 P8 / DX 460, DX 5 (co-acting)
- ③ X-EM8H-15-12 P8 / DX 460, DX 5, DX 6 (impact)

Tool type: DX 76, DX 76 PTR

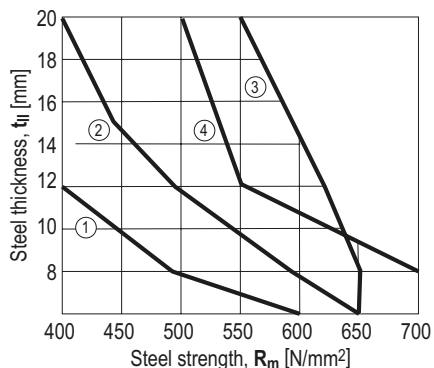

- ① X-CRM8-15-12 FP10 / DX 76, DX 76 PTR (impact)
- ② X-CRM8-15-12 FP10 / DX 76, DX 76 PTR (co-acting)
- ③ X-EM8H-15-12 FP10 / DX 76, DX 76 PTR (impact)
- ④ X-EM8H-15-12 P8 / DX 76, DX 76 PTR (impact)

Fastener: X-ST-GR

Tool type: DX 460, DX 5, DX 6

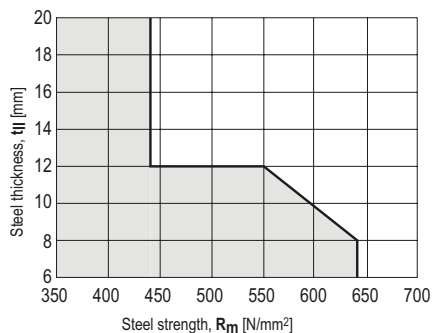

Tool type: DX 76 PTR

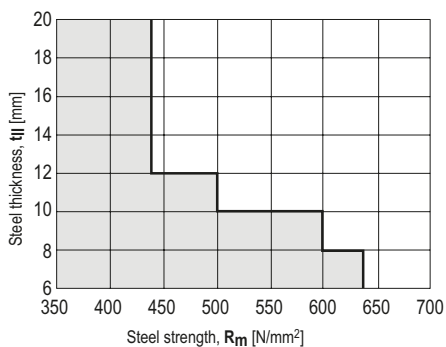

Fastener: X-BT

No application limits for use in high strength steel (f_u up to 1000 MPa)

No through penetration for base material thickness $t_{II} \geq 8$ mm [$\frac{5}{16}$ "]

Fastener: S-BT

The base material is limited to steel grade with a maximum tensile strength $f_u = 630$ MPa (91 ksi). The minimum tensile strength of steel is $f_u \geq 340$ MPa (49 ksi). The minimum tensile strength of aluminum is $f_u \geq 270$ MPa (39 ksi). Minimum thickness of base material t_{II} : refer to section "Thickness of base material" Maximum thickness of base material t_{II} : no limits

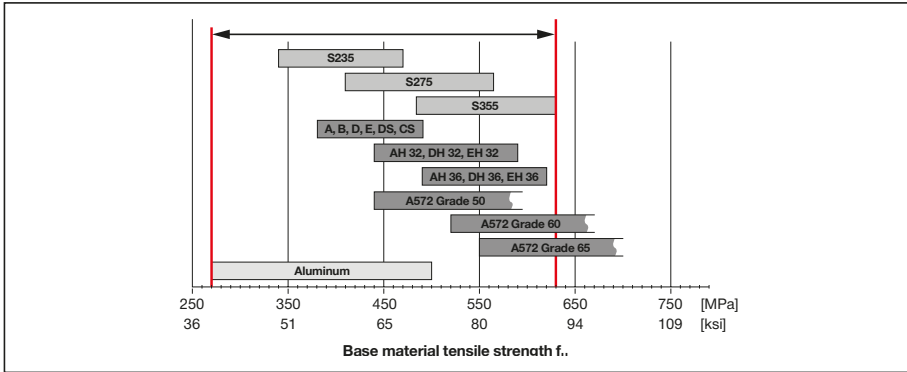

Corrosion information



- For more details, please refer to following technical document: Hilti Corrosion Handbook.

X-FCM

The X-FCM is Zn electroplated. The intended use of this coating is limited to corrosion category C1 according the standard EN ISO 9223 (indoors). The X-FCM carbon steel grating fasteners are to be used for fastening gratings made of coated or galvanized carbon steel or gratings made of reinforced fibreglass.



- The X-FCM fasteners intended use only comprises fastenings which are not directly exposed to external weather conditions or moist atmospheres.

X-FCM-M

The coating of the X-FCM-M carbon steel grating fasteners consists of an electroplated Zn-alloy for cathodic protection and a top coat for chemical resistance (duplex-coating). The intended use of this coating is limited to the corrosion category C1, C2 and C3 according the standard EN ISO 9223 (indoors, mildly corrosive environment). The X-FCM-M carbon steel grating fasteners are to be used for fastening gratings made of coated or galvanized carbon steel or gratings made of reinforced fibreglass.



- The X-FCM-M fasteners are not for use in marine atmospheres or in heavily polluted environments.

X-FCM-R

The X-FCM-R stainless steel grating fasteners are made from the stainless-steel type 1.4404, which is equivalent to AISI 316L (A4) steel grade. This grade of stainless steel is classified in the corrosion resistance class III according to DIN EN 1993-1-4:2015, which makes the material suitable for aggressive environments like in marine, offshore, petrochemical, caloric (coal, oil) power plants, etc. applications. The X-FCM-R stainless-steel grating fasteners are to be used for fastening gratings made of stainless steel or gratings made of reinforced fibreglass.



- The X-FCM-R fasteners are not for use in road tunnels, indoor swimming pools or similar environments without a project specific engineering judgement.

System recommendation



- For more details, please refer to the chapter **Accessories and consumables compatibility** in the Direct Fastening Technology Manual (DFTM).

Application area

X-FCM	X-FCM-M	X-FCM-R
Indoors, dry and non corrosive environment	Indoors, mildly corrosive environment, or for limited lifetime use	Marine, offshore, petrochemical, calorific (coal, oil) power plants, etc.

X-FCM grating element

X-FCM Zinc plated		X-FCM-M Duplex coated		X-FCM-R Stainless steel		Grating element length L	Grating height h
Item no.		Item no.		Item no.			
X-FCM 25/30	26582 or 2117353	X-FCM-M 25/30	378683 or 2117357	X-FCM-R 25/30	247181 or 2117391	23 mm	25–30 mm
X-FCM 1"-1 ¹ / ₄ "	247175 or 2117354	X-FCM-M 1"-1 ¹ / ₄ "	378686 or 2117358	X-FCM-R 1"-1 ¹ / ₄ "	247184 or 2117392	27 mm	29–34 mm
X-FCM 35/40	26583 or 2117355	X-FCM-M 35/40	378684 or 2117359	X-FCM-R 35/40	247182 or 2117393	33 mm	35–40 mm
X-FCM 45/50	26584 or 2117356	X-FCM-M 45/50	378685 or 2117390	X-FCM-R 45/50	247183 or 2117394	43 mm	45–50 mm
		X-FCM-M 31/36 L	2042852*			25 mm	31–36 mm
		*For use with X-BT M8-15-6 SN12-R S-BT-GR M8					
		Note: Not for use in marine atmosphere or in heavily polluted environment.		Note: Not for use in automobile tunnels, swimming pools or similar environments			

Tool recommendation for tightening grating element

Grating element	Tool
X-FCM X-FCM-M X-FCM-R	SF 100-A, SF 11-A, SF 150-A, SF 121-A, SF 14, SF 14-A, SF 18-A, SFC 18-A, SF 22-A, SFC 22-A, SBT 4-A22, Hilti Torque tool X-BT 1 ¹ / ₄ "

Threaded stud

Threaded stud		Item no.	Tool
X-EM8H-15-12 P8		271981	²⁾
X-EM8H-15-12 FP10		271982	²⁾
	X-BT M8-15-6 SN12-R	377074	³⁾
	X-CR M8-15-12 P8	372033	²⁾
	X-CR M8-15-12 FP10	372034	²⁾
	S-BT-GF M8/7 AN 6	2140527	^{4), 5)}
	S-BT-GR M8/7 SN 6	2140529	^{4), 5)}
	S-BT-GR M8/7 SN 6 AL	2140742	^{4), 5)}
	X-ST-GR M8/10 P8	2122460	²⁾

²⁾ DX 76 PTR, DX 460, DX 5, DX 6

⁴⁾ SF BT 18-A, SF BT 22-A and SBT 4-A22 for drilling the hole

³⁾ BX 3-BTG, DX 351-BTG

⁵⁾ SFC 18-A, SFC 22-A and SBT 4-A22 for screw-in the fastener

Cartridge selection and tool energy setting



- Fastener setting information (e.g. cartridge recommendation, tool power level adjustment, base material properties and fastend material properties) and installation information (e.g. quality assurance) are part of the corresponding product data sheet for fastener.

Material specification and coating

X-FCM grating element

	X-FCM-R		X-FCM-M+X-FCM-M_L		X-FCM		All systems Absorber ¹⁾
	^① Disk	^② Threaded stem	^① Disk	^② Threaded stem	^① Disk	^② Threaded stem	
Material designation	X2CrNiMo17122	X2CrNiMo17122	DC 04	11SMNPB30+C	DC 04	11SMNPB30+C	Polyurethane Black
Coating	none	none	Duplex *	Duplex *	≥ 20µm Zn	10-20 µm Zn	-

¹⁾ resistant to: UV, saltwater ozone, oil, grease

^{*}) comparable to 45 µm HDG steel (480 h Salt spray test per DIN 50021)

Threaded stud

	X-BT			X-ST-GR		X-EM8H
	Shank ^①	Threaded sleeve ^② SN12-R washer ^③	Sealing ring of sealing washer ¹⁾ ^④	Shank	Threaded sleeve	
Material designation	Stainless steel CR 500 (A4 / AISI316)	X2CrNiMo17132 X5CrNiMo17122+2H (A4 / AISI316)	Elastomer, black	P558 (CrMnMo alloy)	(A4 / AISI316)	Carbon steel Ck 67 MOD
Coating	none	none		none	none	5-13 µm Zn ²⁾

¹⁾ resistant to: UV, saltwater ozone, oil, grease

²⁾ Zinc applied by electroplating. Intended for corrosion protection during shipment, storage, construction and service in protected environment. It is not adequate for protection against corrosion in outside or otherwise corrosive applications

	S-BT_R			S-BT_F		
	Threaded Shank ^①	SN 12-R washer ^③	Sealing ring of sealing washer ¹⁾ ^③	Threaded Shank ^②	AN 10-F washer ^④	Sealing ring of sealing washer ¹⁾ ^②
Material designation	Stainless steel 1.4462 (A4 / AISI316)	Stainless steel 1.4404 (A4 / AISI316)	Elastomer, black	Carbon steel 1038	Aluminum	Elastomer, black
Coating	Zinc	none	none	Duplex-coating	none	HDG

¹⁾ resistant to: UV, salt water, ozone, oil, grease

²⁾ The surface of the S-BT stainless steel fasteners is zinc plated (anti-friction coating) in order to reduce the thread forming torque when the stud is screwed in into the base material.

Quality assurance

Fastener inspection

X-BT M8-15-6 SN12-R

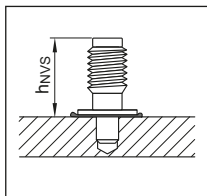

$h_{NVS} = 15.7 - 16.8 \text{ mm}$

X-BT-GR M8/7 SN8

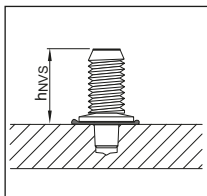

$h_{NVS} = 15.7 - 16.8 \text{ mm}$

X-CRM8-15-12

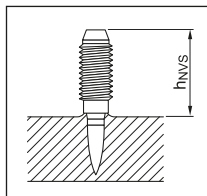

$h_{NVS} = 17 - 20 \text{ mm}$

X-EM8H-15-12

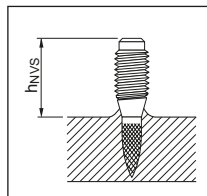

$h_{NVS} = 15.5 - 19.5 \text{ mm}$

X-ST-GR M8/10 P8

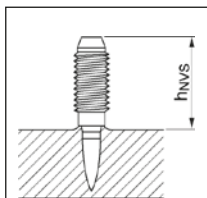

$h_{NVS} = 17.0 - 20.0 \text{ mm}$

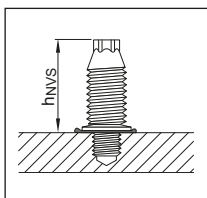

S-BT-___/7___6

$h_{NVS} = 18.6 - 19.1 \text{ mm [0.732" - 0.752"]}$

Installation recommendation

Tightening torque for fastening to steel base material $t_{II} \geq 6$ mm

	Fastener: X-ST-GR, X-CR, X-BT-GR, S-BT-GR, S-BT-GF, X-EM8H
Element: X-FCM, X-FCM-M, X-FCM-R, X-FCM-M_L	5–8 Nm

Tightening tool recommendation for tightening with cordless screwdriver

Cordless screwdriver	Clutch type (stop detection)	Gear	Clutch
SF 2-A12	TRC	1	15
SF 2H-A12	TRC	1	15
SF 4-A22	TRC	1	8
SF 6-A22	ESC (SJ)	1	7
SF 6H-A22	ESC (SJ)	1	7
SF 18-A	TRC	1	5
SFC 18-A	TRC	1	5
SF 22-A	TRC	1	5
SFC 22-A	TRC	1	5
SBT 4-A22	TRC	1	7



• Tool power level adjustment:

Gear:



Clutch:



- The setting of the torque via the Hilti screwdriver with torque release coupling (TRC) can change as the clutch wears over time. The specified torque setting is only a rough guide value and applies to a new Hilti screwdriver. To ensure recommended torque is applied, Hilti recommends the use of a calibrated torque wrench or the Hilti torque tool.
- The specified torque setting for the Hilti screw drivers with electronic slip clutch (ESC) is only a rough guide value as the ESC has 2 stop detections; Soft Joint (SJ) detection and Hard Joint (HJ) detection. The hard joint detection is activated due to drop in speed (fast stop) and can lead to a torque spike. The installation torque may vary depending on the user and the application. To ensure recommended torque is applied, Hilti recommends the use of a calibrated torque wrench or the Hilti torque tool.

Tightening tool recommendation for tightening with Hilti torque tool

Hilti torque tool

Torque tool S-BT 1/4" – 5 Nm

Torque tool X-BT 1/4" – 8 Nm

Tightening torque for fastening to aluminum base material

	Fastener: S-BT-GR, S-BT-GF, S-BT-GR AL
Element: X-FCM, X-FCM-M, X-FCM-R, X-FCM-M_L	5 Nm

Tightening tool recommendation for tightening with cordless screwdriver

Cordless screwdriver	Clutch type (stop detection)	Gear	Clutch
SF 2-A12	TRC	1	15
SF 2H-A12	TRC	1	15
SF 4-A22	TRC	1	4
SF 6-A22	ESC (SJ)	1	5
SF 6H-A22	ESC (SJ)	1	5
SF 18-A	TRC	1	4
SFC 18-A	TRC	1	4
SF 22-A	TRC	1	4
SFC 22-A	TRC	1	4
SBT 4-A22	TRC	1	5



- Tool power level adjustment:

Gear:



Clutch:



- The setting of the torque via the Hilti screwdriver with torque release coupling (TRC) can change as the clutch wears over time. The specified torque setting is only a rough guide value and applies to a new Hilti screwdriver. Hilti recommends using a calibrated torque wrench or the Hilti Torque tool to apply the recommended torque.
- The specified torque setting for the Hilti screw drivers with electronic slip clutch (ESC) is only a rough guide value as the ESC has 2 stop detections; Soft Joint (SJ) detection and Hard Joint (HJ) detection. The hard joint detection is activated due to drop in speed (fast stop) and can lead to a torque spike. The installation torque may vary depending on the user and the application. Hilti recommends using a calibrated torque wrench or the Hilti Torque tool to apply the recommended torque.

Tightening tool recommendation for tightening with Hilti torque tool

Hilti torque tool

Torque tool S-BT 1/4" – 5 Nm

X-FCM-R HL Grating fastening system

Product data

Dimensions

X-FCM-R HL

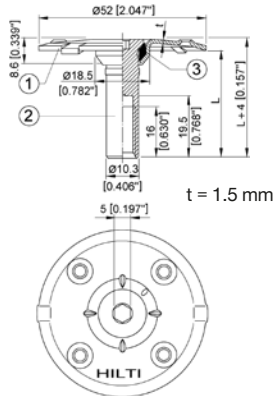

X-BT-GR M8/7 SN 8

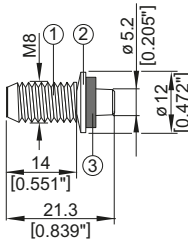

X-SEA-R30 M8

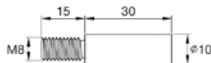

Features and benefits

The X-FCM-R HL together with the X-BT-GR M8 threaded fasteners forms a high resistance and robust fastening system to fix grating in marine C5 corrosive environment:

- High tension resistance for use in wave zones
- Robust shear behavior
- No rework of backside of coated base material with thickness ≥ 8 mm
- Base material coating up to 500 μm
- No application limits in terms of base material strength and thickness
- Vibration resistant

Material specifications

Disk (1) and	A4 / 316
threaded stem (2):	1.4404, X2CrNiMo17-12-2
Absorber (3) ¹⁾ :	TPU – thermoplastic polyurethane, red

¹⁾ resistant to: UV, saltwater, ozone, oil, grease

X-SEA-R 30 M8:	A4 / 316 1.4401 or 1.4571
----------------	------------------------------

Recommended fastening tools

- For more details, please refer to **X-FCM-R HL fastener program** and to the chapter **Accessories and consumables compatibility** in the Direct Fastening Technology Manual (DFTM).

Approvals and certificate

ABS, BV, DNV GL, LR

- Not all information presented in this product data sheet might be subject to approval/certificate content. Please refer to approval/certificate for further information.

Application

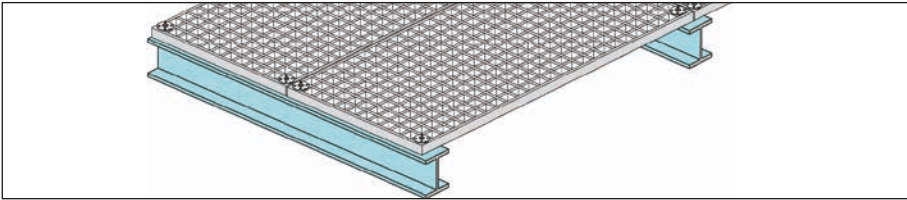

Position and fix steel or fibre-reinforced grating to steel

Performance data

Recommended tensile loads

Grating opening type

Rectangular

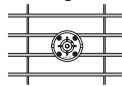

Clear bar spacing [mm] ¹⁾

18 to 24 >24 to 30 >30 to 35 >35 to 44

X-FCM-R HL	2.8	2.1	1.4	0.7
------------	-----	-----	-----	-----

Grating opening type

Square

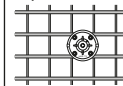

Clear mesh width [mm]

18 to 38²⁾ > 38 to 44¹⁾

X-FCM-R HL	3.6	1.2
------------	-----	-----

¹⁾ Loading is limited by elastic limit of the X-FCM-R HL grating fastener.

²⁾ Loading is limited by recommended load of threaded stud X-BT-GR M8/7 SN 8. Exceeding recommended loads might reduce the pre-tensioning of the connection.

Remark: Full utilization of X-FCM-R HL load data requires the use of the X-BT-GR M8/7 SN 8 threaded stud with $T = 16 - 20 \text{ Nm}$

Characteristic tensile loads N_{Rk} can be conservatively calculated by multiplying the recommended load values N_{rec} with the factor 2.8, $N_{Rk} = 2.8 * N_{rec}$

Recommended shear loads

Without extension adapter X-SEA-R

For grating with clear rectangular mesh width from 18 to 44 mm:

$$V_{rec} = 0.4 \text{ kN}$$

For grating with clear square mesh width from 18 to 44 mm:

$$V_{rec} = 0.6 \text{ kN}$$

With extension adapter X-SEA-R

For grating with clear rectangular or square mesh width from 18 to 44 mm:

$$V_{rec} = 0.4 \text{ kN}$$

Notes

Those recommended loads V_{rec} are based on friction under standard conditions without the presence of lubricants (e.g. oil, grease) and require the application of an installation torque $T = 16 - 20 \text{ Nm}$. The respective slips are in the range of 0.2 mm.

Those values allow robust positioning e.g. in case of transportation of preassembled units. Structural applications – e.g. stabilizing the compression flange of a supporting beam, if the grating is used as a diaphragm – are out of scope of the X-FCM-R HL grating fastener.

Load displacement behavior – examples:

Tensile load

Example with square grating and a clear mesh width of 30 x 30 mm

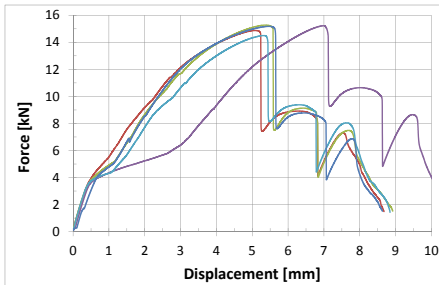

Failure mode: Pull-over of disk (1) over the threaded stem (2)

Shear load

Example with rectangular grating and a clear bar spacing of 44 mm

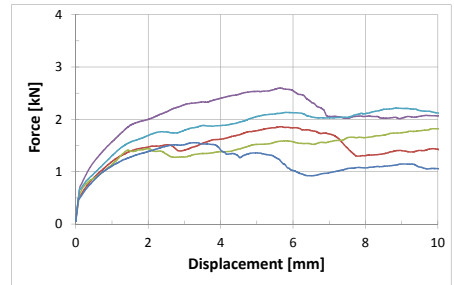

Notes:

Graph shows slipping behavior due to friction. The actual ultimate resistance will be significantly higher, as the grating itself will get into contact with the X-FCM-R HL fastener. However, those resistances are not used for design purpose due to the high deformation at those states.

Application recommendation

Thickness of base material

X-BT-GR M8/7 SN8

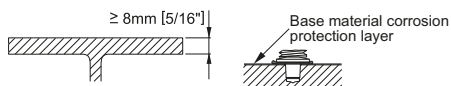

To prevent damage of back side coating: base material thickness ≥ 8 mm.

Thickness of base material corrosion protection considered up to 500 μm .

Thickness of fastened material

Grating height: 28–43 mm, 48–53 mm

Grating height: 58–73 mm, 78–83 mm with the extension adapter X-SEA-R30 M8.

Spacing and edge distance

 Edge distance: $c \geq 10 \text{ mm}$

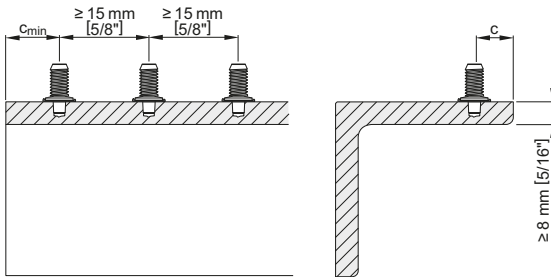
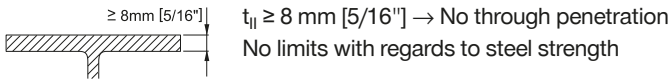
 Spacing: $\geq 15 \text{ mm}$

Application limit

Corrosion information

X-FCM-R HL and X-BT-GR grating fastening system is intended for use in coastal and offshore applications

Fastener program and system recommendation

Fastener program

X-FCM-R HL

Designation	Item no.	Dimensions	
		L [mm]	Grating height H _G [mm]
X-FCM-R HL 25/30	2194345	23	28 – 33
X-FCM-R HL 1" - 1¼"	2194346	27	32 – 37
X-FCM-R HL 35/40	2194347	33	38 – 43
X-FCM-R HL 45/50	2194348	43	48 – 53

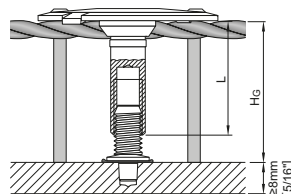

X-FCM-R HL in combination with X-SEA-R30 M8 (Item no. 432274)

Designation	Item no.	Dimensions	
		L [mm]	Grating height H _G [mm]
X-FCM-R HL 25/30	2194345	53	58 – 63
X-FCM-R HL 1" - 1¼"	2194346	57	62 – 67
X-FCM-R HL 35/40	2194347	63	68 – 73
X-FCM-R HL 45/50	2194348	73	78 – 83

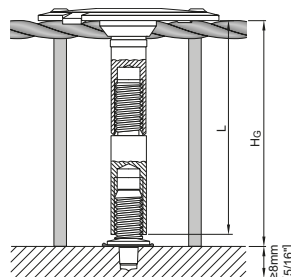

X-BT-GR stainless steel stud

Designation	Item no.	Tool Designation
X-BT-GR M8/7 SN 8	2194344	DX 351-BTG

Cartridge selection and tool energy setting

6.8/11 M10 high precision brown cartridge

- Tool power level adjustment by setting tests on site.
- Start tool energy selection with lowest recommended tool power level.
- Correct according requirement from chapter quality assurance.

Quality assurance

Fastening inspection

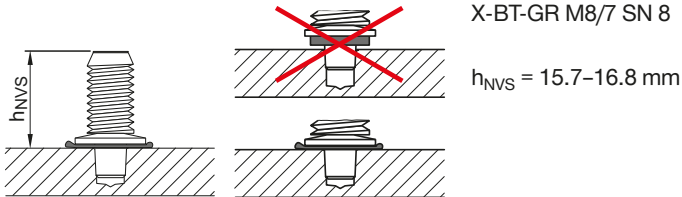

Installation recommendation

Tightening torque

	Fastener: X-BT-GR
Element: X-FCM-R HL	16-20 Nm

Tightening tool recommendation for tightening with cordless screwdriver

Cordless screwdriver	Clutch type (stop detection)	Gear	Clutch
SF 6-A22	ESC (SJ)	1	15
SF 6H-A22	ESC (SJ)	1	15



- Tool power level adjustment:

Gear:



Clutch:



- The specified torque setting for the Hilti screw drivers with electronic slip clutch (ESC) is only a rough guide value as the ESC has 2 stop detections; Soft Joint (SJ) detection and Hard Joint (HJ) detection. The hard joint detection is activated due to drop in speed (fast stop) and can lead to a torque spike. The installation torque may vary depending on the user and the application. To ensure recommended torque is applied, Hilti recommends the use of a calibrated torque wrench or the Hilti torque tool.

Tightening tool recommendation for tightening with Hilti torque tool

Hilti torque tool

Torque tool X-BT 1/4" - 20 Nm

X-FCM NG Grating fastening system

Product data

Designation

Example	Technology	Product identifier	Material	Grating type	Minimum grating height	Maximum grating height
X-FCM-R NG 28/33	X	FCM	R	NG	28	33
X-FCM-M NG 28/33	X	FCM	M	NG	28	33

Product description

X-FCM-R NG



X-FCM-M NG



- Labour-saving grating installation – fewer steps than traditional grating clamps and welding.
- No surface rework needed – when fastening grating to steel ≥ 6 mm thick.
- Durable hold – locking tabs on the disc help to prevent loosening or spinning.
- Reduce trip hazards – these fasteners have a non-slip surface and protrude less than 4 mm from walkway grating when correctly installed.

Grating fastening system

Grating element	Fastener	
	S-BT-GR NG M8/7 SN 6	S-BT-GF NG M8/7 AN 6
X-FCM-R NG	■	N/A
X-FCM-M NG	□	■

■ = recommended for combination

□ = suitable for combination

N/A = not applicable

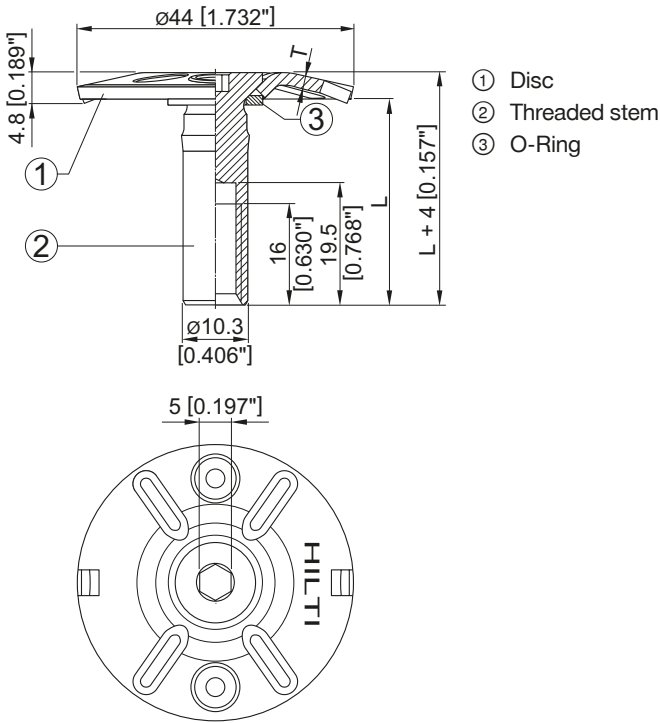
Technical drawing for grating element X-FCM-R NG, X-FCM-M NG

Dimensions for grating elements

Designation	Disc diameter	Threaded stem length L
X-FCM-R NG 28/33	44 mm	23 mm
X-FCM-R NG 32/37	44 mm	27 mm
X-FCM-R NG 38/43	44 mm	33 mm
X-FCM-R NG 48/53	44 mm	43 mm
X-FCM-M NG 28/33	44 mm	23 mm
X-FCM-M NG 32/37	44 mm	27 mm
X-FCM-M NG 38/43	44 mm	33 mm
X-FCM-M NG 48/53	44 mm	43 mm

Material specification and material properties for stainless steel parts

Designation	Element	Material	Coating	Steel grade acc. to EN 10088	Corrosion resistance acc. to EN 1993-1-4
X-FCM-R NG	Disc	Stainless steel	–	1.4404	CRC III
X-FCM-R NG	Threaded stem	Stainless steel	–	1.4404	CRC III

Material specification and material properties for carbon steel parts

Designation	Element	Material	Coating	Corrosion category acc. to EN ISO 9223
X-FCM-M NG	Disc	Carbon steel	Duplex coated	C1, C2, C3
X-FCM-M NG	Threaded stem	Carbon steel	Duplex coated	C1, C2, C3

Material specification and material properties for plastic parts

Designation	Element	Material	Color	Other properties
X-FCM-R NG	O-Ring	Polyurethan (PUR)	Black	
X-FCM-M NG	O-Ring	Polyurethan (PUR)	Black	

Approvals/certificates

Authority	Approval/certificate no.	Date of issue	Short description
American Bureau of Shipping ABS	18-1785836-1-PDA	05/2021	Marine and Offshore Industry
Bureau Veritas BV	45116/BO	03/2021	Marine and Offshore Industry
Det Norske Veritas DNV	TAS00001UJ	04/2021	Marine and Offshore Industry

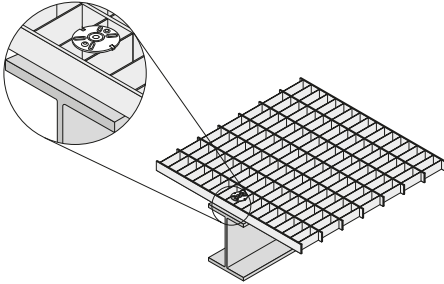
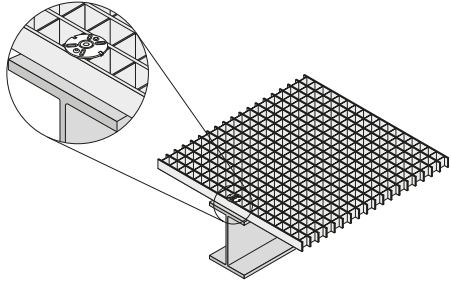
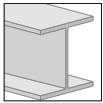

- Information presented in this product data sheet is based on Hilti Technical Data.
- For the specific application please refer to the corresponding approval/certificate.

Application**Securing rectangular grating****Securing square grating****Base material**

Steel

Load condition

Static/quasi static

Environmental conditions

Environmental condition		X-FCM-R NG combined with S-BT-GR NG M8/7 SN 6	X-FCM-M NG combined with S-BT-GR NG M8/7 SN 6	X-FCM-M NG combined with S-BT-GF NG M8/7 AN 6
	Dry indoor	■	■	■
	Indoor with temporary condensation	■	■	■
	Outdoor with low pollution	■	□	□
	Outdoor with moderate concentration of pollutants	■	□	□
	Coastal areas	■	N/A	N/A
	Outdoor, areas with heavy industrial pollution	■	N/A	N/A
	Close proximity to roads	■	N/A	N/A
	Special application	N/A	N/A	N/A
	Special application	N/A	N/A	N/A

■ = suitable for combination

□ = suitable for combination, requires expert evaluation

N/A = not applicable



- Grating fastening system not to be used in wave zones due to high load impact.
- For applications in wave zones please contact Hilti.

Fastener program

Item no. and description

Designation	Item no.	Description
X-FCM-R NG 28/33	2279757	Stainless steel grating element
X-FCM-R NG 32/37	2279758	
X-FCM-R NG 38/43	2279759	
X-FCM-R NG 48/53	2279752	
X-FCM-M NG 28/33	2279753	Carbon steel grating element
X-FCM-M NG 32/37	2279754	
X-FCM-M NG 38/43	2279755	
X-FCM-M NG 48/53	2279756	
S-BT-GR NG M8/7 SN 6	2302142	Threaded stud for highly corrosive environment
S-BT-GF NG M8/7 AN 6	2302143	Threaded stud for mildly corrosive environment
TS-BT 5.5-110 S	2201685	Stepped drill bit for use in combination with the S-CS NG centering spacer
S-CS NG	2310191	Centering Spacer for perpendicular pilot hole drilling and precise location of studs
S-DG BT M8/7 Short 6	2279735	Depth gauge for exact setting of the S-BT
S-BT ¼" – 5 Nm	2143271	Manual torque tool (5 Nm)
X-BT ¼" – 8 Nm	2119272	Manual torque tool (8 Nm)
5 mm Allen-type bit		

Application recommendation for securing grating to steel

Grating material and grating material properties for square grating

	Grating type	Square grating
	Grating material	Carbon steel bar grating, stainless steel bar grating, reinforced fibreglass grating
	Bearing bar thickness	to be qualified by grating manufacturer
	$t_{\text{bearing bar}}$	
	Clear bar spacing	18 to 22 mm
	$W_{\text{bearing bar}}$	
	Clear cross bar spacing	18 to 22 mm
	$W_{\text{cross bar}}$	
Bearing bar height	28 to 53 mm	
$h_{\text{bearing bar}}$		

Grating material and grating material properties for rectangular grating

Grating type	Rectangular grating
Grating material	Carbon steel bar grating, stainless steel bar grating, reinforced fibreglass grating
Bearing bar thickness $t_{\text{bearing bar}}$	to be qualified by grating manufacturer
Clear bar spacing $W_{\text{bearing bar}}$	13 to 22 mm
Clear cross bar spacing $W_{\text{cross bar}}$	≥ 18 mm
Bearing bar height $h_{\text{bearing bar}}$	28 to 53 mm

Base material properties and fastener positioning in base material

Base material	Steel
Steel grade according to EN 10025-2	S235 to S355
Steel grade according to EN 10025-3	S420
Steel grade according to EN 10346	S280GD to S420GD
Base material tensile strength R_m	360 to 630 MPa
Base material thickness $t_{ }$	≥ 3 mm



- Fastener positioning in base material is describe in the corresponding Product Data Sheet (PDS) for S-BT-GR NG and S-BT-GF NG.
- For base material thickness $3 \text{ mm} \leq t_{||} \leq 6 \text{ mm}$ rework of the coating on the back side of the plate/profile may be needed.

Grating element recommendation

Designation	Grating material	Grating type	Minimum bearing bar height	Maximum bearing bar height
			$h_{\text{bearing bar, min}}$	$h_{\text{bearing bar, max}}$
X-FCM-R NG 28/33	Carbon steel, stainless steel and reinforced fibreglass	Square and rectangular grating	28 mm	33 mm
X-FCM-R NG 32/37			32 mm	37 mm
X-FCM-R NG 38/43			38 mm	43 mm
X-FCM-R NG 48/53			48 mm	53 mm
X-FCM-M NG 28/33	Carbon steel and reinforced fibreglass	Square and rectangular grating	28 mm	33 mm
X-FCM-M NG 32/37			32 mm	37 mm
X-FCM-M NG 38/43			38 mm	43 mm
X-FCM-M NG 48/53			48 mm	53 mm



- Please contact Hilti for grating element recommendation when the requirements deviate from the standard.

Performance data

Recommended resistance under tension load for grating fastening system

Designation	Grating type	Clear bar spacing $w_{\text{bearing bar}}$	Base material steel grade	Base material thickness $t_{ }$	Tension load N_{rec}
X-FCM-R NG combined with S-BT-GR NG M8/7 SN 6	Square grating	18 mm	S235 to S275,	$3 \leq t_{ } \leq 5 \text{ mm}$	1.8 kN
		22 mm			
		18 mm	S280GD to S350GD	$t_{ } \geq 5 \text{ mm}$	1.9 kN
		22 mm			
		18 mm	S355, S420, S390GD to S420GD	$3 \leq t_{ } \leq 5 \text{ mm}$	2.1 kN
		22 mm			
18 mm	$t_{ } \geq 5 \text{ mm}$	2.3 kN			
22 mm					
X-FCM-M NG combined with S-BT-GR NG M8/7 SN 6	Square grating	18 mm	S235 to S275,	$3 \leq t_{ } \leq 5 \text{ mm}$	1.8 kN
		22 mm			1.7 kN
		18 mm	S280GD to S350GD	$t_{ } \geq 5 \text{ mm}$	1.9 kN
		22 mm			1.7 kN
		18 mm	S355, S420, S390GD to S420GD	$3 \leq t_{ } \leq 5 \text{ mm}$	2.1 kN
		22 mm			1.7 kN
18 mm	$t_{ } \geq 5 \text{ mm}$	2.3 kN			
22 mm		1.7 kN			
X-FCM-M NG combined with S-BT-GF NG M8/7 AN 6	Square grating	18 mm	S235 to S275,	$3 \leq t_{ } \leq 5 \text{ mm}$	1.9 kN
		22 mm			1.7 kN
		18 mm	S280GD to S350GD	$t_{ } \geq 5 \text{ mm}$	2.0 kN
		22 mm			1.7 kN
		18 mm	S355, S420, S390GD to S420GD	$3 \leq t_{ } \leq 5 \text{ mm}$	2.3 kN
		22 mm			1.7 kN
18 mm	$t_{ } \geq 5 \text{ mm}$	2.4 kN			
22 mm		1.7 kN			

Recommended resistance under tension load for grating fastening system

Designation	Grating type	Clear bar spacing $w_{\text{bearing bar}}$	Base material steel grade	Base material thickness t_{II}	Tension load N_{rec}
X-FCM-R NG combined with S-BT-GR NG M8/7 SN 6	Rectangular grating	13 mm	S235 to S275, S280GD to S350GD	$3 \leq t_{II} \leq 5 \text{ mm}$	1.8 kN
		18 mm			
		22 mm			
		13 mm		$t_{II} \geq 5 \text{ mm}$	1.9 kN
		18 mm			
		22 mm			
		13 mm	S355, S420, S390GD to S420GD	$3 \leq t_{II} \leq 5 \text{ mm}$	2.1 kN
		18 mm			
		22 mm			
		13 mm		$t_{II} \geq 5 \text{ mm}$	2.3 kN
		18 mm			2.3 kN
		22 mm			2.1 kN
X-FCM-M NG combined with S-BT-GR NG M8/7 SN 6	Rectangular grating	13 mm	S235 to S275, S280GD to S350GD	$3 \leq t_{II} \leq 5 \text{ mm}$	1.8 kN
		18 mm			1.8 kN
		22 mm			1.2 kN
		13 mm		$t_{II} \geq 5 \text{ mm}$	1.9 kN
		18 mm			1.9 kN
		22 mm			1.2 kN
		13 mm	S355, S420, S390GD to S420GD	$3 \leq t_{II} \leq 5 \text{ mm}$	2.1 kN
		18 mm			2.1 kN
		22 mm			1.2 kN
		13 mm		$t_{II} \geq 5 \text{ mm}$	2.3 kN
		18 mm			2.1 kN
		22 mm			1.2 kN
X-FCM-M NG combined with S-BT-GF NG M8/7 AN 6	Rectangular grating	13 mm	S235 to S275, S280GD to S350GD	$3 \leq t_{II} \leq 5 \text{ mm}$	1.9 kN
		18 mm			1.9 kN
		22 mm			1.2 kN
		13 mm		$t_{II} \geq 5 \text{ mm}$	2.0 kN
		18 mm			2.0 kN
		22 mm			1.2 kN
		13 mm	S355, S420, S390GD to S420GD	$3 \leq t_{II} \leq 5 \text{ mm}$	2.3 kN
		18 mm			2.1 kN
		22 mm			1.2 kN
		13 mm		$t_{II} \geq 5 \text{ mm}$	2.4 kN
		18 mm			2.1 kN
		22 mm			1.2 kN

Design resistance under tension load for grating fastening system

Designation	Grating type	Clear bar spacing $w_{\text{bearing bar}}$	Base material steel grade	Base material thickness $t_{ }$	Tension load N_{Rd}
X-FCM-R NG combined with S-BT-GR NG M8/7 SN 6	Square grating	18 mm	S235 to S275,	$3 \leq t_{ } \leq 5 \text{ mm}$	2.5 kN
		22 mm			
		18 mm	S280GD to S350GD	$t_{ } \geq 5 \text{ mm}$	2.7 kN
		22 mm			
		18 mm	S355, S420, S390GD to S420GD	$3 \leq t_{ } \leq 5 \text{ mm}$	3.0 kN
		22 mm			
18 mm	$t_{ } \geq 5 \text{ mm}$	3.2 kN			
22 mm					
X-FCM-M NG combined with S-BT-GR NG M8/7 SN 6	Square grating	18 mm	S235 to S275,	$3 \leq t_{ } \leq 5 \text{ mm}$	2.5 kN
		22 mm			2.4 kN
		18 mm	S280GD to S350GD	$t_{ } \geq 5 \text{ mm}$	2.7 kN
		22 mm			2.4 kN
		18 mm	S355, S420, S390GD to S420GD	$3 \leq t_{ } \leq 5 \text{ mm}$	3.0 kN
		22 mm			2.4 kN
18 mm	$t_{ } \geq 5 \text{ mm}$	3.2 kN			
22 mm		2.4 kN			
X-FCM-M NG combined with S-BT-GF NG M8/7 AN 6	Square grating	18 mm	S235 to S275,	$3 \leq t_{ } \leq 5 \text{ mm}$	2.7 kN
		22 mm			2.4 kN
		18 mm	S280GD to S350GD	$t_{ } \geq 5 \text{ mm}$	2.8 kN
		22 mm			2.4 kN
		18 mm	S355, S420, S390GD to S420GD	$3 \leq t_{ } \leq 5 \text{ mm}$	3.2 kN
		22 mm			2.4 kN
18 mm	$t_{ } \geq 5 \text{ mm}$	3.3 kN			
22 mm		2.4 kN			

Design resistance under tension load for grating fastening system

Designation	Grating type	Clear bar spacing $w_{\text{bearing bar}}$	Base material steel grade	Base material thickness t_{II}	Tension load N_{Rd}
X-FCM-R NG combined with S-BT-GR NG M8/7 SN 6	Rectangular grating	13 mm	S235 to S275,	$3 \leq t_{II} \leq 5 \text{ mm}$	2.5 kN
		18 mm			
		22 mm			
		13 mm	S280GD to S350GD	$t_{II} \geq 5 \text{ mm}$	2.7 kN
		18 mm			
		22 mm			
		13 mm	S355, S420, S390GD to S420GD	$3 \leq t_{II} \leq 5 \text{ mm}$	3.0 kN
		18 mm			
		22 mm			
		13 mm		$t_{II} \geq 5 \text{ mm}$	3.2 kN
		18 mm			3.2 kN
		22 mm			2.9 kN
		X-FCM-M NG combined with S-BT-GR NG M8/7 SN 6	Rectangular grating	13 mm	S235 to S275,
18 mm	2.5 kN				
22 mm	1.7 kN				
13 mm	S280GD to S350GD			$t_{II} \geq 5 \text{ mm}$	2.7 kN
18 mm					2.7 kN
22 mm					1.7 kN
13 mm	S355, S420, S390GD to S420GD			$3 \leq t_{II} \leq 5 \text{ mm}$	3.0 kN
18 mm					3.0 kN
22 mm					1.7 kN
13 mm				$t_{II} \geq 5 \text{ mm}$	3.2 kN
18 mm					2.9 kN
22 mm					1.7 kN
X-FCM-M NG combined with S-BT-GF NG M8/7 AN 6	Rectangular grating			13 mm	S235 to S275,
		18 mm	2.7 kN		
		22 mm	1.7 kN		
		13 mm	S280GD to S350GD	$t_{II} \geq 5 \text{ mm}$	2.8 kN
		18 mm			2.8 kN
		22 mm			1.7 kN
		13 mm	S355, S420, S390GD to S420GD	$3 \leq t_{II} \leq 5 \text{ mm}$	3.2 kN
		18 mm			2.9 kN
		22 mm			1.7 kN
		13 mm		$t_{II} \geq 5 \text{ mm}$	3.3 kN
		18 mm			2.9 kN
		22 mm			1.7 kN



- Redundancy of fastening points is required.
- Base metal vibration and stress effects (e.g. tensile stress effects) are considered.
- For base material thickness $3 \text{ mm} \leq t_{II} \leq 6 \text{ mm}$ rework of coating on the backside of the plate/profile may be needed.
- Grating fastening system resists shear load by friction.
- Grating fastening system is not suitable for shear load design, e.g. diaphragm.
- Depending on surface characteristics, shear load up to 0.3 kN will not result in permanent deformation.
- Generally, small unexpected shear loads can be accommodated without damage.

Installation recommendation

X-FCM-R NG

Tightening torque

Designation	Tightening torque
X-FCM-R NG combined with S-BT-GR NG M8/7 SN 6	8 Nm

Tightening tool recommendation for fastening with battery-actuated tool

Cordless screwdriver	Clutch type (stop detection)	Gear	Clutch
SF 4-A22	TRC	1	8
SF 6-A22	ESC (HJ)	1	7
SF 6H-A22	ESC (HJ)	1	7
SBT 4-A22	TRC	1	7

Tightening tool recommendation for fastening with torque tool

Hilti torque tool

Torque tool X-BT 1/4" – 8 Nm

X-FCM-M NG
Tightening torque

Designation	Tightening torque
X-FCM-M NG combined with S-BT-GR NG M8/7 SN 6	5 Nm
X-FCM-M NG combined with S-BT-GF NG M8/7 AN 6	5 Nm

Tightening tool recommendation for fastening with battery-actuated tool

Cordless screwdriver	Clutch type (stop detection)	Gear	Clutch
SF 2-A12	TRC	1	15
SF 2H-A12	TRC	1	15
SF 4-A22	TRC	1	4
SF 6-A22	ESC (HJ)	1	5
SF 6H-A22	ESC (HJ)	1	5
SBT 4-A22	TRC	1	5

Tightening tool recommendation for fastening with torque tool
Hilti torque tool

Torque tool S-BT 1/4" – 5 Nm



- Tool power level adjustment:



Clutch:



- The setting of the torque via the Hilti screwdriver with torque release coupling (TRC) can change as the clutch wears over time. The specified torque setting is only a rough guide value and applies to a new Hilti screwdriver. Hilti recommends using a calibrated torque wrench or the Hilti Torque tool to apply the recommended torque.
- The specified torque setting for the Hilti screw drivers with electronic slip clutch (ESC) is only a rough guide value as the ESC has 2 stop detections; Soft Joint (SJ) detection and Hard Joint (HJ) detection. The hard joint detection is activated due to drop in speed (fast stop) and can lead to a torque spike. The installation torque may vary depending on the user and the application. Hilti recommends using a calibrated torque wrench or the Hilti Torque tool to apply the recommended torque.

X-FCI-M Grating fastening system

Product data

Dimensions

X-FCI-M and X-FCI-M L X-FCI-M C

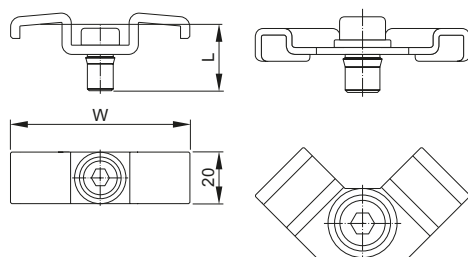

Dimension

See main section Fastener selection and system recommendation for dimension W and L.

Material specifications

See section Material specifications and coatings in the next pages for more details.

Recommended fastening tools

- For more details, please refer to Fastener selection.

X-ST-GR M8/10 P8

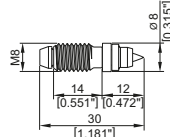

X-BT M8-15-6 SN12-R

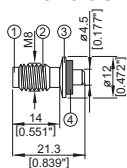

X-BT-GR M8/7 SN 8

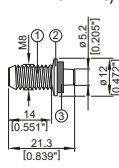

S-BT-GF M8/7 AN 6
S-BT-GR M8/7 SN 6
S-BT-GR M8/7 SN 6 AL

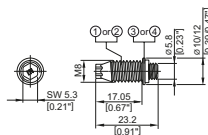

Application

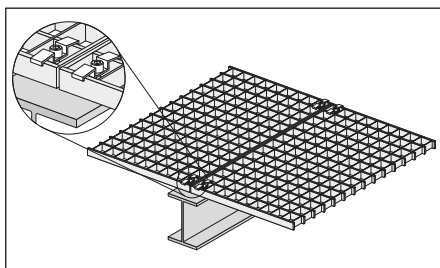

For fastenings exposed to weather and mildly corrosive conditions.

Not for use in marine atmospheres (upstream)!

Performance data

Recommended resistance under tension load

$$N_{rec} = 0.8 \text{ kN (180 lb)}$$

- Tensile loading is limited by plastic deformation of the saddle clip
- X-FCI-M resists shear by friction and is not suitable for explicit shear load design

Application recommendation

Base material thickness

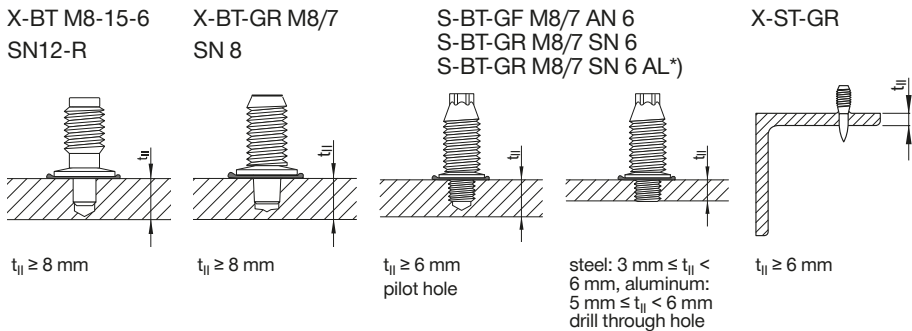

*) for use in aluminum base material

Fastened material thickness

Grating height: X-FCI-M:
 $HG = 28-52 \text{ mm (1.10"-2.05")}$, other dimensions for X-FCI-M are available on demand.
 See **Fastener selection** for detailed dimensions

Fastener positioning in base material

<p><u>X-ST-GR</u></p> <p>Edge distances: $c \geq 15 \text{ mm}$</p> <p>Spacing: $s \geq 15 \text{ mm}$</p>	<p><u>X-BT, X-BT-GR, S-BT</u></p> <p>Edge distance: $c \geq 6 \text{ mm}$</p> <p>Spacing: $s \geq 15 \text{ mm}$</p>
--	--

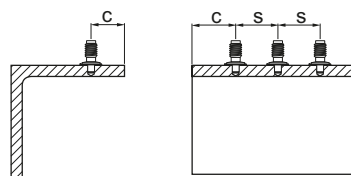

Application limits

Fastener: X-ST-GR

Tool type: DX 460, DX 5, DX 6

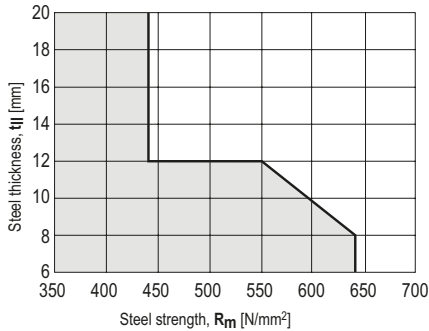

Tool type: DX 76 PTR

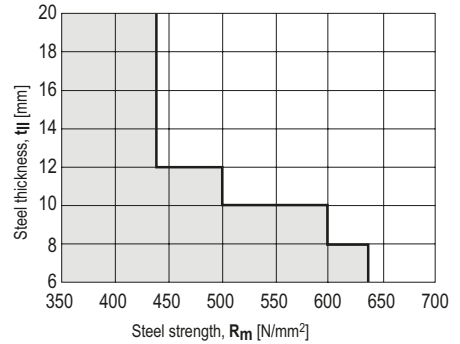

Fastener: X-BT and X-BT-GR

No application limits

→ using in high strength steel (f_u up to 1000 MPa)

No through penetration

→ $t_{II} \geq 8 \text{ mm}$ [$5/16''$]

Fastener: S-BT

The base material is limited to steel grade with a maximum tensile strength $f_u = 630 \text{ MPa}$ (91 ksi). The minimum tensile strength of steel is $f_u \geq 340 \text{ MPa}$ (49 ksi). The minimum tensile strength of aluminum is $f_u \geq 270 \text{ MPa}$ (39 ksi). Minimum thickness of base material t_{II} : refer to section “Thickness of base material” Maximum thickness of base material t_{II} : no limits

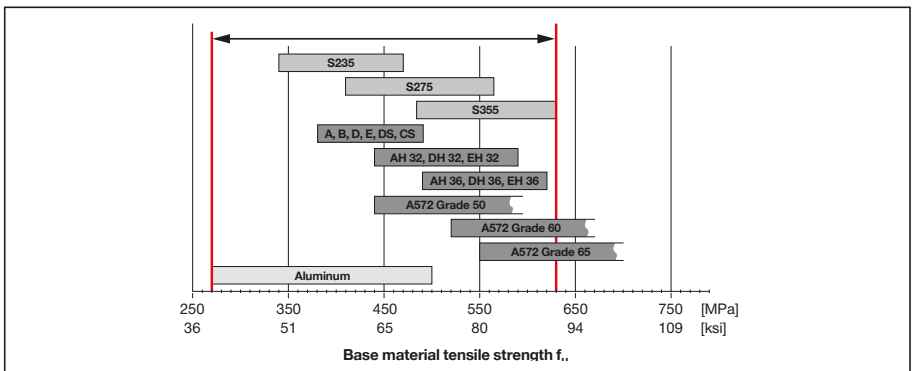

Corrosion information



- For more details, please refer to following technical document: Hilti Corrosion Handbook.

X-FCI-M is used to weather and mildly corrosive conditions, not suitable for coastal and offshore applications.

X-BT, X-BT-GR and S-BT-GR stainless steel fasteners is suitable for coastal and offshore environment. However, they can only be used for weather and mildly corrosive conditions once combining with X-FCI-M.

The coating of the carbon steel S-BT fasteners consists of an electroplated Zn-alloy for cathodic protection and a top coat for chemical resistance (Duplex-coating). The thickness of the coating is 35 µm. The use of this coating is limited to the corrosion category C1, C2 and C3 according the standard EN ISO 9223. For higher corrosion categories stainless steel fasteners should be used. In case of a drill through hole, rework of the coating on the back side of the plate/profile may be needed.

The intended use of the X-ST-GR fasteners comprises fastenings exposed to outdoor environments in mildly corrosive conditions where HDG coated parts are commonly specified or used. Not for use in atmospheres with chlorides (marine atmospheres) or in heavily polluted environments (e.g. sulphur dioxide).

System recommendation



- For more details, please refer to the chapter **Accessories and consumables compatibility** in the Direct Fastening Technology Manual (DFTM).

Fastener selection

Fastener	Item no.	W		L		Grating width		Grating height	
		mm (inch)	mm (inch)	mm (inch)	mm (inch)	a	mm (inch)	H _G	mm (inch)
X-FCI-M 28/32	2223485	40 (1.58")	22.5 (0.89")	23-38 (0.91"-1.50")	28-32 (1.10"-1.26")				
X-FCI-M 33/37	2223486	40 (1.58")	27.5 (1.08")	23-38 (0.91"-1.50")	33-37 (1.30"-1.46")				
X-FCI-M 38/42	2223487	40 (1.58")	32.5 (1.30")	23-38 (0.91"-1.50")	38-42 (1.50"-1.65")				
X-FCI-M 43/47	2223488	40 (1.58")	37.5 (1.48")	23-38 (0.91"-1.50")	43-47 (1.69"-1.85")				
X-FCI-M 48/52	2223489	40 (1.58")	42.5 (1.67")	23-38 (0.91"-1.50")	48-52 (1.89"-2.05")				
X-FCI-M 28/32 L	2223661	67 (2.64")	21 (0.83")	35-65 (1.38"-2.56")	28-32 (1.10"-1.26")				
X-FCI-M 33/37 L	2223662	67 (2.64")	26 (1.02")	35-65 (1.38"-2.56")	33-37 (1.30"-1.46")				
X-FCI-M 38/42 L	2223663	67 (2.64")	31 (1.22")	35-65 (1.38"-2.56")	38-42 (1.50"-1.65")				
X-FCI-M 43/47 L	2223664	67 (2.64")	36 (1.42")	35-65 (1.38"-2.56")	43-47 (1.69"-1.85")				
X-FCI-M 48/52 L	2223665	67 (2.64")	41 (1.61")	35-65 (1.38"-2.56")	48-52 (1.89"-2.05")				
X-FCI-M 28/32 C	2223667	32 (1.26")	21 (0.83")	30 + (1.18" +)	28-32 (1.10"-1.26")				
X-FCI-M 33/37 C	2223668	32 (1.26")	26 (1.02")	30 + (1.18" +)	33-37 (1.30"-1.46")				
X-FCI-M 38/42 C	2223669	32 (1.26")	31 (1.22")	30 + (1.18" +)	38-42 (1.50"-1.65")				
X-FCI-M 43/47 C	2223670	32 (1.26")	36 (1.42")	30 + (1.18" +)	43-47 (1.69"-1.85")				
X-FCI-M 48/52 C	2223671	32 (1.26")	41 (1.61")	30 + (1.18" +)	48-52 (1.89"-2.05")				

Grating width of X-FCI-M _/_ (L)

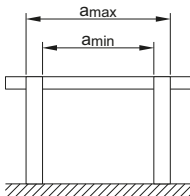

Grating height

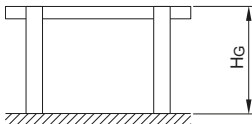

Grating width of X-FCI-M _/_ C

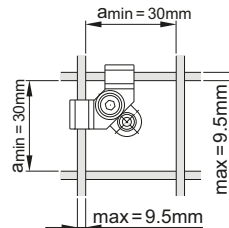

Threaded studs

Designation	Item no.
X-ST-GR M8/10 P8	2122460
X-BT M8-15-6 SN12-R	377074
X-BT-GR M8/7 SN 8	2194344
S-BT-GF M8/7 AN 6	2140527
S-BT-GR M8/7 SN 6	2140529
S-BT-GR M8/7 SN 6 AL	2140742

Cartridge selection and tool energy setting

- Fastener setting information (e.g. cartridge recommendation, tool power level adjustment, base material properties and fastener material properties) and installation information (e.g. quality assurance) are part of the corresponding product data sheet for fastener.

Material specifications and coatings

Fastener X-FCI-M	Saddle	Threaded stem	Washer
Material designation	DC0136	11SMNPB30+C	Stainless Steel 316
Coating	Duplex	Duplex	-

- Metal washer only mounted on X-FCI-M L and X-FCI-M C items
- Duplex: comparable to 45 µm HDG steel (480 h Salt spray test per DIN 50021)

Threaded studs

	X-BT M8-15-6 SN12-R			X-ST-GR	
	Shank ①	Threaded sleeve ②	Sealing ring of sealing washer ④	Shank	Threaded sleeve
Material	Stainless steel	X2CrNiMo17132	Elastomer,	P558	(A4 / AISI316)
designation	1.4462, CR 500 (A4 / AISI316)	X5CrNiMo17122+2H (A4 / AISI316)	black	(CrMnMo alloy)	
Coating	none	none		none	none

①) resistant to: UV, saltwater ozone, oil, grease

②) Zinc applied by electroplating. Intended for corrosion protection during shipment, storage, construction and service in protected environment. It is not adequate for protection against corrosion in outside or otherwise corrosive applications

Threaded studs

	S-BT- _R, X-BT-GR			S-BT- _F		
	Threaded Shank ①	SN 12-R washer ③	Sealing ring of sealing washer ④	Threaded Shank ②	AN 10-F washer ⑤	Sealing ring of sealing washer ④
Material	Stainless steel	Stainless steel	Elastomer,	Carbon steel	Aluminum	Elastomer,
designation	1.4462 (A4 / AISI316)	1.4404 (A4 / AISI316)	black	1038		black
Coating	Zinc ⑥	none	none	Duplex-coating	none	HDG

①) resistant to: UV, salt water, ozone, oil, grease

②) The surface of the S-BT stainless steel fasteners is zinc plated (anti-friction coating) in order to reduce the thread forming torque when the stud is screwed in into the base material.

③) only S-BT is coated, X-BT-GR is uncoated

thread forming torque when the stud is screwed in into the base material.

Quality assurance

Fastening inspection

X-BT M8-15-6 SN12-R

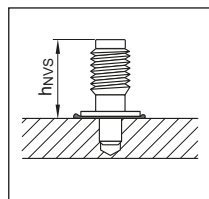

$h_{NVS} = 15.7 - 16.8 \text{ mm}$

X-BT-GR M8/7 SN 8

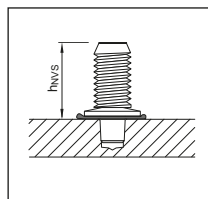

$h_{NVS} = 15.7 - 16.8 \text{ mm}$

X-ST-GR M8/10 P8

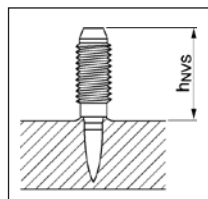

$h_{NVS} = 17.0 - 20.0 \text{ mm}$

S-BT- ___/7 ___ 6

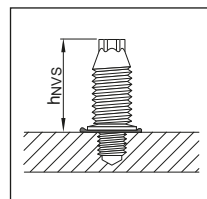

$h_{NVS} = 18.6 - 19.1 \text{ mm}$

Installation recommendation

Tightening torque for X-FCI-M, X-FCI-M-L

	Fastener: X-ST-GR, X-BT-GR, S-BT-GF, S-BT-GR
Element: X-FCI-M, X-FCI-M-L	4–5 Nm

Tightening tool recommendation for tightening with cordless screwdriver

Cordless screwdriver	Clutch type (stop detection)	Gear	Clutch
SF 2-A12	TRC	1	15
SF 2H-A12	TRC	1	15
SF 4-A22	TRC	1	4
SF 6-A22	ESC (SJ)	1	5
SF 6H-A22	ESC (SJ)	1	5
SF 8M-A22	TRC	3	5
SF 10W-A22	TRC	4	4-5



• Tool power level adjustment:

Gear:



Clutch:



- The setting of the torque via the Hilti screwdriver with torque release coupling (TRC) can change as the clutch wears over time. The specified torque setting is only a rough guide value and applies to a new Hilti screwdriver. To ensure recommended torque is applied, Hilti recommends the use of a calibrated torque wrench or the Hilti torque tool.
- The specified torque setting for the Hilti screw drivers with electronic slip clutch (ESC) is only a rough guide value as the ESC has 2 stop detections; Soft Joint (SJ) detection and Hard Joint (HJ) detection. The hard joint detection is activated due to drop in speed (fast stop) and can lead to a torque spike. The installation torque may vary depending on the user and the application. To ensure recommended torque is applied, Hilti recommends the use of a calibrated torque wrench or the Hilti torque tool.

Tightening tool recommendation for tightening with Hilti torque tool

Hilti torque tool

Torque tool S-BT 1/4" – 5 Nm

Tightening torque for X-FCI-M C

	Fastener: X-ST-GR, X-BT-GR, S-BT-GF, S-BT-GR
Element: X-FCI-M C	6–8 Nm

Tightening tool recommendation for tightening with cordless screwdriver

Cordless screwdriver	Clutch type (stop detection)	Gear	Clutch
SF 4-A22	TRC	1	9
SF 6-A22	ESC (SJ)	1	8
SF 6H-A22	ESC (SJ)	1	8
SF 8M-A22	TRC	3	7
SF 10W-A22	TRC	4	6



• Tool power level adjustment:

Gear:



Clutch:



- The setting of the torque via the Hilti screwdriver with torque release coupling (TRC) can change as the clutch wears over time. The specified torque setting is only a rough guide value and applies to a new Hilti screwdriver. To ensure recommended torque is applied, Hilti recommends the use of a calibrated torque wrench or the Hilti torque tool.
- The specified torque setting for the Hilti screw drivers with electronic slip clutch (ESC) is only a rough guide value as the ESC has 2 stop detections; Soft Joint (SJ) detection and Hard Joint (HJ) detection. The hard joint detection is activated due to drop in speed (fast stop) and can lead to a torque spike. The installation torque may vary depending on the user and the application. To ensure recommended torque is applied, Hilti recommends the use of a calibrated torque wrench or the Hilti torque tool.

Tightening tool recommendation for tightening with Hilti torque tool

Hilti torque tool
Torque tool X-BT 1/4" – 8 Nm

X-GR Grating fastening system

Product data

Dimensions

X-GR an X-GR-L

X-R 20-4.0 Zn P8

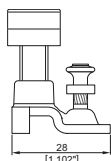
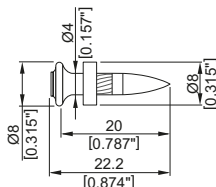
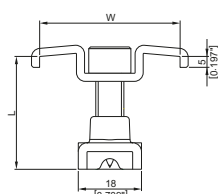

X-GR C

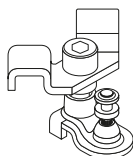
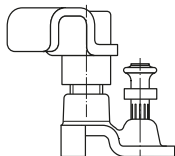

See Fastener selection for detailed dimensions

Material specifications

Screw:

Carbon steel

Zinc coating: Duplex* coated

Nail:

Stainless steel: CrMnMo Alloy and zinc coated

Upper part:

Carbon steel: DD11 or DC01

Zinc coating: Duplex* coated

Bottom part:

Carbon steel: S315MC or DC04

Zinc coating: Duplex* coated

*) 480 h salt spray test per DIN 50021 and 10 cycles
Kesternich test per DIN 50018/2.0 (comparable to 45 µm HDG steel)

Recommended fastening tools

DX 6 GR, DX 5 GR and DX 460 GR



- See system recommendation in the next pages.

Application

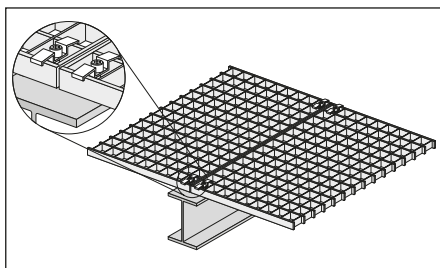

Fastening of grating



- For fastenings exposed to weather and mildly corrosive conditions.
- Not for use in marine atmospheres (upstream)!

Performance data

Recommended resistance under tension load

$$N_{rec} = 0.8 \text{ kN (180 lb)}$$

-  • Tensile loading is limited by plastic deformation of the saddle clip.
- X-GR resists shear by friction and is not suitable for explicit shear load designs.
- For X-GR C: In case of dynamic load $N_{rec} = 0.6 \text{ kN (135 lb)}$.

Application recommendation

Base material thickness

$$t_{II} \geq 4 \text{ mm (0.157")}$$

Fastened material thickness

Grating $H_G = 23\text{-}52 \text{ mm (0.91"-2.05")}$

height: Standard X-GR (X-GR 25/30, X-GR 1 1/4", X-GR 35/40):

See Fastener selection for detailed dimensions

Specials X-GR (X-GR 33/37, X-GR 43/47, X-GR 48/52, X-GR _/_ L and X-GR _/_ C):

Other dimensions special X-GR are available on demand

Grating opening types

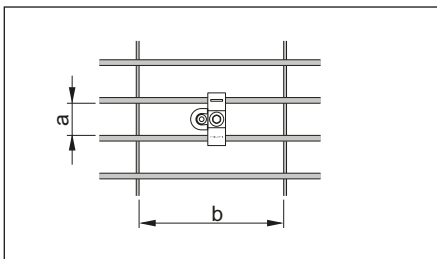

a : see Fastener selection

b $\geq 30 \text{ mm (1.18")}$

Fastener positioning in base material

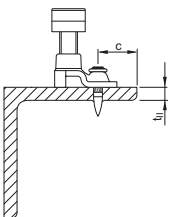

Edge distance: c $\geq 15 \text{ mm (0.59")}$

Application limits

Fastener: X-GR

Tool type: DX 460, DX 5, DX 6

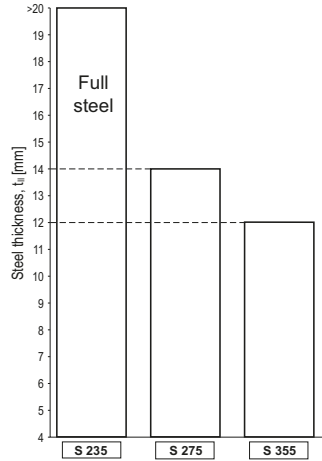
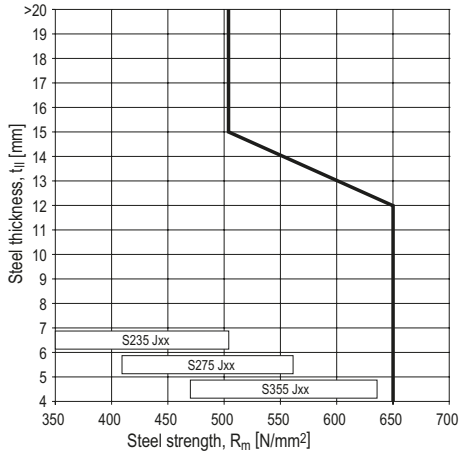

- S235: No application limit
- S275: Full coverage of grade up to 14mm base material thickness
- S355: Full coverage of grade up to 12mm base material thickness

Corrosion information



- For fastenings exposed to weather and mildly corrosive conditions.
- Not for use in marine atmospheres (upstream) or in heavily polluted environments.
- For more details, please refer to following technical document: Hilti Corrosion Handbook.

System recommendation



- For more details, please refer to the chapter **Accessories and consumables compatibility** in the Direct Fastening Technology Manual (DFTM).

Fastener selection

Fastener	Item no.	W	L	Grating width	Grating height
		mm (inch)	mm (inch)	a mm (inch)	H _G mm (inch)
X-GR 25/30	2106415 or 2154241	40 (1.58")	32 (1.26")	23-38 (0.91"-1.50")	25-30 (0.98"-1.18")
X-GR 1 1/4"	2106416 or 2154243	40 (1.58")	34 (1.34")	23-38 (0.91"-1.50")	27-32 (1.06"-1.26")
X-GR 35/40	2106417 or 2154242	40 (1.58")	42 (1.65")	23-38 (0.91"-1.50")	35-40 (1.38"-1.57")
X-GR 33/37	2222597	40 (1.58")	32 (1.26")	23-38 (0.91"-1.50")	33-37 (1.30"-1.46")
X-GR 43/47	2222598	40 (1.58")	42 (1.65")	23-38 (0.91"-1.50")	43-47 (1.69"-1.85")
X-GR 48/52	2222599	40 (1.58")	47 (1.85")	23-38 (0.91"-1.50")	48-52 (1.89"-2.05")
X-GR 23/27 L	2222640	65 (2.56")	32 (1.26")	35-65 (1.38"-2.56")	23-27 (0.91"-1.06")
X-GR 28/32 L	2222641	65 (2.56")	37 (1.46")	35-65 (1.38"-2.56")	28-32 (1.10"-1.26")
X-GR 33/37 L	2222642	65 (2.56")	42 (1.65")	35-65 (1.38"-2.56")	33-37 (1.30"-1.46")
X-GR 38/42 L	2222643	65 (2.56")	47 (1.85")	35-65 (1.38"-2.56")	38-42 (1.50"-1.65")
X-GR 43/47 L	2222644	65 (2.56")	52 (2.05")	35-65 (1.38"-2.56")	43-47 (1.69"-1.85")
X-GR 48/52 L	2222645	65 (2.56")	57 (2.24")	35-65 (1.38"-2.56")	48-52 (1.89"-2.05")
X-GR 23/27 C	2222646	32 (1.26")	32 (1.26")	30 + (1.18" +)	23-27 (0.91"-1.06")
X-GR 28/32 C	2222647	32 (1.26")	37 (1.46")	30 + (1.18" +)	28-32 (1.10"-1.26")
X-GR 33/37 C	2222648	32 (1.26")	42 (1.65")	30 + (1.18" +)	33-37 (1.30"-1.46")
X-GR 38/42 C	2222649	32 (1.26")	47 (1.85")	30 + (1.18" +)	38-42 (1.50"-1.65")
X-GR 43/47 C	2222650	32 (1.26")	52 (2.05")	30 + (1.18" +)	43-47 (1.69"-1.85")
X-GR 48/52 C	2222651	32 (1.26")	57 (2.24")	30 + (1.18" +)	48-52 (1.89"-2.05")

Grating width of X-GR _/_ and X-GR _/_ L

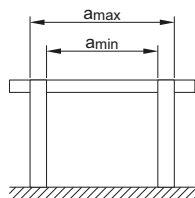

Grating height

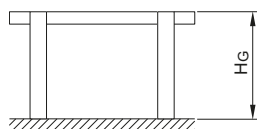

Grating width of X-GR _/_ C

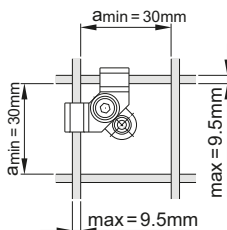

Cartridge recommendation

Base material		Cartridge color (tool power level)	
		Tool type: DX 6 GR Cartridge type: 6.8/11 M	Tool type: DX 5 GR, DX 460 GR Cartridge type: 6.8/11 M
S235	$4 \leq t_{II} \leq 6 \text{ mm}$	titanium ■ (4)	red ■ (1)
	$6 < t_{II} \leq 12 \text{ mm}$	titanium ■ (5-8), black ■ (6-7)	black ■ (1-3)
	$12 < t_{II} \leq 20 \text{ mm}$	black ■ (6-8)	black ■ (3-4)
S275	$4 \leq t_{II} \leq 6 \text{ mm}$	titanium ■ (4-6)	red ■ (1-2)
	$6 < t_{II} \leq 12 \text{ mm}$	titanium ■ (6-8), black ■ (6-7)	black ■ (2-3)
	$12 < t_{II} \leq 20 \text{ mm}$	black ■ (8)	black ■ (4)
S335	$4 \leq t_{II} \leq 6 \text{ mm}$	titanium ■ (4-7)	red ■ (1-3)
	$6 < t_{II} \leq 10 \text{ mm}$	titanium ■ (6-8), black ■ (6-8)	black ■ (2-4)
	$10 < t_{II} \leq 14 \text{ mm}$	black ■ (8)	black ■ (4)



- Tool power level adjustment by setting tests on site.
- Start tool energy selection with lowest recommended tool power level.
- Correct according requirement from chapter quality assurance.

Quality assurance

Fastening inspection

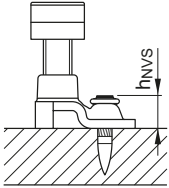

$$h_{NVS} = 7-10.5 \text{ mm (0.28"-0.41")}$$



- Observing the cartridge selection and tool energy setting typically leads to a stand-off between 9 and 10 mm.

Installation recommendation

Tightening torque for X-GR 25/30, X-GR 1 1/4", X-GR 35/40

	Fastener: Pre-mounted X-R 20
Element: X-GR 25/30, X-GR 1 1/4", X-GR 35/40	3–5 Nm

Tightening tool recommendation for tightening with cordless screwdriver

Cordless screwdriver	Clutch type (stop detection)	Gear	Clutch
SF 2-A12	TRC	1	15
SF 2H-A12	TRC	1	15
SF 4-A22	TRC	1	4
SF 6-A22	ESC (SJ)	1	5
SF 6H-A22	ESC (SJ)	1	5
SFC 14-A	TRC	2	6-7
SF 8M-A22	TRC	4	3-5
SF 10W-A22	TRC	4	3-5



- Tool power level adjustment:

Gear:



Clutch:



- The setting of the torque via the Hilti screwdriver with torque release coupling (TRC) can change as the clutch wears over time. The specified torque setting is only a rough guide value and applies to a new Hilti screwdriver. To ensure recommended torque is applied, Hilti recommends the use of a calibrated torque wrench or the Hilti torque tool.
- The specified torque setting for the Hilti screw drivers with electronic slip clutch (ESC) is only a rough guide value as the ESC has 2 stop detections; Soft Joint (SJ) detection and Hard Joint (HJ) detection. The hard joint detection is activated due to drop in speed (fast stop) and can lead to a torque spike. The installation torque may vary depending on the user and the application. To ensure recommended torque is applied, Hilti recommends the use of a calibrated torque wrench or the Hilti torque tool.

Tightening tool recommendation for tightening with Hilti torque tool

Hilti torque tool

Torque tool S-BT 1/4" – 5 Nm

Tightening torque for Installation recommendation for X-GR 33/37, X-GR 43/47, X-GR 48/52, X-GR _/_ L

	Fastener: Pre-mounted X-R 20
Element: X-GR 33/37, X-GR 43/47, X-GR 48/52, X-GR _/_ L	5-8 Nm

Tightening tool recommendation for tightening with cordless screwdriver

Cordless screwdriver	Clutch type (stop detection)	Gear	Clutch
SF 2-A12	TRC	1	15
SF 2H-A12	TRC	1	15
SF 4-A22	TRC	1	9
SF 6-A22	ESC (SJ)	1	8
SF 6H-A22	ESC (SJ)	1	8
SF 8M-A22	TRC	4	3-5
SF 10W-A22	TRC	4	3-5



• Tool power level adjustment:

Gear:



Clutch:



- The setting of the torque via the Hilti screwdriver with torque release coupling (TRC) can change as the clutch wears over time. The specified torque setting is only a rough guide value and applies to a new Hilti screwdriver. To ensure recommended torque is applied, Hilti recommends the use of a calibrated torque wrench or the Hilti torque tool.
- The specified torque setting for the Hilti screw drivers with electronic slip clutch (ESC) is only a rough guide value as the ESC has 2 stop detections; Soft Joint (SJ) detection and Hard Joint (HJ) detection. The hard joint detection is activated due to drop in speed (fast stop) and can lead to a torque spike. The installation torque may vary depending on the user and the application. To ensure recommended torque is applied, Hilti recommends the use of a calibrated torque wrench or the Hilti torque tool.

Tightening tool recommendation for tightening with Hilti torque tool

Hilti torque tool
Torque tool S-BT 1/4" – 5 Nm
Torque tool X-BT 1/4" – 8 Nm

Tightening torque for Installation recommendation for X-GR/_/_C

	Fastener: Pre-mounted X-R 20
Element: X-GR/_/_C	5-8 Nm

Tightening tool recommendation for tightening with cordless screwdriver

Cordless screwdriver	Clutch type (stop detection)	Gear	Clutch
SF 2-A12	TRC	1	15
SF 2H-A12	TRC	1	15
SF 4-A22	TRC	1	9
SF 6-A22	ESC (SJ)	1	8
SF 6H-A22	ESC (SJ)	1	8
SF 8M-A22	TRC	4	3-5
SF 10W-A22	TRC	4	3-5



- Tool power level adjustment:

Gear:



Clutch:



- The setting of the torque via the Hilti screwdriver with torque release coupling (TRC) can change as the clutch wears over time. The specified torque setting is only a rough guide value and applies to a new Hilti screwdriver. To ensure recommended torque is applied, Hilti recommends the use of a calibrated torque wrench or the Hilti torque tool.
- The specified torque setting for the Hilti screw drivers with electronic slip clutch (ESC) is only a rough guide value as the ESC has 2 stop detections; Soft Joint (SJ) detection and Hard Joint (HJ) detection. The hard joint detection is activated due to drop in speed (fast stop) and can lead to a torque spike. The installation torque may vary depending on the user and the application. To ensure recommended torque is applied, Hilti recommends the use of a calibrated torque wrench or the Hilti torque tool.

Tightening tool recommendation for tightening with Hilti torque tool

Hilti torque tool

Torque tool S-BT 1/4" – 5 Nm

Torque tool X-BT 1/4" – 8 Nm

X-FCS-R Grating element

X-FCS-R Grating element designation

X	-	FCS	-	R	3	25
Technology		Application		Material	Number of saddles	Bar spacing

Technology:

X | DX solution

Application:

FCS | Grating element

Material:

R | Stainless steel

Number of saddles:

3 | Three fastening saddles

4 | Four fastening saddles

Bar spacing:

25 | Bar spacing

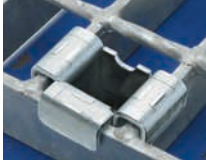
Product data
X-FCS-R-3-25

X-FCS-R-4-25

Product description

- Grating fastening system is an approved system for securing gratings under tension and shear load
- Grating element is available with three saddles for rectangular gratings and four saddles for square gratings
- Grating element X-FCS-R can be combined with various fasteners

Grating fastening system

Grating element	Fastener		
	X-BT M8-15-6 SN 12 R	X-BT-GR M8/7 SN 8	S-BT-GR M8/7 SN 6
X-FCS-R-3-25	●	●	●
X-FCS-R-4-25	●	●	●

Material specification and material properties
Material specification and material properties for stainless steel parts

Grating fastening system	Material	Coating	Steel grade		Corrosion resistance	
			acc. to EN 10088	ASTM AISI SAE		
X-FCS-R-3-25	Saddle	Stainless steel	none	1.4404	316 L	CRC III
X-FCS-R-3-25	Threaded nut	Stainless steel	none	1.4401	316	CRC III
X-FCS-R-4-25	Saddle	Stainless steel	none	1.4404	316 L	CRC III
X-FCS-R-4-25	Threaded nut	Stainless steel	none	1.4401	316	CRC III

Grating fastening system recommendation under various environmental conditions

Environmental condition		Grating fastening system		
		X-FCS-R combined with X-BT M8-15-6 SN 12 R	X-FCS-R combined with X-BT-GR M8/7 SN8	X-FCS-R combined with S-BT-GR M8/7 SN6
	Dry indoor	■	■	■
	Indoor with temporary condensation	■	■	■
	Outdoor with low pollution	■	■	■
	Outdoor with moderate concentration of pollutants	■	■	■
	Coastal areas	■	■	■
	Outdoor, areas with heavy industrial pollution	■	■	■
	Close proximity to roads	■	■	■
	Special application	Please contact our Expert Hilti Engineers to support recommendation		
	Special application			

■ = Suitable for corrosion prevention

■ = Feasible for corrosion prevention

Further information can be found in following Hilti brochures:

- X-BT Threaded Fastener Specification
- New Generation X-BT-GR, X-BT-MR and X-BT-ER Threaded Fastener Specification
- S-BT Threaded Fastener Specification
- Corrosion handbook

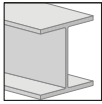
Base material

Steel

Load condition



Static/quasi static

Approval/certificate

Authority	American Bureau of Shipping	Bureau Veritas	Det Norske Veritas Germanischer Lloyd	Lloyd's Register	RINA

i Information presented in this product data sheet is based on Hilti Technical Data. For the specific application please refer to the corresponding approval/certificate.

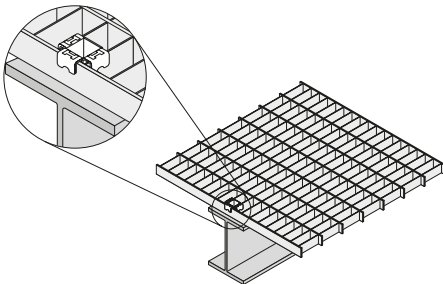
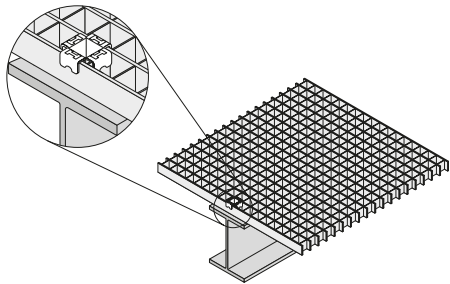
i Approvals/certificates available for following grating fastening systems:
 X-FCS-R-3-25 (Saddles connected to bearing bar: 3)
 X-FCS-R-4-25 (Saddles connected to bearing bar: 4)

Application
Securing rectangular grating

Securing square grating

Grating element

Grating element definition

X-FCS-R-3-25

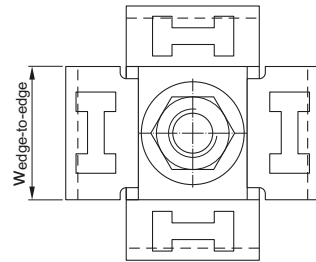
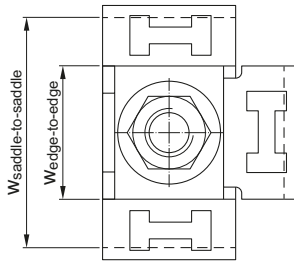
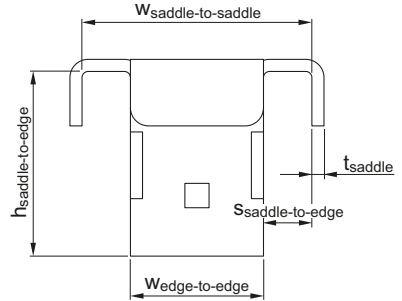
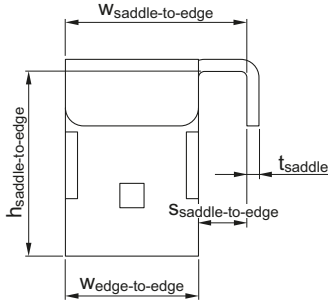
X-FCS-R-4-25



$W_{\text{saddle-to-edge}}$ = Width between saddle and edge

$W_{\text{saddle-to-saddle}}$ = Width between saddles

$W_{\text{edge-to-edge}}$ = Grating element width

$S_{\text{saddle-to-edge}}$ = Spacing between saddle and grating edge

t_{saddle} = Saddle thickness

$h_{\text{saddle-to-edge}}$ = Grating element height

Grating element definition

Grating element	Saddle width	Grating element width	Spacing between saddle and grating element	Saddle thickness	Grating element height
	$W_{\text{saddle-to-edge}}$ $W_{\text{saddle-to-saddle}}$	$W_{\text{edge-to-edge}}$	$S_{\text{saddle-to-saddle}}$	t_{saddle}	$h_{\text{saddle-to-edge}}$
X-FCS-R-3-25 31/35	30 mm	22 mm	8 mm	2 mm	30.5 mm
X-FCS-R-3-25 37/41	30 mm	22 mm	8 mm	2 mm	36.5 mm
X-FCS-R-4-25 31/35	38 mm	22 mm	8 mm	2 mm	30.5 mm
X-FCS-R-4-25 37/41	38 mm	22 mm	8 mm	2 mm	36.5 mm

Grating fastening

Grating element for
rectangular grating fastening

X-FCS-R-3-25 31/35
X-FCS-R-3-25 37/41

3 saddles
connected to bearing bar

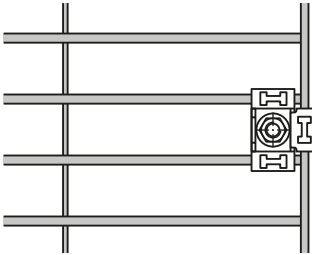

Grating element for
square grating fastening

X-FCS-R-4-25 31/35
X-FCS-R-4-25 37/41

4 saddles
connected to bearing bar

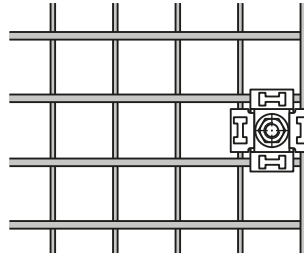

Grating definition

Example: Fastening with X-BT

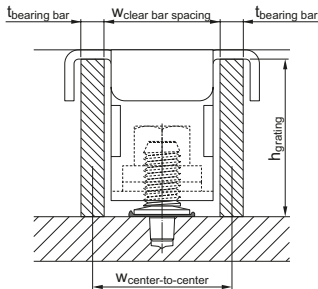

$t_{\text{bearing bar}}$ Bearing bar thickness
 $W_{\text{clear bar spacing}}$ Clear bar spacing
 $W_{\text{center-to-center}}$ Center-to-center bar spacing
 h_{grating} Grating height

Grating dimension

Grating element	Bearing bar thickness	Clear bar spacing	Center-to-center bar spacing	Minimum grating height	Maximum grating height
	$t_{\text{bearing bar}}$	$W_{\text{bearing bar}}$	$w_{\text{center-to-center}}$	$h_{\text{grating, min}}$	$h_{\text{grating, max}}$
X-FCS-R-3-25 31/35	5 mm	25 mm	30 mm	31 mm	35 mm
X-FCS-R-3-25 37/41	5 mm	25 mm	30 mm	37 mm	41 mm
X-FCS-R-4-25 31/35	5 mm	25 mm	30 mm	31 mm	35 mm
X-FCS-R-4-25 37/41	5 mm	25 mm	30 mm	37 mm	41 mm

Load data

Design concept for single fastening points under tension and shear load

Recommended resistance under tension load	Design resistance under tension load
$N_{rec} = \min \{N_{rec, \text{grating element}}; N_{rec, \text{fastener}}\}$	$N_{Rd} = \min \{N_{Rd, \text{grating element}}; N_{Rd, \text{fastener}}\}$
Recommended resistance under shear load	Design resistance under shear load
$V_{rec} = \min \{V_{rec, \text{grating element}}; V_{rec, \text{fastener}}\}$	$V_{Rd} = \min \{V_{Rd, \text{grating element}}; V_{Rd, \text{fastener}}\}$

Design concept for load interaction

Recommended resistance under combined load	Design resistance under combined load
$\frac{N}{N_{rec}} + \frac{V}{V_{rec}} \leq 1.2$	$\frac{N_{Sd}}{N_{Rd}} + \frac{V_{Sd}}{V_{Rd}} \leq 1.2$

N_{rec} = Recommended resistance under tension load for grating fastening system

$N_{rec, \text{grating element}}$ = Recommended resistance under tension load for grating element

$N_{rec, \text{fastener}}$ = Recommended resistance under tension load for fastener

V_{rec} = Recommended resistance under shear load for grating fastening system

$V_{rec, \text{grating element}}$ = Recommended resistance under shear load for grating element

$V_{rec, \text{fastener}}$ = Recommended resistance under shear load for fastener

N_{Sd} = Design tension load

N_{Rd} = Design resistance under tension load for grating fastening system

$N_{Rd, \text{grating element}}$ = Design resistance under tension load for grating element

$N_{Rd, \text{fastener}}$ = Design resistance under tension load for fastener

V_{Sd} = Design shear load

V_{Rd} = Design resistance under shear load for grating fastening system

$V_{Rd, \text{grating element}}$ = Design resistance under shear load for grating element

$V_{Rd, \text{fastener}}$ = Design resistance under shear load for fastener

Shear load direction definition for single fastening points

Grating element	Saddles connected to bearing bar	Shear load direction		
		Load direction a	Load direction b	Load direction c
X-FCS-R-3-25	3			
X-FCS-R-3-25	2		Not admissible	
			Not admissible	
				Contact connection of 2 saddles to the bearing bar is required
X-FCS-R-4-25	4			

Recommended resistance under tension and shear load for single fastening points

Grating element	Saddles connected to bearing bars	Base material (EN 10025-2)	Base material (ASTM AISI SAE)	Resistance under tension and shear load	Base material thickness		
					$t_{fl} \geq 8 \text{ mm}$	$t_{fl} \geq 8 \text{ mm}$	$t_{fl} \geq 6 \text{ mm}$
					X-BT M8-15-6 SN 12-R	X-BT-GR M8/7 SN 8	S-BT-GR M8/7 SN 6
X-FCS-R-3-25	3	S235	A36	N_{rec}	1.8 kN	2.6 kN	1.8 kN
				$V_{rec, \text{direction a}}$	2.6 kN	4.3 kN	2.6 kN
				$V_{rec, \text{direction b}}$	0.8 kN	0.8 kN	0.8 kN
				$V_{rec, \text{direction c}}$	2.6 kN	4.3 kN	2.6 kN
		S355	Grade 50	N_{rec}	2.3 kN	2.6 kN	2.3 kN
				$V_{rec, \text{direction a}}$	3.2 kN	4.3 kN	3.2 kN
				$V_{rec, \text{direction b}}$	0.8 kN	0.8 kN	0.8 kN
				$V_{rec, \text{direction c}}$	3.2 kN	4.3 kN	3.2 kN
X-FCS-R-3-25	2	S235	A36	N_{rec}	–	1.7 kN	–
				$V_{rec, \text{direction a}}$	–	4.3 kN	–
				$V_{rec, \text{direction b}}$	–	–	–
				$V_{rec, \text{direction c}}$	–	4.3 kN	–
		S355	Grade 50	N_{rec}	–	1.7 kN	–
				$V_{rec, \text{direction a}}$	–	4.3 kN	–
				$V_{rec, \text{direction b}}$	–	–	–
				$V_{rec, \text{direction c}}$	–	4.3 kN	–
X-FCS-R-4-25	4	S235	A36	N_{rec}	1.8 kN	2.6 kN	1.8 kN
				$V_{rec, \text{direction a}}$	2.6 kN	4.3 kN	2.6 kN
				$V_{rec, \text{direction b}}$	2.6 kN	4.3 kN	2.6 kN
				$V_{rec, \text{direction c}}$	2.6 kN	4.3 kN	2.6 kN
		S355	Grade 50	N_{rec}	2.3 kN	2.6 kN	2.3 kN
				$V_{rec, \text{direction a}}$	3.2 kN	4.3 kN	3.2 kN
				$V_{rec, \text{direction b}}$	3.2 kN	4.3 kN	3.2 kN
				$V_{rec, \text{direction c}}$	3.2 kN	4.3 kN	3.2 kN

Design resistance under tension and shear load for single fastening points

Grating element	Saddles connected to bearing bars	Base material (EN 10025-2)	Base material (ASTM AISI SAE)	Resistance under tension and shear load	Base material thickness		
					$t_{II} \geq 8 \text{ mm}$	$t_{II} \geq 8 \text{ mm}$	$t_{II} \geq 6 \text{ mm}$
					X-BT M8-15-6 SN 12-R	X-BT-GR M8/7 SN 8	S-BT-GR M8/7 SN 6
X-FCS-R-3-25	3	S235	A36	N_{Rd}	2.5 kN	3.6 kN	2.5 kN
				$V_{Rd, \text{direction a}}$	3.6 kN	6.0 kN	3.6 kN
				$V_{Rd, \text{direction b}}$	1.1 kN	1.1 kN	1.1 kN
				$V_{Rd, \text{direction c}}$	3.6 kN	6.0 kN	3.6 kN
		S355	Grade 50	N_{Rd}	3.2 kN	3.6 kN	3.2 kN
				$V_{Rd, \text{direction a}}$	4.5 kN	6.0 kN	4.5 kN
				$V_{Rd, \text{direction b}}$	1.1 kN	1.1 kN	1.1 kN
				$V_{Rd, \text{direction c}}$	4.5 kN	6.0 kN	4.5 kN
X-FCS-R-3-25	2	S235	A36	N_{Rd}	–	2.2 kN	–
				$V_{Rd, \text{direction a}}$	–	6.0 kN	–
				$V_{Rd, \text{direction b}}$	–	–	–
				$V_{Rd, \text{direction c}}$	–	6.0 kN	–
		S355	Grade 50	N_{Rd}	–	2.2 kN	–
				$V_{Rd, \text{direction a}}$	–	6.0 kN	–
				$V_{Rd, \text{direction b}}$	–	–	–
				$V_{Rd, \text{direction c}}$	–	6.0 kN	–
X-FCS-R-4-25	4	S235	A36	N_{Rd}	2.5 kN	3.6 kN	2.5 kN
				$V_{Rd, \text{direction a}}$	3.6 kN	6.0 kN	3.6 kN
				$V_{Rd, \text{direction b}}$	3.6 kN	6.0 kN	3.6 kN
				$V_{Rd, \text{direction c}}$	3.6 kN	6.0 kN	3.6 kN
		S355	Grade 50	N_{Rd}	3.2 kN	3.6 kN	3.2 kN
				$V_{Rd, \text{direction a}}$	4.5 kN	6.0 kN	4.5 kN
				$V_{Rd, \text{direction b}}$	4.5 kN	6.0 kN	4.5 kN
				$V_{Rd, \text{direction c}}$	4.5 kN	6.0 kN	4.5 kN

Design concept for multiple fastening points under tension and shear load

Example: Recommended resistance for rectangular grating under symmetrical load in x-axis

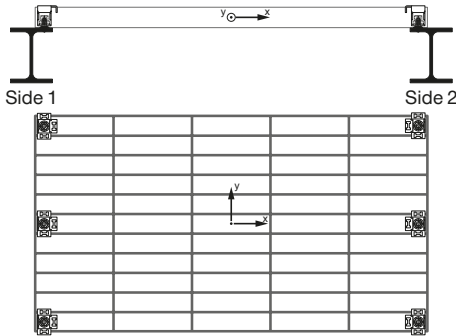

Grating element: X-FCS-R-3-25
 Saddles connected to bearing bar: 2
 Fastener: X-BT M8-15-6 SN 12 R
 Base material: S235
 Base material thickness: $t_{II} = 8 \text{ mm}$

$$N_{\text{rec, GR}} = (n_1 + n_2) \cdot N_{\text{rec}}$$

$$= 6 \cdot 1.8 = 10.8 \text{ kN}$$

$$V_{\text{rec, GR, y}} = 2 \cdot \min\{n_1; n_2\} \cdot V_{\text{rec, a}}$$

$$= 2 \cdot 3 \cdot 2.6 = 15.6 \text{ kN}$$

$$V_{\text{rec, GR, x}} = n_1 \cdot V_{\text{rec, c}}$$

$$= 3 \cdot 2.6 = 7.8 \text{ kN}$$

X-FCS-R-3-25 per side of rectangular grating:
 Number of X-FCS-R side 1: $n_1 = 3$
 Number of X-FCS-R side 2: $n_2 = 3$

Note: Load resistance in direction b is neglected due to lower stiffness in direction b compared to direction c.

Example: Design resistance for square grating under symmetrical load in x-axis

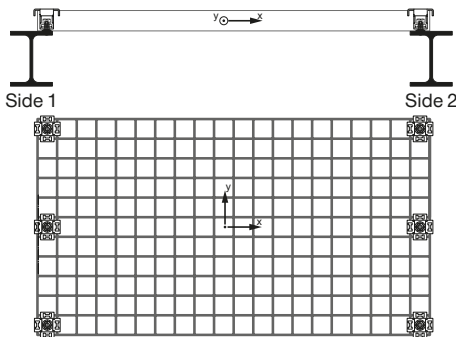

Grating element: X-FCS-R-4-25
 Saddles connected to bearing bar: 4
 Fastener: S-BT-GR M8/7 SN 6
 Base material: S355
 Base material thickness: $t_{II} = 6 \text{ mm}$

$$N_{\text{Rd, GR}} = (n_1 + n_2) \cdot N_{\text{Rd}}$$

$$= 6 \cdot 3.2 = 19.2 \text{ kN}$$

$$V_{\text{rec, GR, y}} = 2 \cdot \min\{n_1; n_2\} \cdot V_{\text{rec, a}}$$

$$= 2 \cdot 3 \cdot 4.5 = 27.0 \text{ kN}$$

$$V_{\text{rec, GR, x}} = (n_1 + n_2) \cdot V_{\text{rec, c}}$$

$$= 6 \cdot 4.5 = 27.0 \text{ kN}$$

X-FCS-R-4-25 per side of rectangular grating:
 Number of X-FCS-R side 1: $n_1 = 3$
 Number of X-FCS-R side 2: $n_2 = 3$

Note: Load resistance in direction b is neglected due to lower stiffness in direction b compared to direction c.

System recommendation

System recommendation for tightening grating element

Grating element	Fastener	Torque moment	Tightening tool	Nut setter
X-FCS-R-3-25	X-BT M8-15-6 SN 12-R	8 Nm	SBT 4-A22 ¹⁾ SFC 22-A ¹⁾	S-NS 12 C 95/3 3/4"
X-FCS-R-4-25	X-BT-GR M8/7 SN 8	20 Nm		
	S-BT-GR M8/7 SN 6	8 Nm		

¹⁾ Other tightening tools with torque moment control function can be used.

Fastener setting and installation information

Fastener setting information (e.g. base material properties, fastened material properties and setting energy) and installation information (e.g. quality assurance) are part of the corresponding Product Data Sheet for fasteners.

Grating fastening system component

Component	Designation	Item no.
Grating element	X-FCS-R-3-25 31/35	2198296
Grating element	X-FCS-R-3-25 37/41	2198297
Grating element	X-FCS-R-4-25 31/35	2198298
Grating element	X-FCS-R-4-25 37/41	2198299
Fastener	X-BT M8-15-6 SN 12 R	377074
Fastener	X-BT-GR M8/7 SN 8	2194344
Fastener	S-BT-GR M8/7 SN 6	2140529

X-PGR-RU Grating fastening system (pre-drilled)

Product data

Dimensions

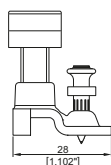
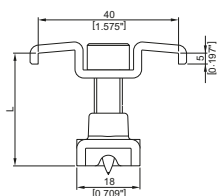
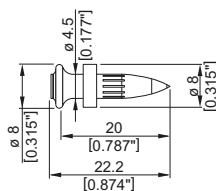
X-PGR-RU

X-CR 20-4.5R P8

Material specifications

Screw:

Carbon steel

Zinc coating: Duplex* coated

Nail:

Stainless steel: CrNiMo Alloy

Upper part:

Carbon steel: DD11

Zinc coating: Duplex* coated

Bottom part:

Carbon steel: S315MC

Zinc coating: Duplex* coated

*) 480 h salt spray test per DIN 50021 and 10 cycles
 Kesternich test per DIN 50018/2.0 (comparable to
 45 µm HDG steel)

Recommended fastening tools

DX 6 GR, DX 5 GR and DX 460 GR

• See fastener program in the next pages.

Application

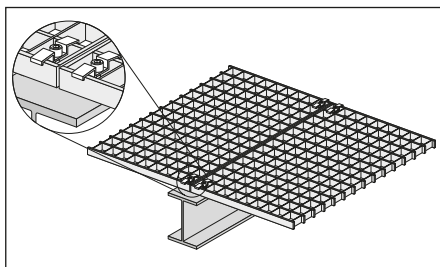

Fastening of grating

For fastenings exposed to weather and mildly corrosive conditions.

Not for use in marine atmospheres (upstream)!

Performance data

Recommended resistance under tension load

$$N_{rec} = 0.8 \text{ kN (180 lb)}$$

- Tensile loading is limited by plastic deformation of the saddle clip.
- X-PGR-RU resists shear by friction and is not suitable for explicit shear load designs.

Application recommendation

Base material thickness

$$t_{II} \geq 6 \text{ mm (0.24")}$$

Fastened material thickness

$$\text{Grating height: } H_G = 25\text{--}40 \text{ mm (0.98"–1.57")}$$

Grating opening types

Bearing bar spacing (a)

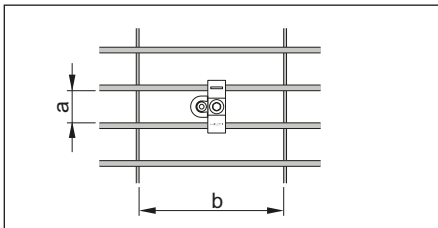

a from 25 to 32 mm (1" to 1 1/4")

Cross bar spacing (b)

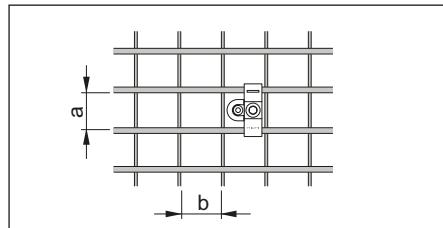

b ≥ 30 mm (1.18")

Fastener positioning in base material

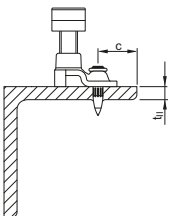

Edge distance: $c \geq 15 \text{ mm (0.59")}$

Application limits

X-PGR-RU with DX 460 GR, DX 5 GR, DX 6 GR

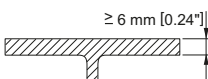

- pre-drilled
- base material thickness: $t_{II} \geq 6 \text{ mm [0.24"]}$
- steel strength: $350 \text{ N/mm}^2 \leq R_m \leq 630 \text{ N/mm}^2$

Corrosion information

-  • For fastenings exposed to weather and mildly corrosive conditions.
- Not for use in marine atmospheres (upstream) or in heavily polluted environments.
- For more details, please refer to following technical document:
Hilti Corrosion Handbook.

System recommendation

-  • For more details, please refer to the chapter **Accessories and consumables compatibility** in the Direct Fastening Technology Manual (DFTM).

Fastener program

Fastener	Item no.	L mm (inch)	Grating height mm (inch)
X-PGR-RU 25/30	2061313	32 (1.26")	25–30 (0.98"–1.18")
X-PGR-RU 1 1/4"	2061314	34 (1.34")	27–32 (1.06"–1.26")
X-PGR-RU 35/40	2061315	42 (1.65")	35–40 (1.38"–1.57")

Cartridge recommendation

Base material		Cartridge color (tool power level)	
		Tool type: DX 6 GR	Tool type: DX 5 GR, DX 460 GR
		Cartridge type: 6.8/11 M	Cartridge type: 6.8/11 M
S235, S275, S355	$6 \leq t_{\parallel} \leq 20 \text{ mm}$	titanium ■ (4-6)	red ■ (1-2)

-  • Tool power level adjustment by setting tests on site.
- Start tool energy selection with lowest recommended tool power level.
- Correct according requirement from chapter quality assurance.

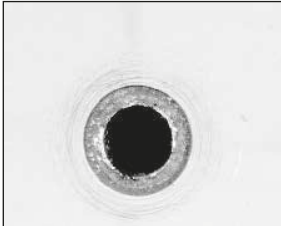
Quality assurance
Pre-drill

Pre-drill with TX-PGR-RU-4/10-93 step shank drill bit (Item no. 2061802), until shoulder grinds a shiny ring (to ensure proper drilling depth).

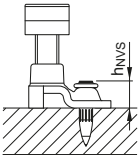
Fastening inspection

$h_{NVS} = 8-10 \text{ mm (0.31"-0.39")}$

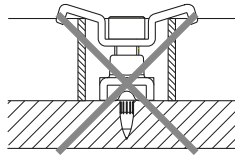

The saddle of the fastener should not be bent, see installation instruction above.

These are abbreviated instructions which may vary by application.
ALWAYS review/follow the instructions accompanying the product.

Installation recommendation
Tightening torque

Element: X-PGR-RU	Fastener: Pre-mounted X-CR 20 3-5 Nm
-------------------	---

Tightening tool recommendation for tightening with cordless screwdriver

Cordless screwdriver	Clutch type (stop detection)	Gear	Clutch
SF 2-A12	TRC	1	15
SF 2H-A12	TRC	1	15
SF 4-A22	TRC	1	4
SF 6-A22	ESC (SJ)	1	5
SF 6H-A22	ESC (SJ)	1	5
SFC 14-A	TRC	1	4-7
SF 18-A	TRC	1	3-5
SFC 18-A	TRC	1	3-5
SFC 22-A	TRC	1	3-5
SBT 4-A22	TRC	1	3-5



- Tool power level adjustment:

Gear:



Clutch:



- The setting of the torque via the Hilti screwdriver with torque release coupling (TRC) can change as the clutch wears over time. The specified torque setting is only a rough guide value and applies to a new Hilti screwdriver. To ensure recommended torque is applied, Hilti recommends the use of a calibrated torque wrench or the Hilti torque tool.
- The specified torque setting for the Hilti screw drivers with electronic slip clutch (ESC) is only a rough guide value as the ESC has 2 stop detections; Soft Joint (SJ) detection and Hard Joint (HJ) detection. The hard joint detection is activated due to drop in speed (fast stop) and can lead to a torque spike. The installation torque may vary depending on the user and the application. To ensure recommended torque is applied, Hilti recommends the use of a calibrated torque wrench or the Hilti torque tool.

Tightening tool recommendation for tightening with Hilti torque tool

Hilti torque tool

Torque tool S-BT 1/4" – 5 Nm

X-MGR Grating fastening system

Product data

Dimensions

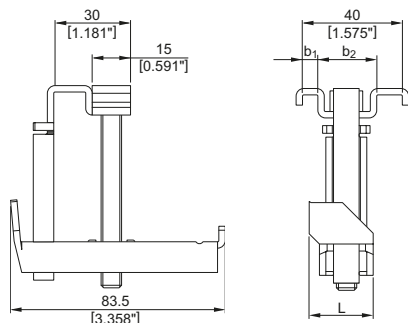

Material specifications

Screw:	
Carbon steel	
Zinc coating:	60 µm HDG
Upper part:	
Carbon steel:	SPCC-S
Zinc coating:	65 µm HDG
Bottom part:	
Carbon steel:	SPCC-S
Zinc coating:	65 µm HDG
Nut:	
Carbon steel	
Zinc coating:	45 µm HDG
Nut-holder:	
Stainless steel:	SS304

Recommended fastening tools

SF 121-A, SF150-A, SF 14, SFC 14-A, SF 18-A, SFC 18-A, SF 22-A

- For more details, please refer to **X-MGR fastener program** and to the chapter **Accessories and consumables compatibility** in the Direct Fastening Technology Manual (DFTM).

Applications

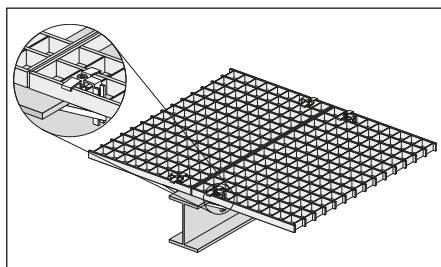

Fixing of grating

For fastenings exposed to weather and mildly corrosive conditions.
Not for use in marine atmospheres (upstream)!

Performance data

Recommended tensile loads

$N_{rec} = 0.6 \text{ kN (135 lb)}$

- Tensile loading is limited by plastic deformation of the saddle clip.
- X-MGR resists shear by friction and is not suitable for explicit shear load designs.

Application recommendation

Thickness of base material

$t_{II} = 3 - 25 \text{ mm (0.118 - 0.984")}$

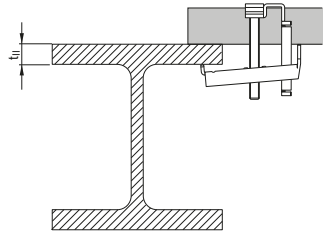

Thickness of fastened material

Grating height:

$H_G = 25 - 40 \text{ mm (0.98 - 1.57")}$

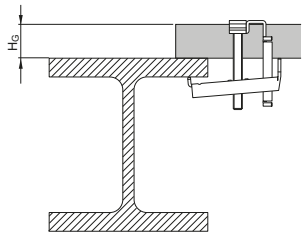

Total fastening height

$H_G + t_{II} \leq 65 \text{ mm (2.56")}$

Grating opening types

Fastener	a mm (inch)	b mm (inch)	c mm (inch)
X-MGR M60	30 (1.18")	$\geq 30 (1.18")$	$\leq 3 (0.118")$
X-MGR W60	25 (0.98")	$\geq 30 (1.18")$	$\leq 4.8 (3/16")$

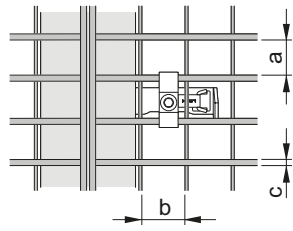

Spacing and edge distances

No general restriction exists.

Corrosion information

For fastenings exposed to weather and mildly corrosive conditions. **Not for use in marine atmosphere (Upstream)** or in heavily polluted environment.

Fastener program and system recommendation

Fastener program

Fastener	Item-no.	Steel flange thickness t_{fl} mm (inch)	Grating height mm (inch)	Fastening tool
X-MRG-M60	384233	3-25 (0.12"-0.98")	25-40 (0.98"-1.57")	SF 121-A, SF 150-A
X-MRG-W60	384234	3-25 (0.12"-0.98")	25-40 (0.98"-1.57")	SF 121-A, SF 150-A

Quality assurance

Fastening inspection

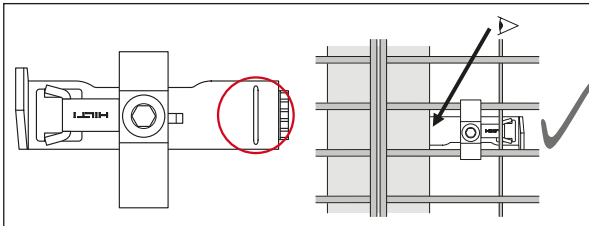

The sign on the clip has to be positioned under the steel flange

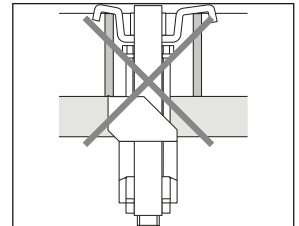

The saddle of the fastener should not be bent, see installation instructions below.

Installation recommendation

Tightening torque

Element: X-MGR	5–8 Nm
----------------	--------

Tightening tool recommendation for tightening with cordless screwdriver

Cordless screwdriver	Clutch type (stop detection)	Gear	Clutch
SF 2-A12	TRC	1	15
SF 2H-A12	TRC	1	15
SF 4-A22	TRC	1	8
SF 6-A22	ESC (SJ)	1	7
SF 6H-A22	ESC (SJ)	1	7
SFC 14-A	TRC	1	6-10
SF 18-A	TRC	1	5-8
SFC 18-A	TRC	1	5-8
SF 22-A	TRC	1	5-8
SFC 22-A	TRC	1	4-5
SBT 4-A22	TRC	1	5-7



• Tool power level adjustment:

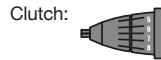

- The setting of the torque via the Hilti screwdriver with torque release coupling (TRC) can change as the clutch wears over time. The specified torque setting is only a rough guide value and applies to a new Hilti screwdriver. To ensure recommended torque is applied, Hilti recommends the use of a calibrated torque wrench or the Hilti torque tool.
- The specified torque setting for the Hilti screw drivers with electronic slip clutch (ESC) is only a rough guide value as the ESC has 2 stop detections; Soft Joint (SJ) detection and Hard Joint (HJ) detection. The hard joint detection is activated due to drop in speed (fast stop) and can lead to a torque spike. The installation torque may vary depending on the user and the application. To ensure recommended torque is applied, Hilti recommends the use of a calibrated torque wrench or the Hilti torque tool.

Tightening tool recommendation for tightening with Hilti torque tool

Hilti torque tool
Torque tool S-BT 1/4" – 5 Nm
Torque tool X-BT 1/4" – 8 Nm

X-FCP Checker plate fastening system

Product data

Dimensions

X-FCP-R 5/10

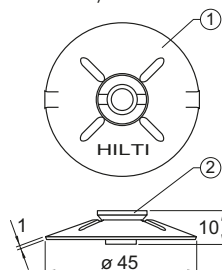

X-FCP-F 5/10

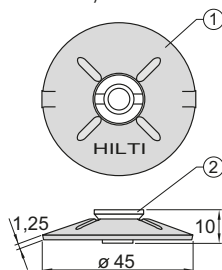

Material specifications

See fastener selection for more details.

Recommended fastening tools

- See fastener program in the next pages.

Approvals

LR: X-FCP

ABS, LR: X-FCP-R

ABS: X-FCP-F

- Not all information presented in this product data sheet might be subject to approval/certificate content. Please refer to approval/certificate for further information.

X-FCP Sealing ring

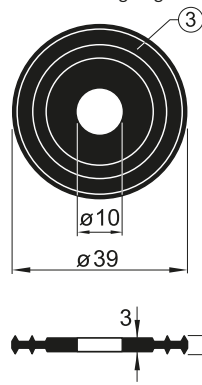

X-ST-GR M8/5 P8

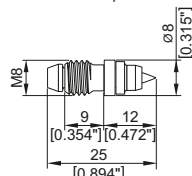

X-CRM8-15-12 FP10

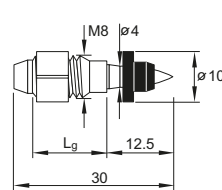

X-CRM8-9-12 P8

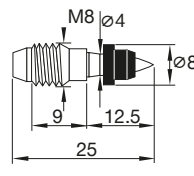

X-ST-GR M8/10 P8

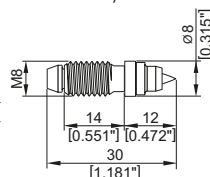

X-CRM8-9-12 FP10

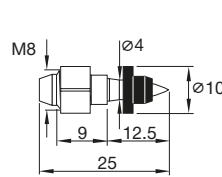

X-CRM8-15-12 P8

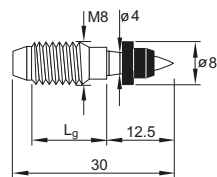

Application

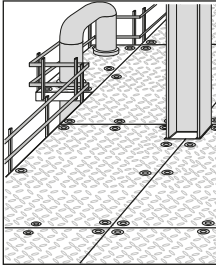

Checker plate

Application areas for X-FCP system

X-FCP-R

-  • Marine, offshore, petrochemical, calorific (coal, oil) power plants, etc.
- Not for use in automobile tunnels, swimming pools or similar environments.

X-FCP-F

-  • Indoors, mildly corrosive environment, or for limited lifetime use.
- Not for use in marine atmosphere or in heavily polluted environment.

Sealing ring

-  • Drip-through of water/oil needs to be prevented.

Performance data

Recommended resistance under tension load

$$N_{rec} = 1.8 \text{ [kN]}$$

-  • Limited by the strength of the X-CRM8 and X-ST-GR threaded stud.
- Recommended loads are valid for fastenings of steel and aluminium with 20 mm pre-drilling.
- X-FCP-F and X-FCP-R are not intended for shear loading.

Application recommendation

Base material thickness

X-CRM8 , X-ST-GR

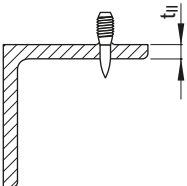

Steel thickness: $t_{II} \geq 6 \text{ mm}$

Fastened material thickness

Thickness of checker plates:
 $t_1 \approx 5.0\text{--}13.0 \text{ mm}$

Fastener positioning in base material

X-CRM8, X-ST-GR

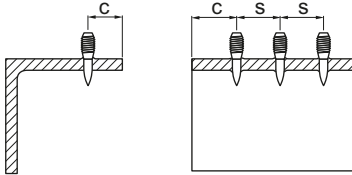

Edge distances: $c \geq 15 \text{ mm}$

Spacing: $s \geq 15 \text{ mm}$

Application limits for X-CRM8

DX 76, DX 76 PTR

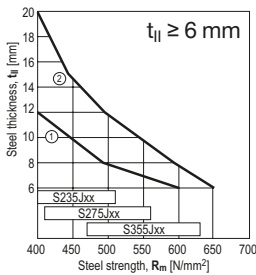

① Fastener: X-CRM8-__-12 FP10 /

Tool type: DX 76 (impact)

② Fastener: X-CRM8-__-12 FP10 /

Tool type: DX 76 (co-acting)

DX 6, DX 5, DX 460

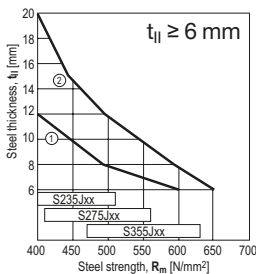

① Fastener: X-CRM8-__-12 P8 /

Tool type: DX 6, DX 5 (impact), DX 460

② Fastener: X-CRM8-__-12 P8 /

Tool type: DX 5 (co-acting), DX 460



- For co-acting operation push the fastener all the way back against the piston with a ramrod.

Application limits for X-ST-GR

Tool type: DX 76 PTR

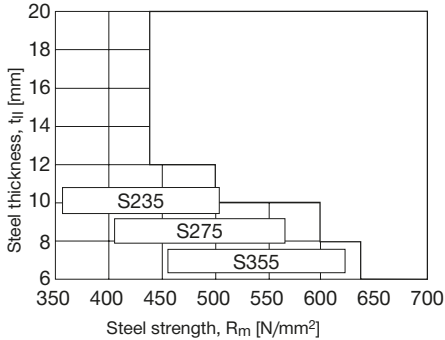

Tool type: DX 6, DX 5, DX 460

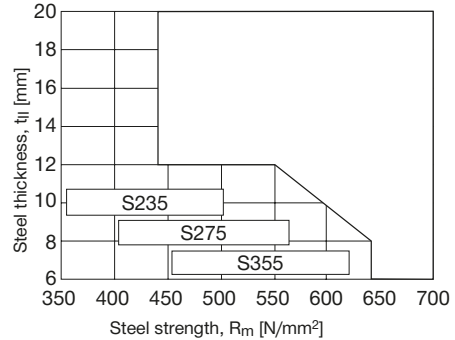

System recommendation



- For more details, please refer to the chapter **Accessories and consumables compatibility** in the Direct Fastening Technology Manual (DFTM).

Threaded studs

Designation	Fastened material thickness t_f	Tools
X-CRM8-15-12	9–13 mm	DX 6, DX 5, DX 460, DX 76, DX 76 PTR
X-CRM8-9-12	5– 8 mm	DX 6, DX 5, DX 460, DX 76, DX 76 PTR
X-ST-GR M8/10 P8	9–13 mm	DX 6, DX 5, DX 460, DX 76 PTR
X-ST-GR M8/5 P8	5– 8 mm	DX 6, DX 5, DX 460, DX 76 PTR

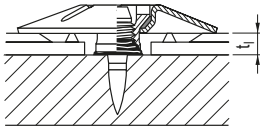

Cartridge selection and tool energy setting



- Fastener setting information (e.g. cartridge recommendation, tool power level adjustment, base material properties and fastend material properties) and installation information (e.g. quality assurance) are part of the corresponding product data sheet for fastener.
- Tool power level adjustment by setting tests on site.
- Start tool energy selection with lowest recommended tool power level.
- Correct according requirement from chapter quality assurance.

Material specification and coatings

X-FCP-R system

	① Disk	② Screw	③ Sealing ring
Material designation	X5CrNiMo17122	X2CrNiMo17132	Neoprene, black
Coating	none	none	

X-FCP-F system

	① Disk	② Screw	③ Sealing ring
Material designation	ST2K40 BK	9SMnPb28 K	Neoprene, black
Coating	Duplex	Duplex	



- Duplex: 480 h Salt spray test per DIN 50021 and 10 cycles Kesternich test per DIN 50018/2.0 (comparable to 45 µm HDG steel).

X-ST-GR

	Shank	Threaded sleeve
Material designation	P558 (CrMnMo ally)	A4 (AISI316)
Coating	none	none

X-CRM8

	Shank	Threaded sleeve
Material designation	Stainless steel wire, CR 500 (A4/AISI316)	X2CrNiMo17132 X5CrNiMo17122+2H (A4/AISI316)
Coating	none	none

Quality assurance

Fastening inspection

X-CRM8-9-12

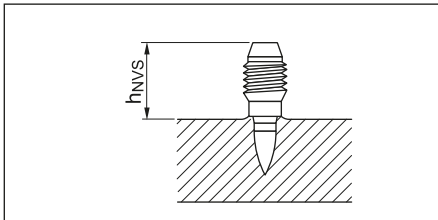

$h_{NVS} = 12.0-15.0 \text{ mm}$

X-CRM8-15-12

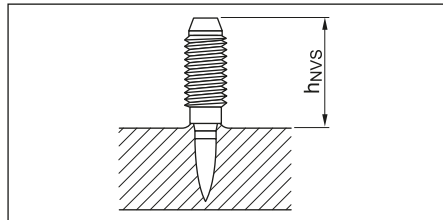

$h_{NVS} = 17.0-20.0 \text{ mm}$

X-ST-GR

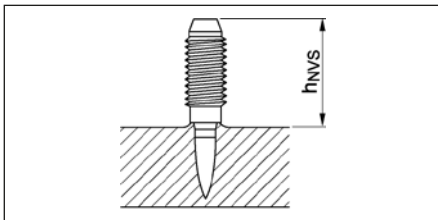

X-ST-GR M8/5 P8, $h_{NVS} = 12.0-15.0 \text{ mm}$

X-ST-GR M8/10 P8, $h_{NVS} = 17.0-20.0 \text{ mm}$

Pre-drill

Plates must be pre-drilled or pre-punched

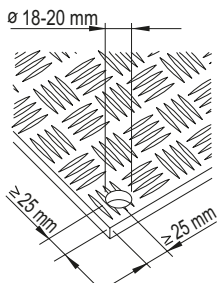

Installation recommendation

Tightening torque

	Fastener: X-ST-GR, X-CRM8
Element: X-FCP	5–8 Nm

Tightening tool recommendation for tightening with cordless screwdriver

Cordless screwdriver	Clutch type (stop detection)	Gear	Clutch
SF 2-A12	TRC	1	15
SF 2H-A12	TRC	1	15
SF 4-A22	TRC	1	8
SF 6-A22	ESC (SJ)	1	7
SF 6H-A22	ESC (SJ)	1	7



- Tool power level adjustment:

Gear:



Clutch:



- The setting of the torque via the Hilti screwdriver with torque release coupling (TRC) can change as the clutch wears over time. The specified torque setting is only a rough guide value and applies to a new Hilti screwdriver. To ensure recommended torque is applied, Hilti recommends the use of a calibrated torque wrench or the Hilti torque tool.
- The specified torque setting for the Hilti screw drivers with electronic slip clutch (ESC) is only a rough guide value as the ESC has 2 stop detections; Soft Joint (SJ) detection and Hard Joint (HJ) detection. The hard joint detection is activated due to drop in speed (fast stop) and can lead to a torque spike. The installation torque may vary depending on the user and the application. To ensure recommended torque is applied, Hilti recommends the use of a calibrated torque wrench or the Hilti torque tool.

Tightening tool recommendation for tightening with Hilti torque tool

Hilti torque tool

Torque tool S-BT 1/4" – 5 Nm

Torque tool X-BT 1/4" – 8 Nm

Fastener program

Item no. and description

Designation	Item no.	Description
X-FCP-R	308860	Checker plate
X-FCP-F	308859	Checker plate

X-IE-G 6 and X-IE-G 9 insulation fasteners

Product data

X-IE-G 6



X-IE-G 9



Product description

- Suitable for a wide range of insulation materials – Soft mineral wool, mineral wool, EPS, XPS, PIR, PUR, soft core multilayer board, rigid core multilayer board
- Suitable for 25–200 mm thick insulation
- Very high thermal efficiency in a one-step solution
- No holes in the fastener shank – helping prevent mold and moisture penetration in the insulation material
- Gauge included for easy visual control of correct fastener driving depth
- Specially-designed 90 mm disc diameter for soft mineral wool, providing excellent clamping of the insulation

Dimensions

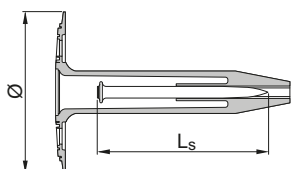

Designation	Diameter Ø	Nail length L_s	
X-IE-G 6	60 mm	36 mm	
X-IE-G 9	90 mm	36 mm	

Material properties for plastic parts

Element	Designation	Material	Color	Other properties
Plate	X-IE-G 6	HDPE	Colorless	UV stabilized material
Plate	X-IE-G 9	HDPE	Black	UV stabilized material

Material properties for carbon steel parts

Element	Designation	Material	Coating	Minimum coating thickness	Hardness
Nail	X-P 36 G3	Carbon steel	Zinc	2 µm	57.5 HRC

Approvals and certificates

Authority	Approval / certificate no.	Date of issue	Country of issue
Socotec	180668080000010	09/2018	France

 Not all information presented in this product data sheet might be subject to approval / certificate content. Please refer to approval / certificate for further information.

Applications

Curtain wall insulation

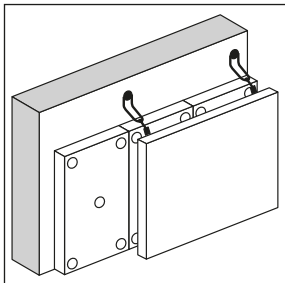

Ceiling insulation

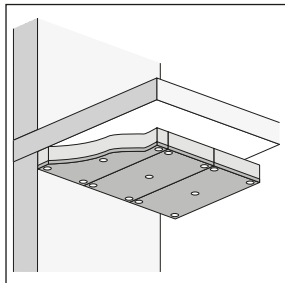

Basement perimeter insulation

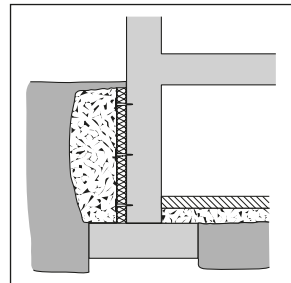

Base materials

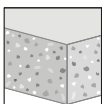

Soft concrete

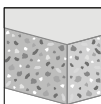

Medium concrete

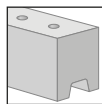

Solid sand-lime masonry

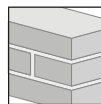

Solid brick

Fastened materials

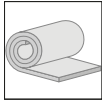

Soft mineral wool

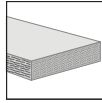

Mineral wool

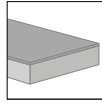

EPS

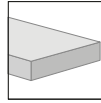

XPS

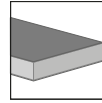

PIR, PUR

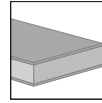

Soft and rigid core multilayer board



- Soft core multilayer board: hard top layer with insulation core of mineral wool
- Rigid core multilayer board: hard top layer with insulation core of EPS, XPS, PIR, PUR

Load condition

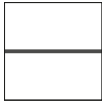

Static
quasi-static

Environmental conditions



- The intended use comprises fastening in dry conditions.
- During construction, exposure to UV due to solar radiation of the fixing element not protected by rendering shall not exceed the time of 6 weeks.
- The temperature during installation of the fixing element shall not be less than 5 °C.

Application requirements

Fastened material properties

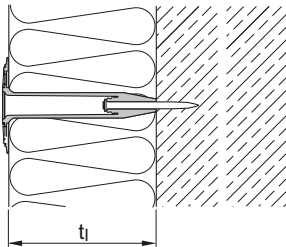

Fastened material	Compressive strength	Fastened material thickness t_f
Soft mineral wool	< 500 kN/m ²	25–200 mm
Mineral wool	< 500 kN/m ²	25–200 mm
EPS, XPS, PIR, PUR, soft core multilayer board	< 500 kN/m ²	25–200 mm
Rigid core multilayer board	< 500 kN/m ²	19–197 mm

Base material properties

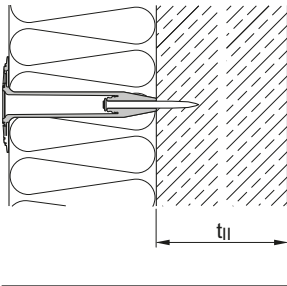

Base material	Base material strength	Base material thickness t_{II}
Soft, medium concrete	$f_{cc} = 15\text{--}45 \text{ N/mm}^2$	$\geq 80 \text{ mm}$
Tough concrete	$f_{cc} = 45\text{--}65 \text{ N/mm}^2$	$\geq 80 \text{ mm}$
Solid sand-lime masonry	$f_b = 15\text{--}45 \text{ N/mm}^2$	–
Solid brick	$f_b = 28\text{--}45 \text{ N/mm}^2$	–
Steel	$f_u = 360\text{--}450 \text{ N/mm}^2$	4–6 mm

Fastener edge distance and spacing in base material

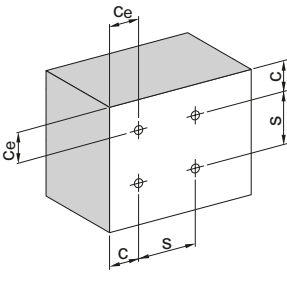

Minimum corner distance c_e	Minimum edge distance c	Minimum fastener spacing distance s
100 mm	75 mm	100 mm

Fastener edge distance and spacing in insulation material

Please consult insulation material supplier

Number of fasteners per m^2

Fastened material	Fastened material weight	Minimum number of fasteners per m^2
Soft mineral wool, mineral wool, EPS, XPS, PIR, PUR, soft core multilayer board, rigid core multilayer board	$< 50 \text{ kg/m}^2$	4
	$50\text{--}75 \text{ kg/m}^2$	5
	$> 75 \text{ kg/m}^2$	7

Fastened material	Fastened material density	Minimum number of fasteners per m^2
Soft mineral wool, mineral wool, EPS, XPS, PIR, PUR, soft core multilayer board, rigid core multilayer board	$< 10 \text{ kg/m}^3$	4
	$10\text{--}15 \text{ kg/m}^3$	5
	$> 15 \text{ kg/m}^3$	7

Performance data

Recommended resistance under tension and shear load

Base material	Tension N_{rec}	Shear V_{rec}
Soft, medium concrete	0.1 kN	0.1 kN
Solid sand-lime masonry	0.1 kN	0.1 kN
Solid brick	0.1 kN	0.1 kN

- For more details in relation to base material properties, please refer to the chapter **Fastener selection guide** in the Direct Fastening Technology Manual (DFTM).
- The above data value for solid sand-lime masonry and solid brick are based on laboratory and field experience. Because of the wide variety of types and forms of masonry in use worldwide, users are advised to carry out tests on site or on masonry of the type and form on which the fastenings are to be made.
- The above data refers to the fastener pull-out failure mode.
- For pull-over under tension load please consult insulation material supplier.

Stick rate estimation

Designation	Soft, medium concrete $15 \leq f_{c,cube} \leq 45 \text{ N/mm}^2$
X-IE-G 6, X-IE-G 9	Up to 90 %

- The stick rate indicates the percentage of nails that were driven correctly to carry a load. Stick rate can vary from the above values depending on job site conditions

Thermal efficiency according to EOTA TR 025

Application	Insulation thickness t_i	Point thermal transmittance x
Curtain wall insulation	60–90 mm	0.002 W/K
	100–200 mm	0.001 W/K
Ceiling insulation	60–90 mm	0.002 W/K
	100–200 mm	0.001 W/K
Basement perimeter insulation	60 mm	0.003 W/K
	70–100 mm	0.002 W/K
	120–200 mm	0.001 W/K

System recommendation

- For more details, please refer to the chapter **Accessories and consumables compatibility** in the Direct Fastening Technology Manual (DFTM).

Tool and energy recommendation

Designation			Tools		Gas can
			GX-IE	GX-IE XL	GC 52
X-IE-G 6	X-IE-G 6-25	X-IE-G 6-150	■	□	■
	X-IE-G 6-160	X-IE-G 6-200		■	■
X-IE-G 9	X-IE-G 9-40	X-IE-G 9-150	■	□	■
	X-IE-G 9-160	X-IE-G 9-200		■	■

■ = recommended, □ = feasible

Fastener selection

Fastened material	Insulation thickness t_i	Designation	Nail	Item number
Soft mineral wool	40 mm	X-IE-G 9-40	X-P 36 G3	2172154
	50 mm	X-IE-G 9-50	X-P 36 G3	2172155
	60 mm	X-IE-G 9-60	X-P 36 G3	2172156
	80 mm	X-IE-G 9-80	X-P 36 G3	2172157
	100 mm	X-IE-G 9-100	X-P 36 G3	2172158
	120 mm	X-IE-G 9-120	X-P 36 G3	2172159
	140 mm	X-IE-G 9-140	X-P 36 G3	2163823
	150 mm	X-IE-G 9-150	X-P 36 G3	2192919
	160 mm	X-IE-G 9-160	X-P 36 G3	2163824
	180 mm	X-IE-G 9-180	X-P 36 G3	2163825
	200 mm	X-IE-G 9-200	X-P 36 G3	2163826

Fastened material	Insulation thickness t_i	Designation	Nail	Item number
Mineral wool, EPS, XPS, PIR, PUR, soft core multilayer board	25 mm	X-IE-G 6-25	X-P 36 G3	2192914
	30 mm	X-IE-G 6-30	X-P 36 G3	2163810
	40 mm	X-IE-G 6-40	X-P 36 G3	2212514
	50 mm	X-IE-G 6-50	X-P 36 G3	2212515
	60 mm	X-IE-G 6-60	X-P 36 G3	2163813
	70 mm	X-IE-G 6-70	X-P 36 G3	2163814
	75 mm	X-IE-G 6-75	X-P 36 G3	2192915
	80 mm	X-IE-G 6-80	X-P 36 G3	2163815
	90 mm	X-IE-G 6-90	X-P 36 G3	2192916
	100 mm	X-IE-G 6-100	X-P 36 G3	2163816
	120 mm	X-IE-G 6-120	X-P 36 G3	2192917
	130 mm	X-IE-G 6-130	X-P 36 G3	2192918
	140 mm	X-IE-G 6-140	X-P 36 G3	2163817
	150 mm	X-IE-G 6-150	X-P 36 G3	2163818
	160 mm	X-IE-G 6-160	X-P 36 G3	2163819
	180 mm	X-IE-G 6-180	X-P 36 G3	2163820
200 mm	X-IE-G 6-200	X-P 36 G3	2163821	

Fastened material	Insulation thickness t_i	Designation	Nail	Item number
Rigid core multilayer board	19–22 mm	X-IE-G 6-25	X-P 36 G3	2192914
	24–27 mm	X-IE-G 6-30	X-P 36 G3	2163810
	34–37 mm	X-IE-G 6-40	X-P 36 G3	2212514
	44–47 mm	X-IE-G 6-50	X-P 36 G3	2212515
	54–57 mm	X-IE-G 6-60	X-P 36 G3	2163813
	64–67 mm	X-IE-G 6-70	X-P 36 G3	2163814
	69–72 mm	X-IE-G 6-75	X-P 36 G3	2192915
	74–77 mm	X-IE-G 6-80	X-P 36 G3	2163815
	84–87 mm	X-IE-G 6-90	X-P 36 G3	2192916
	94–97 mm	X-IE-G 6-100	X-P 36 G3	2163816
	114–117 mm	X-IE-G 6-120	X-P 36 G3	2192917
	124–127 mm	X-IE-G 6-130	X-P 36 G3	2192918
	134–137 mm	X-IE-G 6-140	X-P 36 G3	2163817
	144–147 mm	X-IE-G 6-150	X-P 36 G3	2163818
	154–157 mm	X-IE-G 6-160	X-P 36 G3	2163819
	174–177 mm	X-IE-G 6-180	X-P 36 G3	2163820
	194–197 mm	X-IE-G 6-200	X-P 36 G3	2163821



- Insulation board thickness tolerance: ± 3 mm
- Soft mineral wool, mineral wool: for intermediate thicknesses use next shorter fastener, example: for mineral wool insulation thickness 110 mm, use X-IE-G 6-100
- EPS, XPS, PIR, PUR, soft core multilayer board: for intermediate thicknesses use next longer fastener, example: for PIR insulation thickness 110 mm, use X-IE-G 6-120
- Rigid core multilayer board: for thicknesses not specified, please contact Hilti

Fastening quality assurance

Fastening inspection

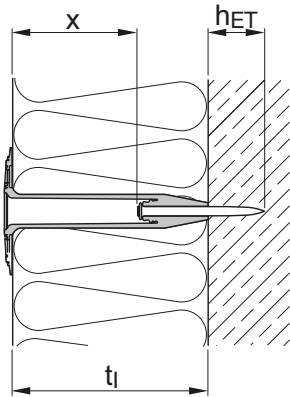

Designation	Embedment depth h_{ET}	Distance between nail head and X-IE-G plate x
X-IE-G 6-25	12-19 mm	3-10 mm
X-IE-G 6-30	12-19 mm	3-10 mm
X-IE-G 6-40, X-IE-G 9-40	12-19 mm	14-21 mm
X-IE-G 6-50, X-IE-G 9-50	12-19 mm	24-31 mm
X-IE-G 6-60, X-IE-G 9-60	12-19 mm	34-41 mm
X-IE-G 6-70	12-19 mm	44-51 mm
X-IE-G 6-75	12-19 mm	49-56 mm
X-IE-G 6-80, X-IE-G 9-80	12-19 mm	54- 61 mm
X-IE-G 6-90	12-19 mm	64-71 mm
X-IE-G 6-100, X-IE-G 9-100	12-24 mm	74-81 mm
X-IE-G 6-120, X-IE-G 9-120	12-24 mm	94-100 mm
X-IE-G 6-130	12-24 mm	104-111 mm
X-IE-G 6-140, X-IE-G 9-140	12-24 mm	114-121 mm
X-IE-G 6-150, X-IE-G 9-150	12-24 mm	124-131 mm
X-IE-G 6-160, X-IE-G 9-160	12-24 mm	134-141 mm
X-IE-G 6-180, X-IE-G 9-180	12-24 mm	154-161 mm
X-IE-G 6-200, X-IE-G 9-200	12-24 mm	174-181 mm

Setting depth control and power tool adjustment

Check setting depth with the gauge immediately after fastening

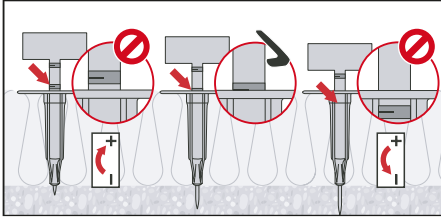

-  • Visible setting failures must be replaced with a new fastener, not in the same hole
- These are abbreviated instructions which may vary by application.
- ALWAYS review/follow the instructions accompanying the product

X-IE 6 and X-IE 9 insulation fasteners

Product data

X-IE 6



X-IE 9



Product description

- Suitable for a wide range of insulation materials – Soft mineral wool, mineral wool, EPS, XPS, PIR, PUR, soft core multilayer board, rigid core multilayer board
- Suitable for 20–200 mm thick insulation
- Very high thermal efficiency in a one-step solution
- No holes in the fastener shank – helping prevent mold and moisture penetration in the insulation material
- Gauge included for easy visual control of correct fastener driving depth
- Specially-designed 90 mm disc diameter for soft mineral wool, providing excellent clamping of the insulation

Dimensions

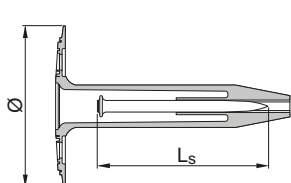

Designation	Diameter Ø	Nail length L_s	
X-IE 6	60 mm	47–62 mm	
X-IE 9	90 mm	47–62 mm	

Material properties for plastic parts

Element	Designation	Material	Color	Other properties
Plate	X-IE 6	HDPE	Colorless	UV stabilized material
Plate	X-IE 9	HDPE	Black	UV stabilized material

Material properties for carbon steel parts

Element	Designation	Material	Coating	Minimum coating thickness	Hardness
Nail	X-PX 37, X-PX 47, X-PX 52, X-PX 62	Carbon steel	Zinc	5 µm	58 HRC

Approvals and certificates

Authority	Approval / certificate no.	Date of issue	Country of issue
Socotec	1601601R0000003	07/2019	France
ITB	AT-15-7235/2015	06/2016	Poland
ITB	AT-15-7696/2016	12/2016	Poland
Russian Ministry / FCS	TS/TO 5851-19	10/2019	Russia



Not all information presented in this product data sheet might be subject to approval / certificate content. Please refer to approval / certificate for further information.

Applications

Curtain wall insulation

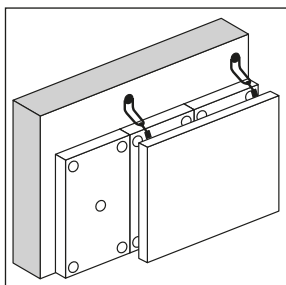

Ceiling insulation

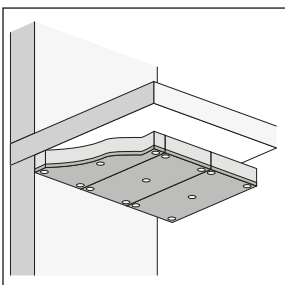

Basement perimeter insulation

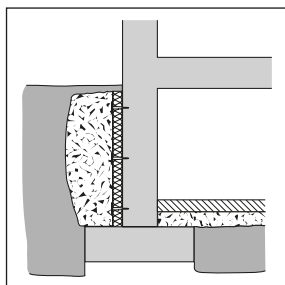

Base materials

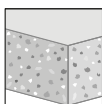

Soft concrete

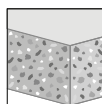

Medium concrete

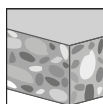

Tough concrete

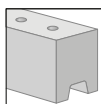

Solid sand-lime masonry



Solid brick

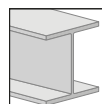

Steel

Fastened materials

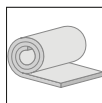

Soft mineral wool

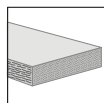

Mineral wool

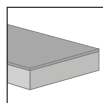

EPS

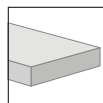

XPS

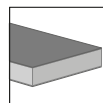

PIR, PUR

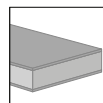

Soft and rigid core multilayer board



- Soft core multilayer board: hard top layer with insulation core of mineral wool
- Rigid core multilayer board: hard top layer with insulation core of EPS, XPS, PIR, PUR

Load condition



Static quasi-static

Environmental conditions



- The intended use comprises fastening in dry conditions.
- During construction, exposure to UV due to solar radiation of the fixing element not protected by rendering shall not exceed the time of 6 weeks.
- The temperature during installation of the fixing element shall not be less than 5 °C.

Application requirements

Fastened material properties

	Fastened material	Compressive strength	Fastened material thickness t_f
	Soft mineral wool	< 500 kN/m ²	50–200 mm
	Mineral wool	< 500 kN/m ²	20–200 mm
	EPS, XPS, PIR, PUR, soft core multilayer board	< 500 kN/m ²	20–200 mm
	Rigid core multilayer board	< 500 kN/m ²	14–197 mm

Base material properties

	Base material	Base material strength	Base material thickness t_{II}
	Soft, medium concrete	$f_{cc} = 15\text{--}45 \text{ N/mm}^2$	$\geq 80 \text{ mm}$
	Tough concrete	$f_{cc} = 45\text{--}65 \text{ N/mm}^2$	$\geq 80 \text{ mm}$
	Solid sand-lime masonry	$f_b = 15\text{--}45 \text{ N/mm}^2$	–
	Solid brick	$f_b = 28\text{--}45 \text{ N/mm}^2$	–
	Steel	$f_u = 360\text{--}450 \text{ N/mm}^2$	4–6 mm

Fastener edge distance and spacing in base material

	Minimum corner distance c_e	Minimum edge distance c	Minimum fastener spacing distance s
	100 mm	75 mm	100 mm

Fastener edge distance and spacing in insulation material

Please consult insulation material supplier

Number of fasteners per m^2

Fastened material	Fastened material weight	Minimum number of fasteners per m^2
Soft mineral wool, mineral wool, EPS, XPS, PIR, PUR, soft core multilayer board, rigid core multilayer board	$\leq 15 \text{ kg/m}^2$	4
	$> 15 \text{ kg/m}^2$	5

Fastened material	Fastened material density	Minimum number of fasteners per m^2
Soft mineral wool, mineral wool, EPS, XPS, PIR, PUR, soft core multilayer board, rigid core multilayer board	$\leq 75 \text{ kg/m}^3$	4
	$> 75 \text{ kg/m}^3$	5

Performance data

Recommended resistance under tension and shear load

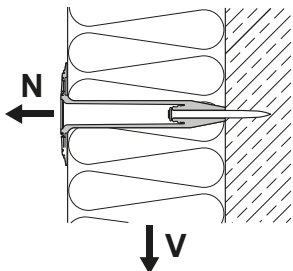

Base material	Tension N_{rec}	Shear V_{rec}
Soft, medium concrete	0.4 kN	0.4 kN
Tough concrete	0.2 kN	0.2 kN
Solid sand-lime masonry	0.2 kN	0.2 kN
Solid brick	0.2 kN	0.2 kN
Steel	0.6 kN	0.6 kN

- For more details in relation to base material properties, please refer to the chapter **Fastener selection guide** in the Direct Fastening Technology Manual (DFTM).
- The above data value for solid sand-lime masonry and solid brick are based on laboratory and field experience. Because of the wide variety of types and forms of masonry in use worldwide, users are advised to carry out tests on site or on masonry of the type and form on which the fastenings are to be made.
- The above data refers to the fastener pull-out failure mode.
- For pull-over under tension load please consult insulation material supplier.

Stick rate estimation

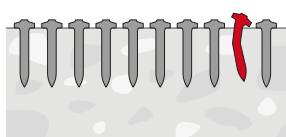

Designation	Soft, medium concrete $15 \leq f_{c,cube} \leq 45 \text{ N/mm}^2$	Tough concrete $45 < f_{c,cube} \leq 65 \text{ N/mm}^2$
X-IE 6, X-IE 9	90%–95%	85%–90%

- The stick rate indicates the percentage of nails that were driven correctly to carry a load. Stick rate can vary from the above values depending on job site conditions

Thermal efficiency according to EOTA TR 025

Application	Insulation thickness t_i	Point thermal transmittance x
Curtain wall insulation	60–90 mm	0.002 W/K
	100–200 mm	0.001 W/K
Ceiling insulation	60–90 mm	0.002 W/K
	100–200 mm	0.001 W/K
Basement perimeter insulation	60 mm	0.003 W/K
	70–100 mm	0.002 W/K
	120–200 mm	0.001 W/K

System recommendation



- For more details, please refer to the chapter **Accessories and consumables compatibility** in the Direct Fastening Technology Manual (DFTM).

Tool and energy recommendation

Designation			Tools and equipment					
			DX 6 IE		DX 5 IE		DX 460 IE	
			L equipment Fastener guide: X-6-FIE-L Piston: X-6-5-PIE-L	XL equipment Fastener guide: X-6-FIE-XL Piston: X-6-5-PIE-XL	L equipment Fastener guide: X-5-460-FIE-L Piston: X-5-460-PIE-L	XL equipment Fastener guide: X-5-460-FIE-XL Piston: X-5-460-PIE-XL	L equipment Fastener guide: X-5-460-FIE-L Piston: X-5-460-PIE-L	XL equipment Fastener guide: X-5-460-FIE-XL Piston: X-5-460-PIE-XL
X-IE 6	X-IE 6-20	X-IE 6-140	■	□	■	□	■	□
	X-IE 6-150	X-IE 6-200		■		■		■
X-IE 9	X-IE 9-50	X-IE 9-140	■	□	■	□	■	□
	X-IE 9-160	X-IE 9-200		■		■		■

■ = recommended, □ = feasible

Cartridge recommendation

Base material	Cartridge color (tool power level)	
	Tool type: DX 6 IE	Tool type: DX 5 IE, DX 460 IE
	Cartridge type: 6.8/11 M	Cartridge type: 6.8/11 M
Soft, medium concrete	titanium ■ (2-8)	yellow ■, red ■
Tough concrete	titanium ■ (2-8)	yellow ■, red ■
Solid sand-lime masonry	titanium ■ (1-5)	green ■, yellow ■
Solid brick	titanium ■ (1-5)	green ■, yellow ■
Steel	titanium ■ (2-8)	yellow ■, red ■



- Tool power level adjustment by setting tests on site.
- Start tool energy selection with lowest recommended tool power level.
- Correct according requirement from chapter quality assurance.

Fastener selection

Fastened material	Insulation thickness t_i	Designation	Nail	Item number
Soft mineral wool	50 mm	X-IE 9-50	X-PX 62	2092034
	60 mm	X-IE 9-60	X-PX 62	2041746
	80 mm	X-IE 9-80	X-PX 62	2041747
	90 mm	X-IE 9-90	X-PX 62	2041748
	100 mm	X-IE 9-100	X-PX 62	2041749
	120 mm	X-IE 9-120	X-PX 62	2041750
	140 mm	X-IE 9-140	X-PX 62	2041751
	160 mm	X-IE 9-160	X-PX 62	2041752
	180 mm	X-IE 9-180	X-PX 62	2041753
	200 mm	X-IE 9-200	X-PX 62	2041754

Fastened material	Insulation thickness t_i	Designation	Nail	Item number
Mineral wool, EPS, XPS, PIR, PUR, soft core multilayer board	20 mm	X-IE 6-20	X-PX 47	2143956
	25 mm	X-IE 6-25	X-PX 47	2041714
	30 mm	X-IE 6-30	X-PX 52	2041715
	35 mm	X-IE 6-35	X-PX 52	2041716
	40 mm	X-IE 6-40	X-PX 52	2041717
	50 mm	X-IE 6-50	X-PX 62	2041718
	60 mm	X-IE 6-60	X-PX 62	2041719
	70 mm	X-IE 6-70	X-PX 62	2041740
	75 mm	X-IE 6-75	X-PX 62	2041741
	80 mm	X-IE 6-80	X-PX 62	2041742
	90 mm	X-IE 6-90	X-PX 62	2041743
	100 mm	X-IE 6-100	X-PX 62	2041744
	120 mm	X-IE 6-120	X-PX 62	2041745
	125 mm	X-IE 6-125	X-PX 62	2323244
	140 mm	X-IE 6-140	X-PX 62	2041393
	150 mm	X-IE 6-150	X-PX 62	2048523
	160 mm	X-IE 6-160	X-PX 62	2041394
	175 mm	X-IE 6-175	X-PX 62	2323245
180 mm	X-IE 6-180	X-PX 62	2041395	
200 mm	X-IE 6-200	X-PX 62	2041396	

Fastened material	Insulation thickness t_i	Designation	Nail	Item number
Rigid core multilayer board	14–17 mm	X-IE 6-20	X-PX 37	2143956
	19–22 mm	X-IE 6-25	X-PX 47	2141714
	24–27 mm	X-IE 6-30	X-PX 52	2141715
	29–32 mm	X-IE 6-35	X-PX 52	2141716
	34–37 mm	X-IE 6-40	X-PX 52	2141717
	44–47 mm	X-IE 6-50	X-PX 62	2141718
	57–57 mm	X-IE 6-60	X-PX 62	2141719
	64–67 mm	X-IE 6-70	X-PX 62	2141740
	69–72 mm	X-IE 6-75	X-PX 62	2141741
	74–77 mm	X-IE 6-80	X-PX 62	2141742
	84–87 mm	X-IE 6-90	X-PX 62	2141743
	94–97 mm	X-IE 6-100	X-PX 62	2141744
	114–117 mm	X-IE 6-120	X-PX 62	2141745
	119–122 mm	X-IE 6-125	X-PX 62	2323244
	134–137 mm	X-IE 6-140	X-PX 62	2041393
	144–147 mm	X-IE 6-150	X-PX 62	2048523
	154–157 mm	X-IE 6-160	X-PX 62	2041394
	169–172 mm	X-IE 6-175	X-PX 62	2323245
174–177 mm	X-IE 6-180	X-PX 62	2041395	
194–197 mm	X-IE 6-200	X-PX 62	2041396	



- Insulation board thickness tolerance: ± 3 mm
- Soft mineral wool, mineral wool: for intermediate thicknesses use next shorter fastener, example: for mineral wool insulation thickness 110 mm, use X-IE 6-100
- EPS, XPS, PIR, PUR, soft core multilayer board: for intermediate thicknesses use next longer fastener, example: for PIR insulation thickness 110 mm, use X-IE 6-120
- Rigid core multilayer board: for thicknesses not specified, please contact Hilti

Quality assurance

Fastening inspection

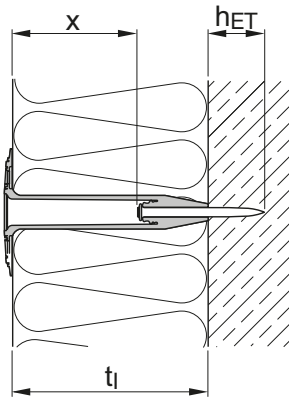

Designation	Embedment depth	Distance between nail head and X-IE plate
	h_{ET}	x
X-IE 6-20	19–24 mm	4–9 mm
X-IE 6-25	24–29 mm	4–9 mm
X-IE 6-30	24–29 mm	4–9 mm
X-IE 6-35	24–29 mm	4–9 mm
X-IE 6-40	24–29 mm	9–14 mm
X-IE 6-50, X-IE 9-50	24–29 mm	9–14 mm
X-IE 6-60, X-IE 9-60	24–29 mm	19–24 mm
X-IE 6-70	24–29 mm	29–34 mm
X-IE 6-75	24–29 mm	34–39 mm
X-IE 6-80, X-IE 9-80	24–29 mm	39–44 mm
X-IE 6-90, X-IE 9-90	24–29 mm	49–54 mm
X-IE 6-100, X-IE 9-100	24–29 mm	59–64 mm
X-IE 6-120, X-IE 9-120	24–29 mm	79–84 mm
X-IE 6-125	24–29 mm	84–89 mm
X-IE 6-140, X-IE 9-140	24–29 mm	99–104 mm
X-IE 6-150	24–29 mm	109–114 mm
X-IE 6-160, X-IE 9-160	24–29 mm	119–124 mm
X-IE 6-175	24–29 mm	134–139 mm
X-IE 6-180, X-IE 9-180	24–29 mm	139–144 mm
X-IE 6-200, X-IE 9-200	24–29 mm	159–164 mm

Setting depth control and power tool adjustment

Check setting depth with the gauge immediately after fastening

Adjust the power setting if required

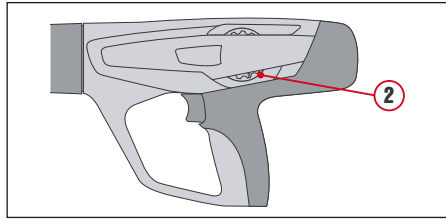
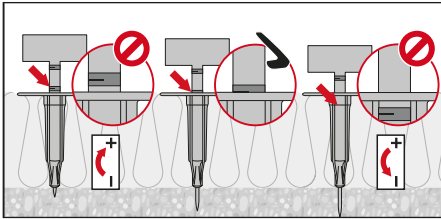

- Visible setting failures must be replaced with a new fastener, not in the same hole
- These are abbreviated instructions which may vary by application.
- ALWAYS review/follow the instructions accompanying the product

XI-FV ETICS Insulation fastener

Product data

Dimensions

XI-FV

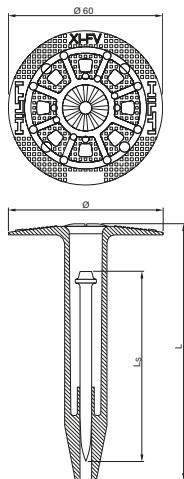

HDT-FV 90

HDT-FV 140

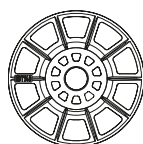

Material specifications

Plate: XI-FV – HDPE, Orange
 HDT-FV – HDPE, Orange
 Nail: Carbon steel shank: HRC 58
 Zinc coating: Delta-Tone

Recommended fastening tools

DX 6 IE, DX 6 IE XL, DX 5 IE, DX 5 IE XL, DX 460 IE, DX 460 IE XL

i • See fastener program in the next pages.

Approvals

ETA-17/0304, DOP no. Hilti-DX-DoP-006

i • Not all information presented in this product data sheet might be subject to approval/certificate content. Please refer to approval/certificate for further information.

Applications

External Thermal Insulation Composite System (ETICS)

Examples

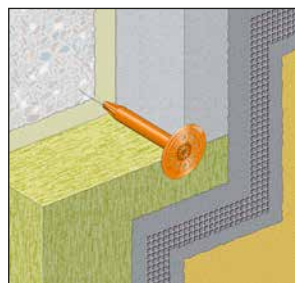

The XI-FV fastener is used to transfer wind suction loads acting on the thermal insulation composite system. The base material is normal weight concrete, which is either uncoated or coated with plaster or tiles. Coatings with plaster or tiles is often met if existing buildings are renovated and are improved with regards to their thermal insulation properties.

Performance data and application recommendation

Fixing element		XI-FV
Characteristic tension resistance in uncoated concrete fastener pull-out	$N_{Rk,p} =$	1.0 kN
Partial safety factor, fastener pull-out	$\gamma_M =$	2.0
Partial safety factor for variable action of wind suction forces	$\gamma_Q =$	1.5
Mean anchorage depth	$h_V =$	30 mm
Spacing	$s_e \geq$	100 mm
Edge distance	$c_e \geq$	75 mm
Corner distance	$c_e \geq$	100 mm
Thickness of concrete member	$h \geq$	100 mm

Characteristic resistance in concrete which is coated with plaster or tiles, see ETA-17/0304

Design value of resistance: $N_{Rd} = N_{Rk,p} / \gamma_M$

Design value of action: $N_{Sd} = N_{Sk} \cdot \gamma_Q$
 $N_{Sd} \leq N_{Rd}$

Please refer to ETA-17/0304 for detailed information on:

- the intended use (e.g. thickness of plaster and adhesive layer)
- verification of setting energy by means of control tests
- plate stiffness and point thermal transmittance

In case of concrete coated with plaster and tiles, the characteristic tension pull-out resistance needs in general be verified by job-site tests in accordance with EOTA Technical Report TR52: Recommendations for job-site tests of powder-actuated fasteners for ETICS for use in concrete.

Applicable insulation material are EPS and mineral wool.

Schematic illustration of spacings of fixing elements

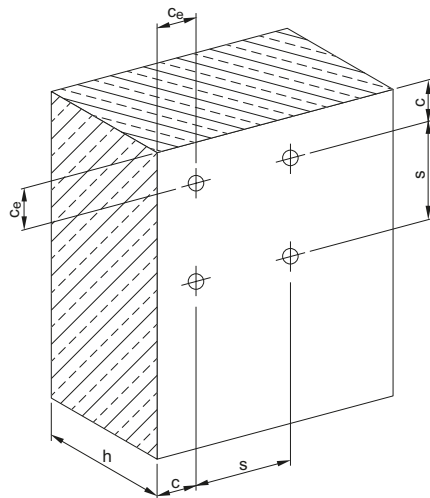

Base material

Concrete: C12/15 to C35/45

Corrosion information

The intended use comprises fastenings of thermal insulation composite systems which are subject to external atmospheric exposure.

During construction, exposure to UV due to solar radiation of the fixing element not protected by rendering shall not exceed the time of 6 weeks.

The temperature during installation of the fixing element shall not be less than 5 °C.

System recommendation

- For more details, please refer to the chapter **Accessories and consumables compatibility** in the Direct Fastening Technology Manual (DFTM).

Fastener program

Designation	Fastener	Item no.	Insulation thickness
			h_D
XI-FV 60	X-CPH 72	376484	60 mm
XI-FV 80	X-CPH 72	376485	80 mm
XI-FV 100	X-CPH 72	376489	100 mm
XI-FV 120	X-CPH 72	376490	120 mm
XI-FV 140	X-CPH 72	376491	140 mm
XI-FV 160	X-CPH 72	2069160	160 mm
XI-FV 180	X-CPH 72	2069161	180 mm
XI-FV 200	X-CPH 72	2069162	200 mm
HDT-FV 90	-	285628	-
HDT-FV 140	-	372907	-

- For soft mineral wool use XI-FV with HDT-FV 90 and HDT-FV 140.

Cartridge recommendation

Base material	Cartridge color (tool power level)	
		Tool type: DX 6 IE, DX 6 IE XL
	Cartridge type: 6.8/11 M	Cartridge type: 6.8/11 M
Soft/medium concrete	titanium ■ (2-8)	yellow ■, red ■
Tough concrete	titanium ■ (6-8)	yellow ■, red ■

- Tool power level adjustment by setting tests on site.
- Start tool energy selection with lowest recommended tool power level.
- Correct according requirement from chapter quality assurance.

Quality assurance

Cartridge colour and tool energy selection

Example in case of uncoated concrete (Annex B4 of ETA-17/0304: By means of the control tests made to uncoated concrete, the cartridge colour and tool energy required for driving in XI-FV for achieving the mean anchorage depth, h_v , is determined. Please refer to XI-FV ETA approval for more details.

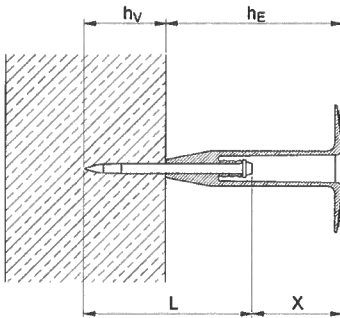

$$h_v = (\ell_N + X) - h_E = 30 \text{ mm}$$

where

h_v = mean anchorage depth

h_E = length of plastic part

L = length of powder actuated fastener

X = control dimension

Designation	Insulation thickness	Control dimension
	t_i	X
XI-FV 60	60 mm	≥ 12.5 mm
XI-FV 80	80 mm	≥ 32.5 mm
XI-FV 100	100 mm	≥ 52.5 mm
XI-FV 120	120 mm	≥ 72.5 mm
XI-FV 140	140 mm	≥ 92.5 mm
XI-FV 160	160 mm	≥ 112.5 mm
XI-FV 180	180 mm	≥ 132.5 mm
XI-FV 200	200 mm	≥ 152.5 mm

These are abbreviated instructions which may vary by application.

ALWAYS review/follow the instructions accompanying the product.

X-SW Soft washer

Product data

Product description

X-SW 30 MX X-SW 30-C



X-SW 60 MX X-SW 60-C



- Bearing surface engineered for better clamping of thin membranes
- Helps to prevent tearing or ripping of thin or soft membranes
- Soft washer conforms to uneven surfaces
- 30 mm soft washer – suitable for fastening fabric waterproofing membranes to concrete surfaces
- 60 mm soft washer – provides large bearing surface for superior clamping of thin and delicate membranes

Dimensions for plastic elements

Technical drawing	Designation	Diameter d	Height h
	X-SW 30 MX, X-SW 30-C 37	36 mm	13.8 mm
	X-SW 60 MX, X-SW 60-C 37	68 mm	15 mm

Dimensions

Technical drawing	Designation	Shank length L_s	Head length L_h	Shank diameter d_s	Head diameter d_h
	X-C 37	37 mm	2 mm	3.5 mm	8 mm



• Info for single nails are part the corresponding Product Data Sheets.

Material specification and material properties for plastic elements

Designation	Elements	Material	Color	Others
X-SW 30 MX	Soft washer	PE	Light grey, RAL 7035	
X-SW 60 MX	Soft washer	PE	Light grey, RAL 7035	

Material specification and material properties for steel elements

Designation	Elements	Material	Coating	Minimum coating thickness	Hardness
X-C 37	Nail	Carbon steel	Zinc	5 µm	56.5 HRC



• Info for single nails are part of the corresponding Product Data Sheets.

Approvals and certificates

Authority	Approval / certificate no.	Date of issue	Country of issue
ITB	AT-15-7696/2016	12/2016	Poland
Rom. Ministry, ICECON	AT 016-01_420-2020	03/2020	Romania



Not all information presented in this product data sheet might be subject to approval / certificate content. Please refer to approval / certificate for further information.

Applications

Drainage membrane

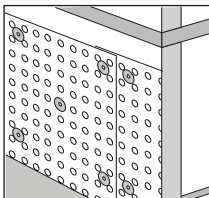

Insulation

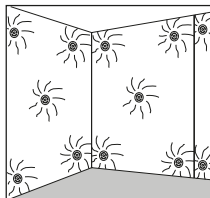

Nets, fabric and similar

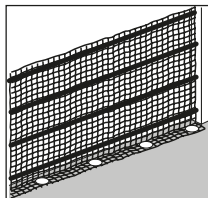

Plastic sheets

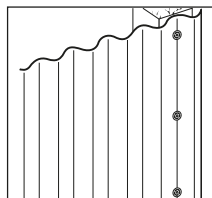

Base materials

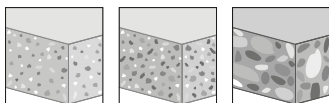

Soft concrete

Medium concrete

Tough concrete

Load conditions



Static/
quasi static

Environmental conditions



Dry indoor

- The intended use comprises fastening in dry conditions or temporary outdoor conditions.
- For more details, please refer to following technical document: Hilti Corrosion Handbook.

Fastener program

Item no. and description

Designation	Item no.	Description
X-SW 30 MX	371370	Soft washer
X-SW 60 MX	371371	
X-SW 30-C 37	40614	Soft washer with pre-mounted nail
X-SW 30-C 47	40615	
X-SW 30-C 62	40616	
X-SW 60-C 37	40643	
X-SW 60-C 47	40644	
X-SW 60-C 62	40645	

X-SW Soft washer – Fastening drainage membrane to concrete

Application recommendation

Fastened material properties

	Fastened material	Drainage membrane
	Fastened material thickness t_1	2–10 mm

Fastener positioning in fastened material

- Please consult drainage membrane supplier for data with regard to fastener edge distance, spacing and minimum number of fasteners per m^2 .

Base material properties and fastener positioning in base material

	Base material	Concrete
	Base material thickness h_{min}	80 mm
	Edge distance $c_{1,min}, c_{2,min}$	70 mm
	Fastener spacing $s_{1,min}, s_{2,min}$	100 mm

- For more details in relation to base material properties, please refer to the chapter **Fastener selection guide** in the Direct Fastening Technology Manual (DFTM).

Fastener shank length recommendation

	For standard fastening:	$L_s = h_{ET} + t_1$
--	-------------------------	----------------------

Performance data



- Temporary application, no load data required.

Stick rate estimation

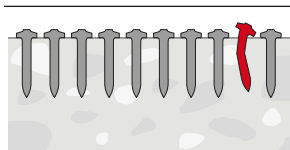

Designation	Soft/medium concrete	Tough concrete
X-SW MX + X-X 27 MX	-	70-80 %
X-SW MX + X-C MX	-	-
X-SW MX + X-GN MX	-	-



- The stick rate indicates the percentage of nails that were driven correctly to carry a load.
- Stick rate can vary from the above values depending on job site conditions.

System recommendation



- For more details, please refer to the chapter **Accessories and consumables compatibility** in the Direct Fastening Technology Manual (DFTM).

Recommendation for fastening collated nails with powder-actuated tool

Designation	Powder-actuated tool			Base material		
	DX 6 MX	DX 5 MX	DX 460 MX	Soft concrete	Medium concrete	Tough concrete
X-SW 30, 60 MX + X-X 27 MX	■	■	□	■	■	■
X-SW 30, 60 MX + X-C 27 to 37 MX	■	■	□	■	■	

■ = recommended □ = feasible

Recommendation for fastening single nails with powder-actuated tool

Designation	Powder-actuated tool				Base material			
	DX 6 F8	DX 5 F8	DX 460 F8	DX 2	Soft concrete	Medium concrete	Tough concrete	
X-SW 30, 60 MX + X-X 27 P8	■	■	□		■	■	■	
X-SW 30, 60 MX + X-C 37 P8	■	■	□	■	■	■	□	
X-SW 30-C 37, X-SW 60-C 37	■	■	□	■	■	■		

■ = recommended □ = feasible

Cartridge recommendation

Base material	Cartridge color (tool power level)	
	Tool type: DX 6 MX DX 6 F8 Cartridge type: 6.8/11 M	Tool type: DX 5 MX, DX 460 MX DX 5 F8, DX 460 F8, DX 2 Cartridge type: 6.8/11 M
Soft/medium concrete	titanium ■ (2-4)	yellow ■, red ■
Tough concrete	titanium ■ (2-6)	yellow ■, red ■

Recommendation for fastening collated nails with gas-actuated tool

Designation	Gas-actuated tool				Base material			
	GX 120-ME	GX 2	GX 3		Soft concrete	Medium concrete		
X-SW 30, 60 + X-GN 39 MX	☐				■	■		
X-SW 30, 60 + X-C 39 G2 MX		■			■	■		
X-SW 30, 60 + X-C 39 G3 MX			■		■	■		

■ = recommended ☐ = feasible

- Tool power level adjustment by setting tests on site.
- Start tool energy selection with lowest recommended tool power level.
- Correct according requirement from chapter quality assurance.

Quality assurance

Setting depth control

	Fastener stand-off h_{NVS}	7-11 mm
--	------------------------------	---------

- Visible setting failures must be replaced with a new fastener, not in the same hole.
- These are abbreviated instructions which may vary by application.
- Always review /follow the instructions accompanying the product.

X-SW Soft washer – Fastening insulation to concrete

Application recommendation

Fastened material properties

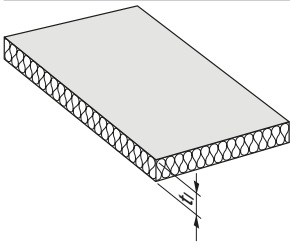

Fastened material	Insulation
Fastened material thickness t_i	2–30 mm

- Please consult insulation supplier for data with regard to fastener edge distance, spacing and minimum number of fasteners per m^2 .

Base material properties and fastener positioning in base material

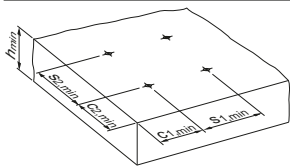

Base material	Concrete
Base material thickness h_{min}	80 mm
Edge distance $C_{1,min}$, $C_{2,min}$	70 mm
Fastener spacing $S_{1,min}$, $S_{2,min}$	100 mm

Base material properties

- For more details, please refer to the chapter **Fastener selection guide** in the Direct Fastening Technology Manual (DFTM).

Fastener shank length recommendation

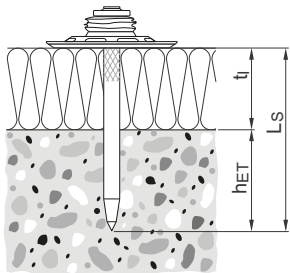



For standard fastening:

$$L_s = h_{ET} + t_i$$

Performance data

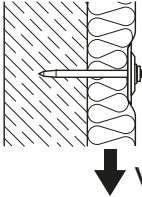
Recommended resistance under tension and shear load

Designation	Tension load N_{rec}		Shear load V_{rec}	
	Soft/medium concrete		Soft/medium concrete	
X-SW + X-C	0.30 kN		0.30 kN	
X-SW 30-C	0.30 kN		0.30 kN	
X-SW 60-C	0.30 kN		0.30 kN	

-  • Redundancy of fastening points is required.
- Minimum number of fastening points for safety relevant fastenings: ≥ 5 .
- Predominantly static loading.
- Design loads valid for nail pull-out strength.
- Fastened material has to be considered separately.
- Valid for concrete C 30/37.
- For more details in relation to base material properties, please refer to the chapter **Fastener selection guide** in the Direct Fastening Manual (DFTM).

Stick rate estimation

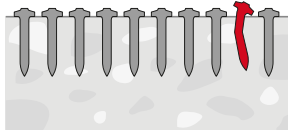
	Designation	Soft/medium concrete	Tough concrete
	X-SW + X-C	-	-
X-SW 30-C	-	-	
X-SW 60-C	-	-	

-  • The stick rate indicates the percentage of nails that were driven correctly to carry a load.
- Stick rate can vary from the above values depending on job site conditions.

System recommendation



- For more details, please refer to the chapter **Accessories and consumables compatibility** in the Direct Fastening Technology Manual (DFTM).

System recommendation for fastening collated nails with powder-actuated tool

Designation	Powder-actuated tool				Base material			
	DX 6 MX	DX 5 MX	DX 460 MX		Soft concrete	Medium concrete		
X-SW 30 + X-C 37 MX	■	■	□		■	■		
X-SW 60 + X-C 37 MX	■	■	□		■	■		

■ = recommended □ = feasible

System recommendation for fastening single nails with powder-actuated tools

Designation	Powder-actuated tool				Base material			
	DX 6 F8	DX 5 F8	DX 460 F8	DX 2	Soft concrete	Medium concrete		
X-SW 30 MX + X-C 37 F8	■	■	□	□	■	■		
X-SW 60 MX + X-C 37 F8	■	■	□	□	■	■		
X-SW 30-C 37	■	■	□	□	■	■		
X-SW 30-C 47	■	■	□	□	■	■		
X-SW 30-C 62	■	■	□	□	■	■		
X-SW 60-C 37	■	■	□	□	■	■		
X-SW 60-C 47	■	■	□	□	■	■		
X-SW 60-C 62	■	■	□	□	■	■		

■ = recommended □ = feasible

Cartridge recommendation

Base material	Cartridge color (tool power level)	
	Tool type: DX 6 MX DX 6 F8	Tool type: DX 5 MX, DX 460 MX DX 5 F8, DX 460 F8, DX 2
	Cartridge type: 6.8/11 M	Cartridge type: 6.8/11 M
Soft/medium concrete	titanium ■ (2-6)	yellow ■, red ■
Tough concrete	titanium ■ (2-6)	yellow ■, red ■



- Tool power level adjustment by setting tests on site.
- Start tool energy selection with lowest recommended tool power level.
- Correct according requirement from chapter quality assurance.

Quality assurance

Setting depth control

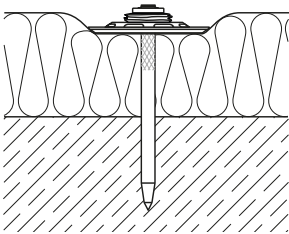

- Visible setting failures must be replaced with a new fastener, not in the same hole.
- These are abbreviated instructions which may vary by application.
- Always review /follow the instructions accompanying the product.

X-FS Form stop

Product data

Product description

X-FS MX



X-FS C 52



- Facilitates quick and easy positioning of formwork panels on concrete
- Designed for extremely high productivity – up to five times faster than traditional methods
- Easy to install even on rough concrete surfaces
- Stronger bond with the concrete due to large openings
- Formwork spacers remain hardly visible or fully hidden in concrete after removing formwork

Dimensions for plastic elements

Technical drawing	Designation	Diameter d	Height h
	X-FS MX	50 mm	35.2 mm
	X-FS C 52	50 mm	35.2 mm

Dimensions for nails

Technical drawing	Designation	Shank length L_s	Head length L_h	Shank diameter d_s	Head diameter d_h
	X-C 52	52 mm	2 mm	3.5 mm	8 mm

Material specification and material properties for plastic elements

Designation	Elements	Material	Color	Others
X-FS MX	Form stop	HDPE	Light grey, RAL 7035	
X-FS C 52	Form stop	HDPE	Light grey, RAL 7035	

Material specification and material properties for steel elements

Designation	Elements	Material	Coating	Minimum coating thickness	Hardness
X-C 52	Nail	Carbon steel	Zinc	5 µm	56.5 HRC

- Info for single nails are part of the corresponding Product Data Sheets.

Approvals and certificates

Authority	Approval / certificate no.	Date of issue	Country of issue
ITB	AT-15-7696/2016	12/2016	Poland
Rom. Ministry, ICECON	AT 016-01_420-2020	03/2020	Romania

- Not all information presented in this product data sheet might be subject to approval / certificate content. Please refer to approval / certificate for further information.

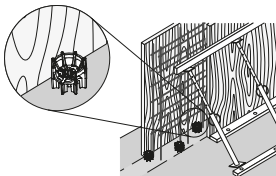
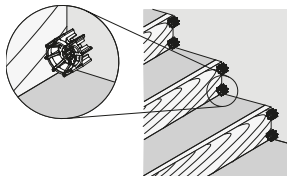
Applications
Formwork to concrete

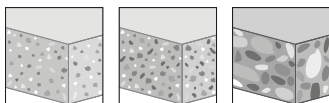
Minor formwork to concrete

Base materials

 Soft
concrete

 Medium
concrete

 Tough
concrete

Load conditions

 Static/
quasi static

Environmental conditions

Dry indoor



- The intended use comprises fastening in dry conditions or temporary outdoor conditions.
- For more details, please refer to following technical document: Hilti Corrosion Handbook.

Fastener program
Item no. and description

Designation	Item no.	Description
X-FS MX	408022	Form stop
X-FS C 52	407346	Form stop with pre-mounted nail

X-FS Form stop – Fastening formwork

Application recommendation

Fastened material properties and fastener positioning in fastened material

	Base material	Concrete
	Base material thickness h_{min}	80 mm
	Edge distance $c_{1,min}, c_{2,mi}$	70 mm
	Fastener spacing $s_{1,min}, s_{2,min}$	100 mm

Performance data

Recommended resistance under shear load

Designation	Shear load V_{rec}	
	Soft/medium concrete	Tough concrete
X-FS MX + X-X 52 MX	0.50 kN	0.50 kN
X-FS MX + X-C 52 MX	0.40 kN	–
X-FS MX + X-X 52 P8	0.50 kN	0.50 kN (DX 2: 0.20 kN)
X-FS C 52 pre-mounted	0.40 kN	–

- Redundancy of fastening points is required.
- Minimum number of fastening points for safety relevant fastenings: ≥ 5 .
- For more details, please refer to the chapter **Fastener selection guide** in the Direct Fastening Technology Manual (DFTM).

Stick rate estimation

	Designation	Soft/medium concrete	Tough concrete
	X-FS MX + X-X 52 MX	90–95 %	85–95 %
	X-FS MX + X-C 52 MX	–	–
	X-FS MX + X-X 52 P8	90–95 %	85–95 %
	X-FS C 52	–	–

- The stick rate indicates the percentage of nails that were driven correctly to carry a load.
- Stick rate can vary from the above values depending on job site conditions.

System recommendation

- For more details, please refer to the chapter **Accessories and consumables compatibility** in the Direct Fastening Technology Manual (DFTM).

System recommendation for fastening collated nails with powder-actuated tool

Designation	Powder-actuated tool			Base material			
	DX 6 MX	DX 5 MX	DX 460 MX	Soft concrete	Medium concrete	Tough concrete	
X-FS MX + X-X 52 MX	■	■	□	■	■	■	
X-FS MX + X-C 52 MX	■	■	□	■	■		

■ = recommended □ = feasible

System recommendation for fastening single nails with powder-actuated tools

Designation	Powder-actuated tool				Base material		
	DX 6 F8	DX 5 F8	DX 460 F8	DX 2	Soft concrete	Medium concrete	Tough concrete
X-FS MX + X-X 52 P8	■	■	□		■	■	■
X-FS MX + X-X 52 P8				■	■	■	□
X-FS C 52	■	■	□	■	■	■	

■ = recommended □ = feasible

Cartridge recommendation

Base material	Cartridge color (tool power level)	
	Tool type: DX 6 MX DX 6 F8	Tool type: DX 5 MX, DX 460 MX DX 5 F8, DX 460 F8, DX 2
	Cartridge type: 6.8/11 M	Cartridge type: 6.8/11 M
Soft/medium concrete	titanium ■ (2-6)	yellow ■, red ■
Tough concrete	titanium ■ (6-8)	yellow ■, red ■

- Tool power level adjustment by setting tests on site.
- Start tool energy selection with lowest recommended tool power level.
- Correct according requirement from chapter quality assurance.

Quality assurance

Setting depth control

	Fastener stand-off h_{NVS}	22–32 mm
--	------------------------------	----------

- Visible setting failures must be replaced with a new fastener, not in the same hole.
- These are abbreviated instructions which may vary by application.
- Always review/follow the instructions accompanying the product.

X-DFS Double form stop

Product data

Dimensions

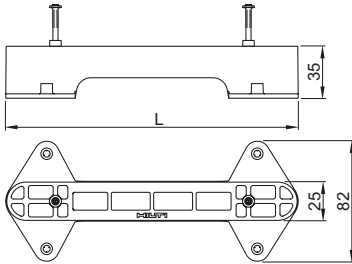

Material specifications

X-DFS: polypropylene
(halogen and silicone free)
grey (RAL 7030),
green (RAL 6018),
light brown (RAL 8001)

Nails (pre-mounted):

X-C 62: Carbon steel, HRC 56.5,
 $d_{nom} = 3.5 \text{ mm}$,
zinc coating 5–20 μm

Recommended fastening tools

DX 6 F8, DX 5 F8, DX 460 F8,
DX 351 ME, DX 2



- See fastener program in the next pages.

Material specification and material properties for carbon steel elements

Nail recommendation for concrete base material

Nail type	Length	Tip	Shank \varnothing	Material	Hardness	Coating
X-C 62	62 mm	Cut	3.5 mm	Carbon steel	56.5 HRC	Zinc, 5–20 μm



- Two X-C 62 nails are pre-mounted to each X-DFS element.

Applications

Example

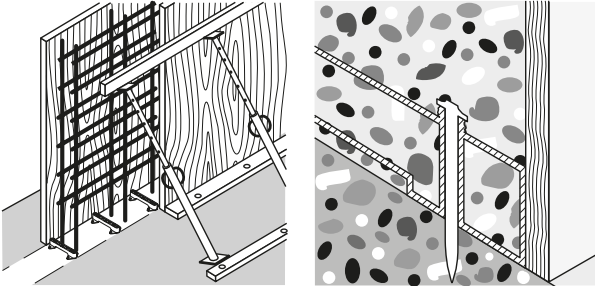

- Positioning concrete forms on concrete surfaces.
- Leave in place formwork spacer, polypropylene is non rusting, nearly invisible and non-conductive.
- Fixed-length form stops for soft concrete base material.

Performance data

Recommended resistance under shear load

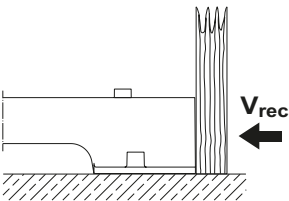

Shear load: $V_{rec} = 0.4 \text{ kN}$

- Predominantly static, however, vibration from concrete compacting is allowed.
- Valid for soft concrete, medium concrete with strength of $f_{C, \text{cube}} = 25\text{-}45 \text{ N/mm}^2$.
- For more details in relation to base material properties, please refer to the chapter **Fastener selection guide** in the Direct Fastening Technology Manual (DFTM).

Application recommendation

Base material thickness

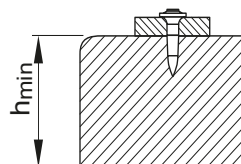

Concrete: $h_{min} = 80 \text{ mm}$

Fastener positioning in base material

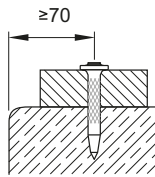
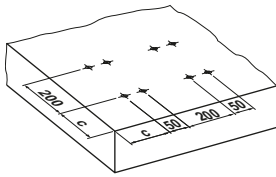

Edge distance: $c \geq 70$ mm

Corrosion information

- For temporary fixations no restrictions exist.
- For more details, please refer to following technical document:
Hilti Corrosion Handbook.

System recommendation

- For more details, please refer to the chapter **Accessories and consumables compatibility** in the Direct Fastening Technology Manual (DFTM).

Cartridge recommendation

Base material	Cartridge color (tool power level)	
	Tool type: DX 6 F8	Tool type: DX 5 F8, DX 460 F8, DX 351 ME, DX 2
	Cartridge type: 6.8/11 M	Cartridge type: 6.8/11 M
Soft/medium concrete	titanium ■ (1-5)	green ■, yellow ■, red ■
Tough concrete	titanium ■ (4-8)	yellow ■, red ■

- Tool power level adjustment by setting tests on site.
- Start tool energy selection with lowest recommended tool power level.
- Correct according requirement from chapter quality assurance.

Fastener program

Designation	Item no.	Length L	Nail shank d_{nom}
X-DFS 160 C62	2159751	160 mm	3.5 mm
X-DFS 180 C62	2159752	180 mm	3.5 mm
X-DFS 200 C62	2159753	200 mm	3.5 mm

X-EGN, X-GHP, X-GN Fastener for gas-actuated tool

Product data

Dimensions

X-EGN 14

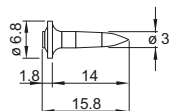

X-GHP 17/20/24

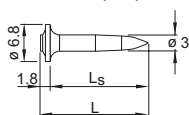

X-GN 20/27/32

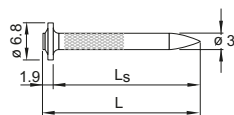

X-GN 39

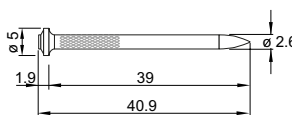

Material specifications

Carbon steel shank:	X-EGN	HRC 57.5
	X-GHP	HRC 57.5
	X-GN	HRC 56.5
Zinc coating:	2–13 µm	

Recommended fastening tools

GX 120, GX 120-ME
GX 100, GX 100 E

- For more details, please refer to **X-EGN, X-GHP, X-GN fastener program** and to the chapter **Accessories and consumables compatibility** in the Direct Fastening Technology Manual (DFTM).

Approvals

ICC-ESR 1752 (USA):	X-GN 20/27/32, X-EGN 14, X-GHP 16/17/20/24
IBMB	X-GHP, X-GN

- Not all information presented in this product data sheet might be subject to approval / certificate content. Please refer to approval / certificate for further information.

Applications

Examples

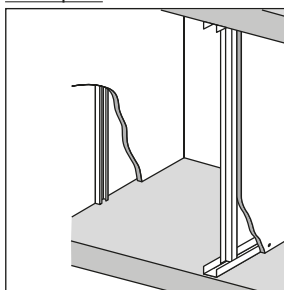

Drywall tracks to concrete and steel



Electrical applications

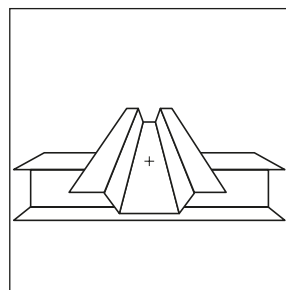

Temporary tacking of composite deck to steel beams

Performance data

Recommended resistance under tension and shear load for drywall track fastening

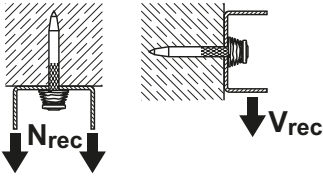
X-EGN (Base material: steel)

Tension N_{rec}	Shear V_{rec}
0.4 kN	0.4 kN

X-GHP, X-GN (Base material: concrete / sand-lime masonry)

Embedment	Tension N_{rec}		Shear V_{rec}		Tension N_{rec}	Shear V_{rec}
	Concrete Type					
	Soft/ medium	Tough	Soft/ medium	Tough	Sand-lime masonry	
≥ 22 mm	-	-	-	-	0.3 kN	0.3 kN
≥ 18 mm	0.2 kN	-	0.2 kN	-	0.2 kN	0.2 kN
≥ 14 mm	0.1 kN	0.1 kN	0.1 kN	0.1 kN	0.1 kN	0.1 kN

Conditions

- For safety relevant fastenings sufficient redundancy of the entire system is required; Minimum of 5 nails per fastened track. All visible setting failures must be replaced
- Sheet metal failure is not considered in recommended loads and must be assessed separately
- Soft, medium concrete up to $f_{c,cube} = 45 \text{ N/mm}^2$ (C35/45), some tough concrete up to $f_{c,cube} = 60 \text{ N/mm}^2$ (C50/60).
- Concrete with aggregate like granite or river rock or softer, and up to 16 mm diameter

Stick rate estimation

Designation	Soft/medium concrete	Tough concrete
X-GHP	85–98%	70–85%
X-GN	75–90%	55–70%



- The stick rate indicates the percentage of nails that were driven correctly to carry a load.
- Stick rate can vary from the above values depending on job site conditions.

X-EGN 14 MX for temporary tacking of composite decks

Tension N_{rec}	Shear V_{rec}
0.4 kN	0.4 kN

Conditions

- The intended use of the fastenings is to secure the deck position and to ensure a safe working platform during the erection state only. The fasteners serve as temporary fixation until the shear connectors of the composite beams are attached.
- At each permanent composite deck support, it is recommended to drive at least one fastener per trough.
- Every deck panel must be fixed at least with two fasteners at every permanent support.
- Single layer sheet with a maximum thickness of 1.25 mm.
- Sheeting grade up to S450 acc. to EN 10346.
- Minimum base material thickness: 6 mm.
- Minimum steel grade: S235 acc. to EN 10025-2.

Application recommendation

Thickness of base material

Concrete

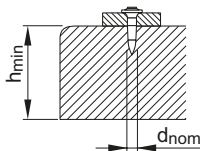

$$h_{min} = 60 \text{ mm}$$

$$(d_{nom} = 3.0 \text{ mm})$$

Steel

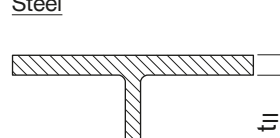

$$t_{II} \geq 4 \text{ mm}$$

Thickness of fastened material

- Wooden track: $t_1 \leq 25 \text{ mm}$
 Metal track: $t_1 \leq 2 \text{ mm}$

Spacing and edge distances (mm)

Spacing along track
(as per U.S. Gypsum Handbook)

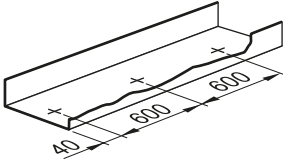

All track ends (cut-outs for doors),
secure with 2 nails

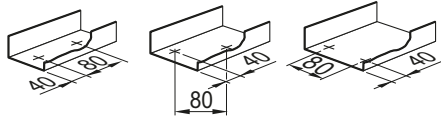

Distance to edge of concrete / Fastener spacings on wood:
sandlime masonry

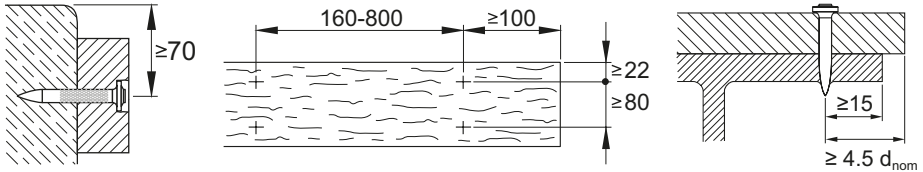

Application limits

X-EGN 14

For fastening on steel

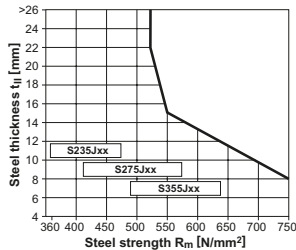

For temporary tacking of composite decks

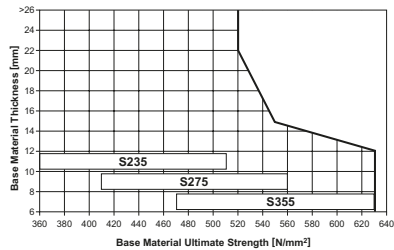

Design conditions:

- Single layer sheet with a maximum thickness of 1.25 mm.
- Sheeting grade up to S450 acc. to EN 10346.
- Minimum base material thickness: 6 mm
- Minimum steel grade: S235 acc. to EN 10025-2

Corrosion information

- The intended use only comprises fastenings which are not directly exposed to external weather conditions or moist atmospheres.
- For more details, please refer to following technical document: Hilti Corrosion Handbook.

Fastener program and system recommendation
Fastener program for fastening to concrete/sandlime masonry

Designation	Application	Base material	
X-GN 39 MX	Wooden track ($t_1 \leq 25$ mm)	Concrete/sandlime masonry	Increasing strength
X-GN 27MX	Metal track	Concrete/sandlime masonry	
X-GN 20 MX	Metal track	Concrete/sandlime masonry	
X-GHP_MX	Metal track	Concrete/sandlime masonry	

Fastener programm for fastening to steel

Designation	Application	Base material	
X-EGN 14	Metal track	Steel	

Item numbers and technical information

Designation	Item no.	L_s	L	d_{nom}
X-EGN 14 MX	340231	14 mm	15.8 mm	3.0 mm
X-GHP 16 MX	2071471	16 mm	17.8 mm	3.0 mm
X-GHP 17 MX	340228	18 mm	19.8 mm	3.0 mm
X-GHP 20 MX	285724	20 mm	21.8 mm	3.0 mm
X-GHP 24 MX	438945	24 mm	25.8 mm	3.0 mm
X-GN 20 MX	340232	19 mm	20.9 mm	3.0 mm
X-GN 27 MX	340230	27 mm	28.9 mm	3.0 mm
X-GN 32 MX	340233	32 mm	33.9 mm	3.0 mm
X-GN 39 MX	340234	39 mm	40.9 mm	2.6 mm

Tool and gas can

Tool designation	Gas can
GX 120 / GX 120 ME	GC 20, GC 21 and GC 22
GX 100 / GX 100 E	GC 11 and GC 12 (for USA)

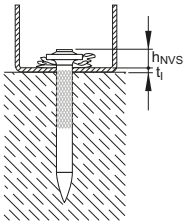
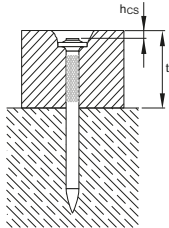
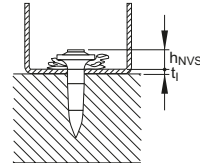
Quality assurance**Fastening inspection**Fastening to concrete / sandlime masonryX-GN/GHP: $h_{NVS} = 2-5$ mmX-GN 39: $h_{CS} = 2-3$ mmFastening to steelX-EGN 14: $h_{NVS} = 2-9$ mm

GX 3 System Fastener for interior finishing, building construction, mechanical and electrical application

Product data

GX 3 gas tool



GX 3, GX 3-ME

Nails for fastening to concrete

X-P 17/20/24 G3 MX

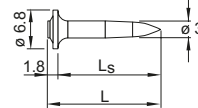

X-C 20/27/32 G3 MX

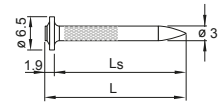

X-C 39 G3 MX

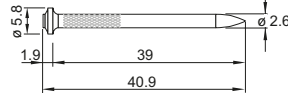

Nails for fastening to steel

X-S 14 G3 MX

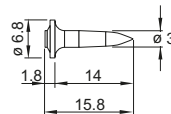

Material specification for nails

X-P G3 MX, X-S G3 MX

Carbon steel, HRC 57.5, 2-13 μm zinc coating

X-C G3 MX

Carbon steel, HRC 56.5, 2-13 μm zinc coating

Approvals and certificates

ICC-ESR 1752 (USA)

X-P 17/20/24 G3 MX, X-C 20/27/32 G3 MX and X-S 14 G3 MX

IBMB

X-P 17/20/24 G3 MX, X-C 20/27/32/39 G3 MX

ETA-16/0301

X-P 20/24 G3 MX



- Not all information presented in this product data sheet might be subject to approval/certificate content. Please refer to approval/certificate for further information.

Applications

Examples



Drywall tracks



Light-duty building construction applications

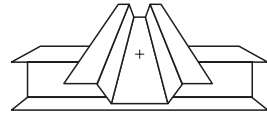

Temporary tacking of composite deck to steel beams

Product data

Electrical elements to be used with nails

X-ECT MX



X-UCT MX



X-EKS MX

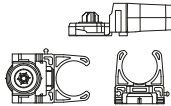

X-EKSC MX

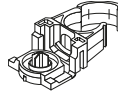

X-FB MX

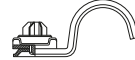

X-ECH MX



X-DFB MX



X-EKB MX



X-ECC MX



X-EHS MX



X-ET MX

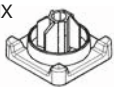

X-TT



X-ECT 40 MX



Material specifications for plastic parts

X-ECT MX, X-EKS, X-EKSC MX, ECH MX	PA, halogen free, silicone free, light grey RAL 7035
X-EKB MX	PA, halogen free, light grey RAL 7035
X-ECT-FR MX	PBT, silicone free, flame retardant, stone grey RAL 7030
X-EKB-FR MX	PBT, silicone free, flame retardant, stone grey RAL 7030
X-UCT MX, X-ET MX	HDPE, halogen free, silicone free, light grey RAL 7035
X-TT	PET
X-FB MX, X-DFB MX	Galvanized steel sheet $f_u = 270-420 \text{ N/mm}^2$, 10-20 μm zinc coating
X-ECC MX, X-EHS MX	Galvanized steel sheet $f_u = 270-420 \text{ N/mm}^2$, 10-20 μm zinc coating

Approvals and certificates

ICC-ESR 1752 (USA), IBMB, ETA-16/0301

Applications



Conduits and light-duty pipes



Electrical cables

Product data

GX 3 gas tool



GX 3, GX 3-ME

Studs for fastening to concrete

X-M6-7-24 G3 P7

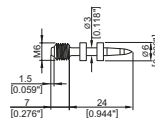

X-W6-12-20 G3 P7

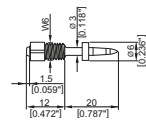

Studs for fastening to steel

X-M6-7-14 G3 P7

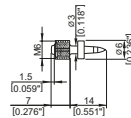

X-W6-12-14 G3 P7

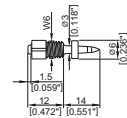

Material specifications for studs

Carbon steel shank

HRC 57.5

Zinc coating

2-10 µm

Applications



Junction boxes, switch boxes, etc.



Pipe rings for light-duty pipes

Performance data

Recommended resistance under tension and shear load for drywall track fastening

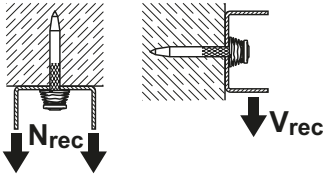

X-S 14 G3 MX (Base material: steel)

Tension N_{rec}	Shear V_{rec}
0.4 kN	0.4 kN

X-P G3, X-C G3 (Base material: concrete / sand-lime masonry)

Embedment	Tension N_{rec}		Shear V_{rec}		Tension N_{rec}	Shear V_{rec}
	Concrete Type					
	Soft/ medium	Tough	Soft/ medium	Tough		
					Sand-lime masonry	
≥ 22 mm	-	-	-	-	0.3 kN	0.3 kN
≥ 18 mm	0.2 kN	-	0.2 kN	-	0.2 kN	0.2 kN
≥ 14 mm	0.1 kN	0.1 kN	0.1 kN	0.1 kN	0.1 kN	0.1 kN

Conditions

- For safety relevant fastenings sufficient redundancy of the entire system is required; Minimum of 5 nails per fastened track. All visible setting failures must be replaced
- Sheet metal failure is not considered in recommended loads and must be assessed separately
- Soft, medium concrete up to $f_{c,cube} = 45 \text{ N/mm}^2$ (C35/45), some tough concrete up to $f_{c,cube} = 60 \text{ N/mm}^2$ (C50/60).
- Concrete with aggregate like granite or river rock or softer, and up to 16 mm diameter

Stick rate estimation



Designation	Soft/medium concrete	Tough concrete
X-P G3	85–98%	70–85%
X-C G3	75–90%	55–70%



- The stick rate indicates the percentage of nails that were driven correctly to carry a load.
- Stick rate can vary from the above values depending on job site conditions.

Recommended loads and tightening torque for threaded studs

Designation	N_{rec}	V_{rec}	T_{rec}	Base material
X-M6-7-24 G3 P7	0.05 kN	0.05 kN	3.0 Nm	Concrete, sand-lime masonry
X-W6-12-20 G3 P7	0.05 kN	0.05 kN	3.0 Nm	
X-M6-7-14 G3 P7	0.2 kN	0.2 kN	3.0 Nm	Steel
X-W6-12-14 G3 P7	0.2 kN	0.2 kN	3.0 Nm	

Service loads for electrical elements

Designation	Maximum service load F_{max}
X-ECT (FR) MX	40 N
X-UCT MX	40 N
X-EKS MX	11 N
X-EKSC MX	32 N
X-FB MX / X-DFB MX	20 N
X-ECC MX	50 N
X-EHS MX	80 N
X-EKB (FR) 4 MX	9 N
X-EKB (FR) 8 MX	14 N
X-EKB (FR) 16 MX	18 N
X-ECH MX	40 N

Service loads for cable trunking

Designation	Maximum service load F_{max}
X-ET MX	100

Application recommendation

Thickness of base material

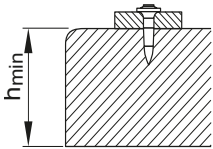

Concrete (for nails
and threaded studs)
 $h_{\min} = 60 \text{ mm}$

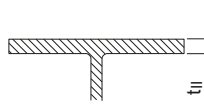

Steel
 $t_{II} \geq 4.0 \text{ mm}$ (for nails)
 $t_{II} \geq 6.0 \text{ mm}$ (for
threaded studs)

Thickness of fastened material

Wooden track: $t_1 \leq 25 \text{ mm}$

Metal track: $t_1 \leq 2 \text{ mm}$

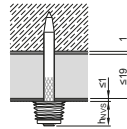

Deflection head:
 $t_{1,tot.} \leq 21 \text{ mm}$ (gypsum strip
+ metal track and sealant)

Spacing and edge distances (mm)

Spacing along track

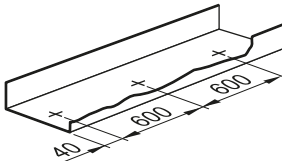

All track ends (cut-outs for doors),
secure with 2 nails

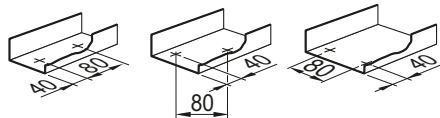

Fastener spacing max. 30 cm for proprietary
light non-load-bearing partition walls with
fire classification

Distance to edge of concrete / sand-lime masonry

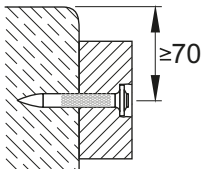

Spacing between nails when fastening wood to concrete

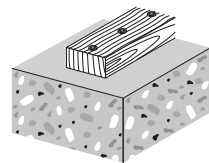
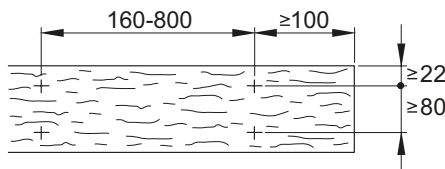

Distance to edge of fastened material (steel base material)

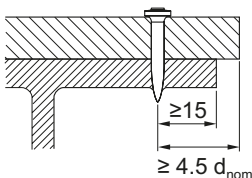

Application limits

X-S 14 G3 MX

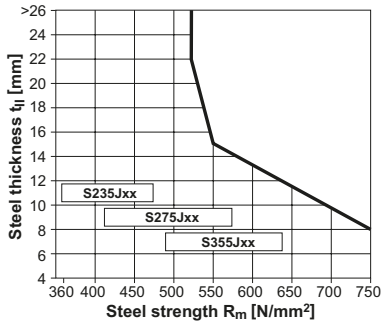

X-M6-7-14 G3 P7, X-W6-12-14 G3 P7

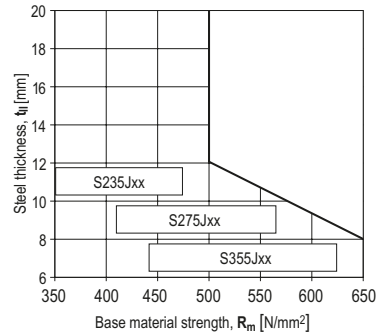

For temporary tacking of composite decks

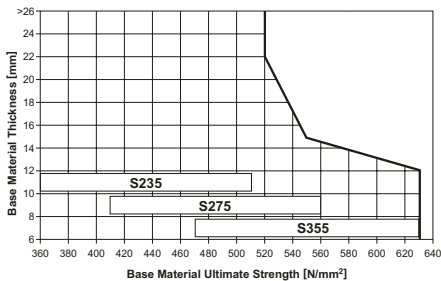

Design conditions

- Single layer sheet with a maximum thickness of 1.25 mm.
- Sheeting grade up to S450 acc. to EN 10346.
- Minimum base material thickness: 6 mm
- Minimum steel grade: S235 acc. to EN 10025-2

Corrosion information

- The intended use only comprises fastenings which are not directly exposed to external weather conditions or moist atmospheres, i.e. only intended for dry indoor areas.
- For more details, please refer to following technical document: Hilti Corrosion Handbook.

Fastener program and system recommendation

Fastener program









Nails

Designation	Item no.	Shank length	Shank diameter	Base material	Length recommendation		
X-S 14 G3 MX	2101547	14 mm	3 mm	Steel			
X-P 17 G3 MX	2101046	17 mm	3 mm	Concrete / Sand-lime masonry	↑ ↑	↑ ↑	↑ ↑
X-P 20 G3 MX	2101047	20 mm	3 mm				
X-P 24 G3 MX	2101048	24 mm	3 mm				
X-C 20 G3 MX	2100955	20 mm	3 mm				
X-C 27 G3 MX	2100956	27 mm	3 mm				
X-C 32 G3 MX	2100957	32 mm	3 mm				
X-C 39 G3 MX	2100958	39 mm	2.8 mm				

Threaded studs

Designation	Item no.	Thread size	Thread length	Shank length	Shank diameter	Base material
X-M6-7-14 G3 P7	2101052	M6	7 mm	14 mm	3 mm	Steel
X-M6-7-24 G3 P7	2101053	M6	7 mm	24 mm	3 mm	Concrete
X-W6-12-14 G3 P7	2101054	W6	12 mm	14 mm	3 mm	Steel
X-W6-12-20 G3 P7	2101055	W6	12 mm	20 mm	3 mm	Concrete

Fastener selection

	Nail Selector for GX 3			
	Hollow brick	Concrete		Steel
		Wall / Floor	Ceiling	
	X-C 27 G3 MX X-C 20 G3 MX	X-C 20 G3 MX	X-C 20 G3 MX X-P 17 G3 MX	X-S 14 G3 MX
	X-C 39 G3 MX X-C 32 G3 MX			
	X-C 27 G3 MX X-C 20 G3 MX	X-C 20 G3 MX	X-C 20 G3 MX X-P 17 G3 MX	X-S 14 G3 MX
	X-C 20 G3 MX		X-C 20 G3 MX X-P 17 G3 MX	X-S 14 G3 MX
	X-C 20 G3 MX		X-C 20 G3 MX X-P 17 G3 MX	X-S 14 G3 MX
	X-W6-12-20 G3 P7 X-M6-7-24 G3 P7			X-W6-12-14 G3 P7 X-M6-7-14 G3 P7
Gas can	 GC 40 / GC 41 / GC 42 - For all base materials			

For more details and information, please contact your nearest Hilti representative.

Fastener guide

Designation	Item no.	Description
X-FG G3	2102280	For use with nails or studs only
X-FG G3-ME	2102281	For use with nails + elements or only studs

Quality assurance

Fastening inspection

Nails and studs in concrete / sand-lime masonry

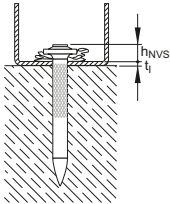

X-P_G3 MX, X-C_G3 MX:
 $h_{NVS} = 2-5 \text{ mm}$

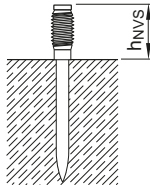

X-M6-7-24 G3 P7: $h_{NVS} \geq 7 \text{ mm}$
 X-W6-12-20 G3 P7: $h_{NVS} \geq 12 \text{ mm}$

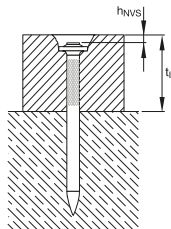

X-P_G3 MX, X-C_G3 MX:
 $h_{NVS} = 2-3 \text{ mm}$

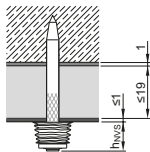

Deflection head – X-C 39 G3 MX:
 12.5 mm board: $h_{NVS} \leq 15 \text{ mm}$
 15 mm board: $h_{NVS} \leq 12 \text{ mm}$
 19 mm board: $h_{NVS} \leq 8 \text{ mm}$

Nails and studs in steel

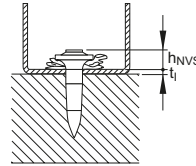

X-S 14 G3 MX: $h_{NVS} = 2-9 \text{ mm}$

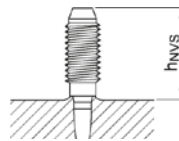

X-M6-7-14 G3 P7: $h_{NVS} \geq 7 \text{ mm}$
 X-W6-12-14 G3 P7: $h_{NVS} \geq 12 \text{ mm}$

Element	h_{NVS} (mm)	
	Concrete	Steel
X-EKB 4/8 MX	6-11	6-9
X-EKB 16 MX	6-11	6-9
X-ECT MX	6-11	6-9
X-UCT MX	6-11	6-9
X-ECH MX	6-11	6-9
X-EKS MX	6-11	6-9
X-EKSC MX	6-11	6-9
X-FB MX	7-11	7-9
X-DFB MX	7-11	7-9
X-ECC MX	7-11	7-9
X-EHS MX	7-11	7-9
X-ET MX*	5-10	5-9

Examples

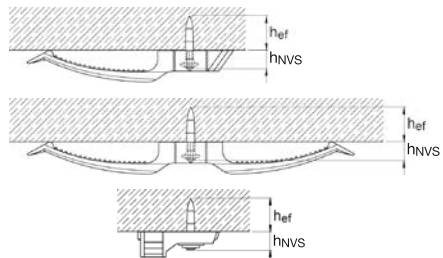

*) With X-ET MX, the h_{NVS} is measured against the cable trunk.

GX 2 System Fastener for interior finishing application

Product data

Dimensions

X-P 14 G2 MX

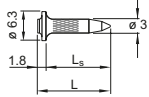

X-P 17 / 20 G2 MX

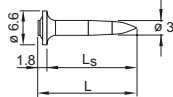

X-C 20 / 27 / 32 G2 MX

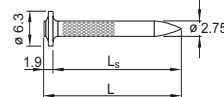

X-C 39 G2 MX

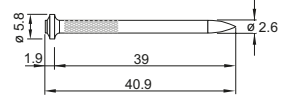

Material specifications

Carbon steel shank:

X-P G2

HRC 57.5

X-C G2

HRC 56.5

Zinc coating:

(X-P 14 G2 MX)

2–13 μm

up to 16 μm

Recommended fastening tool

GX 2



Approvals and certificates

ICC ESR-1752 (USA):

X-C 20 / 27 / 32 G2, X-P 14 / 17 / 20 G2



- Not all information presented in this product data sheet might be subject to approval/certificate content. Please refer to approval/certificate for further information.

Applications

Examples



Drywall tracks



Light-duty applications in construction

Performance data

Recommended resistance under tension and shear load for drywall track fastening

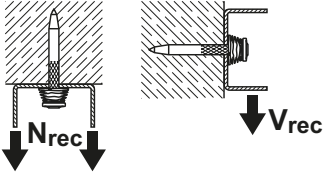

X-P 14 G2 MX (Base material: steel)

Tension N_{rec}	Shear V_{rec}
0.4 kN	0.4 kN

X-P G2, X-C G2 (Base material: concrete / sand-lime masonry)

Embedment	Tension N_{rec}		Shear V_{rec}		Tension N_{rec}	Shear V_{rec}
	Concrete Type					
	Soft/ medium	Tough	Soft/ medium	Tough		
≥ 22 mm	-	-	-	-	0.3 kN	0.3 kN
≥ 18 mm	0.2 kN	-	0.2 kN	-	0.2 kN	0.2 kN
≥ 14 mm	0.1 kN	0.1 kN	0.1 kN	0.1 kN	0.1 kN	0.1 kN

Conditions

- For safety relevant fastenings sufficient redundancy of the entire system is required; Minimum of 5 nails per fastened track. All visible setting failures must be replaced
- Sheet metal failure is not considered in recommended loads and must be assessed separately
- Soft, medium concrete up to $f_{c,cube} = 45 \text{ N/mm}^2$ (C35/45), some tough concrete up to $f_{c,cube} = 60 \text{ N/mm}^2$ (C50/60).
- Concrete with aggregate like granite or river rock or softer, and up to 16 mm diameter

Stick rate estimation



Designation	Soft/medium concrete	Tough concrete
X-P G2	85–98%	70–85%
X-C G2	75–90%	55–70%



- The stick rate indicates the percentage of nails that were driven correctly to carry a load.
- Stick rate can vary from the above values depending on job site conditions.

Application recommendation

Thickness of base material

Concrete

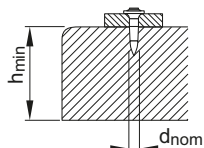

$h_{min} = 60 \text{ mm}$
 $(d_{nom} \leq 3.0 \text{ mm})$

Steel

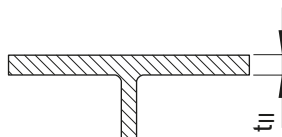

$t_{II} \geq 4.0 \text{ mm}$ (for nail)

Thickness of fastened material

Wooden track: $t_I \leq 25 \text{ mm}$

Metal track: $t_I \leq 2 \text{ mm}$

Spacing and edge distances (mm)

Spacing along track

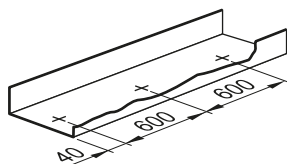

All track ends (cut-outs for doors),
 secure with 2 nails

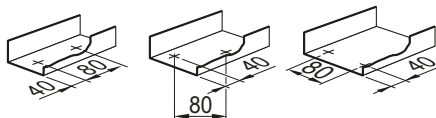

Edge distance for
 concrete/sand-lime masonry

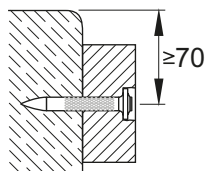

Fastener spacing on wood

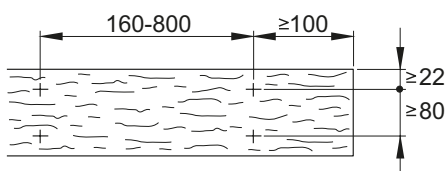

Edge distance for steel

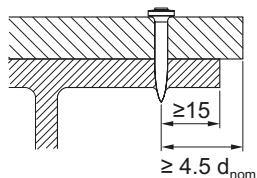

Application limits

Steel

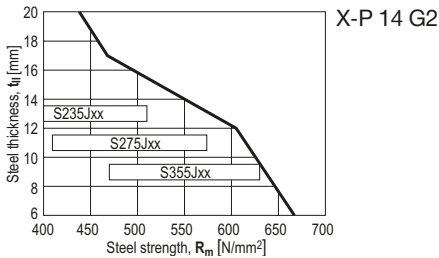

Corrosion information



- The intended use only comprises fastenings which are not directly exposed to external weather conditions or moist atmospheres.
- For more details, please refer to following technical document: Hilti Corrosion Handbook.

Fastener selection

	Nail Selector for GX 2			
	Brick	Concrete Wall / Floor	Ceiling	Steel
+	X-C 27 G2 MX X-C 20 G2 MX	X-C 20 G2 MX	X-C 20 G2 MX X-P 17 G2 MX	X-P 14 G2 MX
+	X-C 39 G2 MX X-C 32 G2 MX			
Gas can	GC 52 - For all base materials			

Quality assurance

Nails in concrete / sand-lime masonry

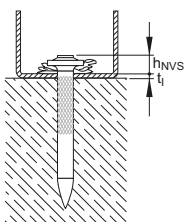

X-C / X-P G2 MX:
 $h_{NVS} = 2-5 \text{ mm}$

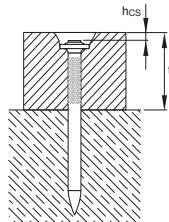

X-C 39 G2 MX and
 X-C 32 G2 MX:
 $h_{CS} = 2-3 \text{ mm}$

Nails in steel

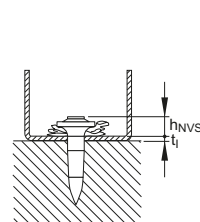

X-P 14 G2 MX:
 $h_{NVS} = 2-9 \text{ mm}$

BX 3 System Fastener for interior finishing, building construction, mechanical and electrical application

Product data

BX 3 battery-actuated direct fastening tools



BX 3-ME (02)
BX 3-IF



BX 3 02
BX 3-L 02

Features and benefits

- Hilti's combustion-free direct fastening technology for driving nails into concrete, steel and some types of solid masonry
- High user comfort thanks to low levels of compression force, noise and recoil
- No disposal of (used) propellant cartridges or gas cans
- Hilti's 22V cordless tool battery platform

Fasteners and their compatibility

Nails

For fastening to concrete
X-P 17/20/24 B3 MX
X-P 30/36 B3 P7
X-C 20/24/27/30 B3 MX

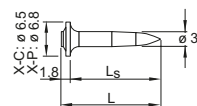

X-C 36 B3 MX

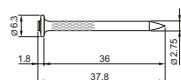

For fastening to steel
X-S 14 B3 MX

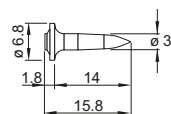

Threaded studs

For fastening to concrete
X-M6-7-24 B3 P7

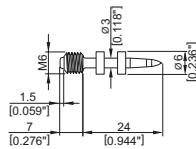

X-W6-12-20 B3 P7

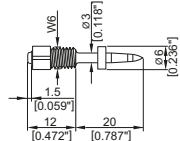

For fastening to steel
X-M6-7-14 B3 P7

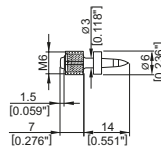

X-W6-12-14 B3 P7

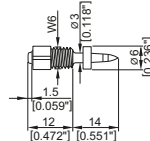

	BX 3-ME (02)	BX 3-IF	BX 3 02	BX 3-L 02
X-S 14 B3 MX	yes	yes	yes	yes
X-P 17 B3 MX	yes	yes	yes	yes
X-P 20 B3 MX	yes	yes	yes	yes
X-P 24 B3 MX	yes	yes	yes	yes
X-C 20 B3 MX	yes	yes	yes	yes
X-C 24 B3 MX	yes	yes	yes	yes
X-C 27 B3 MX	no	no	yes	yes
X-C 30 B3 MX	no	no	yes	yes
X-C 36 B3 MX	no	no	no	yes
X-M/W _ _ _ B3 P7	yes	yes	no	no
X-P _ B3 P7	yes	yes	no	no
ME MX elements	yes	with ME FG	with ME FG	with ME FG

General information

Material specifications

X-P B3 MX/P7, X-S B3 MX
X-C B3 MX

Carbon steel, HRC 57.5, 2-13 µm zinc coating
Carbon steel, HRC 56.5, 2-13 µm zinc coating

Electrical elements to be used with nails - examples

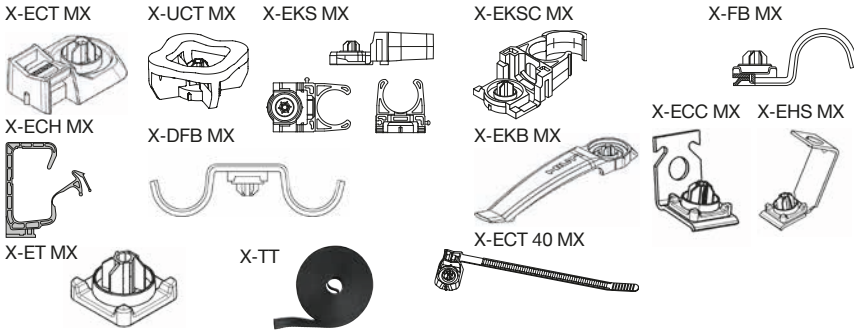

General information

Material specifications

X-ECT MX, X-EKS, X-EKSC MX, ECH MX
 X-EKB MX
 X-ECT-FR MX
 X-EKB-FR MX
 X-UCT MX, X-ET MX
 X-TT
 X-FB MX, X-DFB MX
 X-ECC MX, X-EHS MX

PA, halogen free, silicone free, light grey RAL 7035

PA, halogen free, light grey RAL 7035

PBT, silicone free, flame retardant, stone grey RAL 7030

PBT, silicone free, flame retardant, stone grey RAL 7030

HDPE, halogen free, silicone free, light grey RAL 7035

PET

Galvanized steel sheet, $f_u = 270-420 \text{ N/mm}^2$, 10–20 μm zinc coating

Galvanized steel sheet, $f_u = 270-420 \text{ N/mm}^2$, 10–20 μm zinc coating

Approvals

ICC-ESR 1752 (USA)
 ETA-16/0301

X-P 20 B3 MX, X-P 24 B3 MX, various electrical elements (see ETA approval Annex A1)

Applications

With nails



Drywall tracks to concrete and steel



Fastening wood, e.g. Placopan®, to concrete



Junction boxes, switch boxes, etc

With nails and elements



Flexible or rigid cable conduits with cable ties



Fastening cables



Cable conduits or light-duty pipes

Performance data

Performance data for drywall track fastening

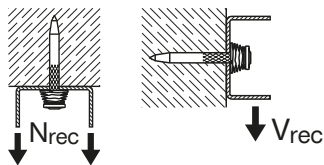

X-S 14 B3 MX (Base material: steel)

Tension N_{rec} [kN]	Shear V_{rec} [kN]
0.4	0.4

X-P B3, X-C B3 (Base material: concrete / sand-lime masonry)

Embedment [mm]	Recommended Loads [kN]					
	Tension N_{rec}		Shear V_{rec}		Tension N_{rec}	Shear V_{rec}
	Concrete Type				Sand-lime masonry	
	Soft	Tough	Soft	Tough		
≥ 22	-	-	-	-	0.3	0.3
≥ 18	0.2	-	0.2	-	0.2	0.2
≥ 14	0.1	0.1	0.1	0.1	0.1	0.1

Conditions:

- For safety relevant fastenings sufficient redundancy of the entire system is required; Minimum of 5 nails per fastened track. All visible setting failures must be replaced
- Sheet metal failure is not considered in recommended loads and must be assessed separately
- Soft concrete up to $f_{c,cube} = 45 \text{ N/mm}^2$ (C35/45), some tough concrete up to $f_{c,cube} = 60 \text{ N/mm}^2$ (C50/60).
- Concrete with aggregate like granite or river rock or softer, and up to 16 mm diameter



	Stick rate estimation	
	Soft Concrete	Tough concrete
X-P B3	85% - 98%	70% - 85%
X-C B3	75% - 90%	55% - 70%

- The stick rate indicates the percentage of nails that were driven correctly to carry a load. Stick rate can vary from the above values depending on job site conditions.

Performance data

Recommended loads (Threaded studs only)

Threaded stud	Recommended loads and tightening torque			Base material
	N_{rec} [kN]	V_{rec} [kN]	T_{rec} [Nm]	
X-M6-7-24 B3 P7	0.05	0.05	3.0	Concrete, sand-lime masonry
X-W6-12-20 B3 P7				
X-M6-7-14 B3 P7	0.2	0.2	3.0	Steel
X-W6-12-14 B3 P7				

Recommended loads (electrical elements used with nails)

Element	Maximum service load F_{max} [N]
X-ECT (FR) MX	40
X-UCT MX	40
X-EKS MX	11
X-EKSC MX	32
X-FB MX / X-DFB MX	20
X-ECC MX	50
X-EHS MX	80
X-EKB (FR) 4 MX	9
X-EKB (FR) 8 MX	14
X-EKB (FR) 16 MX	18
X-ECH MX	40
	Cable trunking
X-ET MX	100

Conditions:

- Spacing \leq 100 mm
- All visible failures must be replaced

Nail recommendation

For **concrete** base material

Nail types	Length [mm]	Tip	Shank Ø [mm]	Material	Hardness [HRC]	Coating [µm]
X-P B3 P7/MX	17-36	Long conical	3.0	Carbon steel	57.5	Zinc, 2-10

- Premium nails (as listed above) are recommended for use on soft and some tough concrete. For more details regarding nail classification and concrete types, please refer to **Concrete Fastener Selection** section in Hilti Direct Fastening Technology Manual (DFTM)
- X-P 17/20/24 B3 MX to be used with BX 3 02, BX 3-L 02, BX 3-ME (02) and BX 3-IF
- X-P 30/36 B3 P7 to be used with BX 3-ME (02) and BX 3-IF

For **concrete** base material

Nail types	Length [mm]	Tip	Shank Ø [mm]	Material	Hardness [HRC]	Coating [µm]
X-C B3 MX	20-30 36	Cut	3.0 2.75	Carbon steel	56.5	Zinc, 5-13

- Standard nails (as listed above) are recommended for use on soft concrete only. For more details regarding nail classification and concrete types, please refer to **Concrete Fastener Selection** section in Hilti Direct Fastening Technology Manual (DFTM)
- X-C 20/24/27/30 B3 MX to be used with BX 3 02
- X-C 20/24/27/30/36 B3 MX to be used with BX 3-L 02
- X-C 20/24 B3 MX to be used with BX 3-ME (02) and BX 3-IF

For **steel** base material

Nail types	Length [mm]	Tip	Shank Ø [mm]	Material	Hardness [HRC]	Coating [µm]
X-S 14 B3 MX	14	Long conical	3.0	Carbon steel	57.5	Zinc, 2-10

- X-S 14 B3 MX to be used with BX 3 02, BX 3-L 02, BX 3-ME (02) and BX 3-IF
- Please refer to next pages for application limits on steel base material

Application requirements

Thickness of base material

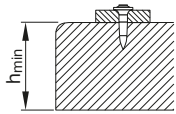

Concrete (for nails and threaded studs)
 $h_{\min} = 60 \text{ mm}$
 $d_{\text{nom}} = 3.0 \text{ mm}$

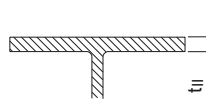

Steel
 $t_{II} \geq 4.0 \text{ mm}$ (for nails)
 $t_{II} \geq 6.0 \text{ mm}$ (for threaded studs)

Thickness of fastened material

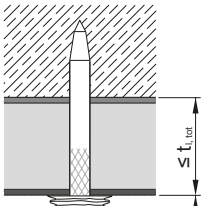

Wooden track: $t_{\perp} \leq 27 \text{ mm}$ (conditions: head of the nail is countersunk flat to the surface)
 Metal track: $t_{\perp} \leq 2 \text{ mm}$
 Deflection head: $t_{\text{tot.}} \leq 21 \text{ mm}$ (gypsum strip + metal track and sealant)

Spacing and edge distances (mm)

Max. spacing along track

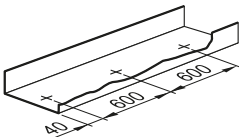

Fastener spacing max. 30 cm for proprietary light non-load-bearing partition walls with fire classification

All track ends (cut-outs for doors), secure with 2 nails

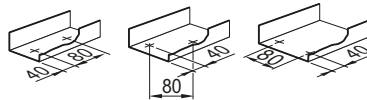

Distance to edge of concrete / sand-lime masonry

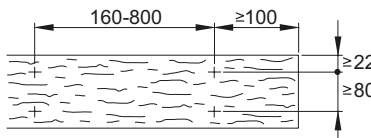
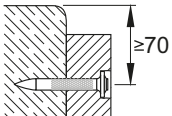

Spacing between nails when fastening wood to concrete

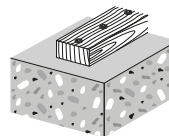

Based on common practice, spacing needs to be adjusted based on specific load requirement and achieved embedment depth.

Distance to edge of fastened material (steel base material)

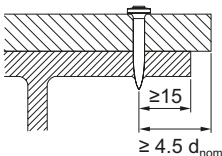

Application limits

X-S 14 B3 MX

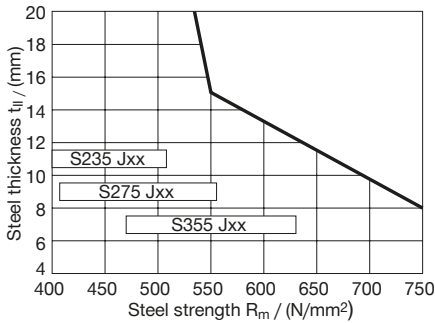

X-M6-7-14 B3 P7, X-W6-12-14 B3 P7

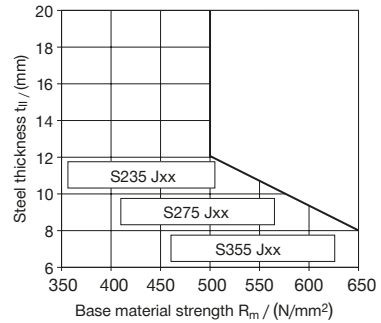

Corrosion information

The intended use only comprises fastenings which are not directly exposed to external weather conditions or moist atmospheres, i.e. only intended for dry indoor areas.

Fastener selection and system recommendation

Fastener program















Nails

Nail	Item no.	Shank length (mm)	Shank diameter (mm)	Base material	Length recommendation
X-S 14 B3 MX	2156392, 2156393	14	3	Steel	
X-P 17 B3 MX	2156216, 2156219	17	3	Concrete / Sand-lime masonry	
X-P 20 B3 MX	2156217, 2156390	20	3		
X-P 24 B3 MX	2156218, 2156391	24	3		
X-P 30 B3 P7	2105406	30	3		
X-P 36 B3 P7	2105407	36	3		
X-C 20 B3 MX	2123993	20	3		
X-C 24 B3 MX	2123994	24	3		
X-C 27 B3 MX	2224568	27	3		
X-C 30 B3 MX	2149988	30	3		
X-C 36 B3 MX	2149989	36	2.75		

Threaded studs







Threaded studs	Item no.	Thread size	Thread length (mm)	Shank length (mm)	Shank diameter (mm)	Base material
X-M6-7-14 B3 P7	2105408	M6	7	14	3	Steel
X-M6-7-24 B3 P7	2105409	M6	7	24	3	Concrete
X-W6-12-14 B3 P7	2105800	W6	12	14	3	Steel
X-W6-12-20 B3 P7	2105801	W6	12	20	3	Concrete

Fastener selection

	Nail Selector for BX 3-ME (02) and BX 3-IF 			
	Brick	Concrete Floor	Concrete Wall/Ceiling	Steel
 + 	X-C 24 B3 MX	X-C 20 B3 MX X-C 24 B3 MX	X-C 20 B3 MX X-P 17 B3 MX	X-S 14 B3 MX
 + 	-----	X-C 36 B3 P7	-----	-----
 + 	X-C 24 B3 MX X-C 20 B3 MX		X-P 20 B3 MX	X-S 14 B3 MX
 + 	X-P 20 B3 MX X-P 17 B3 MX	-----	X-P 17 B3 MX	X-S 14 B3 MX
 + 	-----	X-C 24 B3 MX X-C 20 B3 MX	-----	X-S 14 B3 MX
 + 	X-W6-12-20 B3 P7 X-M6-7-24 B3 P7			X-W6-12-14 B3 P7 X-M6-7-14 B3 P7
Propellant-free				

For more details and information, please contact your nearest Hilti representative.

Fastener selection

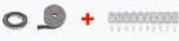
	Nail Selector for BX 3 02 and BX 3-L 02			
	Brick	Concrete Floor	Concrete Wall/Ceiling	
	X-C 24-36 B3 MX*	X-C 20 B3 MX X-C 24 B3 MX	X-C 20 B3 MX X-P 17 B3 MX	X-S 14 B3 MX
	-----	X-C 36 B3 MX*	-----	-----
	X-C 24 B3 MX X-C 20 B3 MX		X-P 20 B3 MX	X-S 14 B3 MX
	X-P 20 B3 MX X-P 17 B3 MX	-----	X-P 17 B3 MX	X-S 14 B3 MX
	-----	X-C 24 B3 MX X-C 20 B3 MX	-----	X-S 14 B3 MX
Propellant-free				

* X-C 36 B3 MX suitable for BX 3-L 02 only

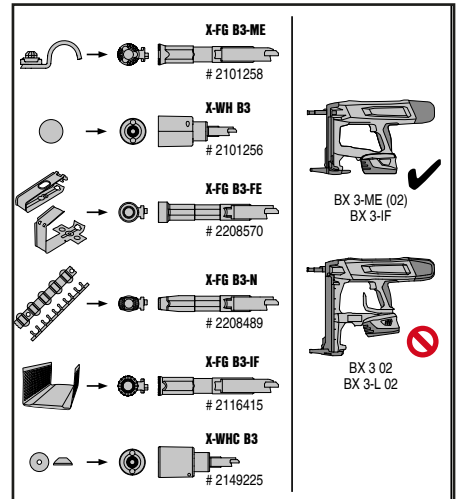
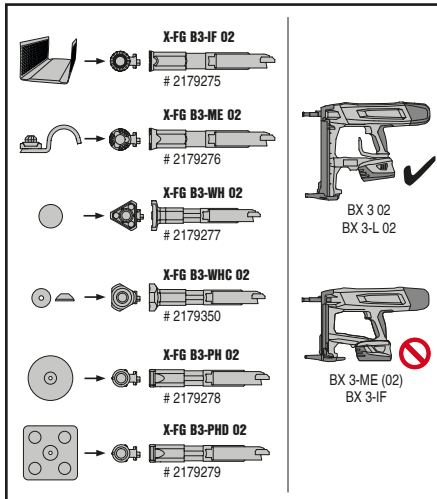

Fastening quality assurance

Fastening inspection

Nails and studs in concrete / sand-lime masonry

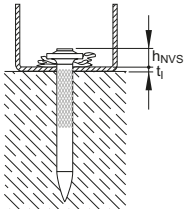

X-C_B3, X-P_B3:
 $h_{NVS} = 2-5 \text{ mm}$

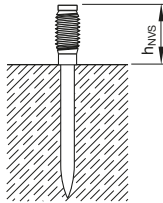

X-M6-7-24 B3 P7
X-W6-12-20 B3 P7

$h_{NVS} \geq 7 \text{ mm}$
 $\geq 12 \text{ mm}$

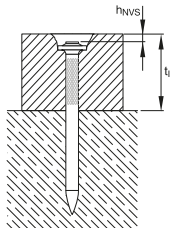

X-C_B3, X-P_B3:
 $h_{NVS} = 2-3 \text{ mm}$

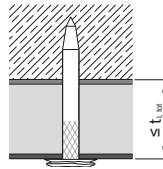

Deflection head
X-P 36 B3 P7, X-C 36 B3 MX
12.5 mm board: $h_{NVS} \leq 12 \text{ mm}$
15 mm board: $h_{NVS} \leq 9 \text{ mm}$
19 mm board: $h_{NVS} \leq 5 \text{ mm}$

Nails and studs in steel

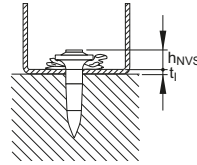

X-S_B3:
 $h_{NVS} = 2-9 \text{ mm}$

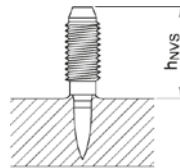

X-M6-7-14 B3 P7
X-W6-12-14 B3 P7

$h_{NVS} \geq 7 \text{ mm}$
 $\geq 12 \text{ mm}$

Element	h_{NVS} (mm)	
	Concrete	Steel
X-EKB 4/8 MX	6-11	6-9
X-EKB 16 MX	6-11	6-9
X-ECT MX	6-11	6-9
X-UCT MX	6-11	6-9
X-ECH MX	6-11	6-9
X-EKS MX	6-11	6-9
X-EKSC MX	6-11	6-9
X-FB MX	7-11	7-9
X-DFB MX	7-11	7-9
X-ECC MX	7-11	7-9
X-EHS MX	7-11	7-9
X-ET MX*	5-10	5-9

Examples

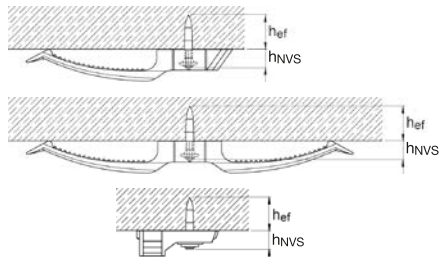

*) With X-ET MX, the h_{NVS} is measured against the cable trunk.

BX-Kwik Electrical hanger system

Product data

X-EHS MX



X-P 24 B3 MX

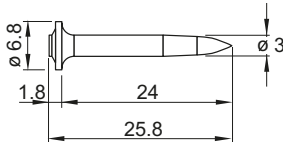

Features and benefits

A special hanger system with pre-drilled pilot hole optimized for higher load and close to **100% stick rate** for applications on **soft & tough** concrete.

General information

The system consists of:

- X-EHS MX hanger
- TX-C-5/10B drill bit
- X-P 24 B3 MX nail
- BX 3 ME

Material Specifications

Hanger:

Zinc coating $\geq 10 \mu\text{m}$

Nail:

Carbon Steel 57.5 HRC

Zinc Coating 2 – 10 μm

Applications

Examples



Threaded rod attachments to concrete



Cable trays

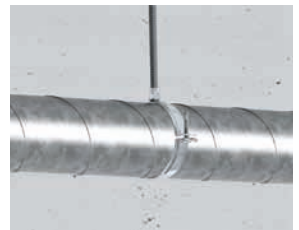

Small pipes

These zinc coated fasteners are not suitable for long-term service outdoors or in otherwise corrosive environments. For further detailed information on corrosion see chapter **Direct Fastening Principles and Technique**.

These fasteners are not recommended for fastening of suspended ceilings.

Performance data on concrete

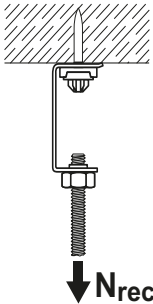

Recommended Tension Load N_{rec} [kN]	
Concrete Toughness ¹⁾	
Soft 0.3	Tough 0.45

Stick rate estimation ¹⁾	
Soft Concrete 95-100 %	Tough Concrete 95-100 %

Conditions:

- A sufficient redundancy has to be ensured, that a failure of a single fastening will not lead to collapse of the entire system.
- Soft concrete up to $f_{c,cube} = 45 \text{ N/mm}^2$ (C35/45).
- Tough concrete up to $f_{c,cube} = 60 \text{ N/mm}^2$ (C50/60).
- Concrete with aggregate like granite or river rock or softer, and up to 16 mm diameter.
- Loads valid for cracked and uncracked concrete.

¹⁾ The stick rate indicates the percentage of nails that were driven correctly to carry a load. Stick rate can vary from the above value depending on job site conditions.

For more details regarding fastener behaviour and concrete types, please refer to

Concrete Fastener Selection section.

Application requirements

Thickness of base material

Concrete:

$h_{min} = 60 \text{ mm}$

Edge distance and fastener spacing

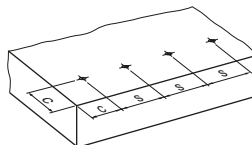

Edge distance: $c \geq 70 \text{ mm}$

Spacing: $s \geq 100 \text{ mm}$

Installation

Pre-drilling details

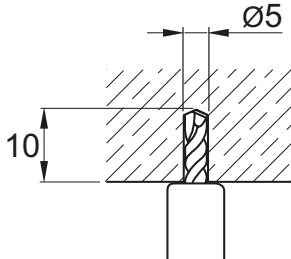

Pre-drilling with Hilti drill bit **TX-C-5/10B** until a ring on the concrete surface is visible.

Fastener selection and system recommendation

Fastener program

Hanger	Item no.
X-EHS M4 MX	273367
X-EHS M6 MX	272073
X-EHS M8 MX	273368

Nail	Item no.
X-P 24 B3 MX	2105405

Drill-bit	Item no.
TX-C-5/10B	2178329

Fastening quality assurance

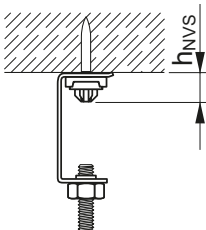

$h_{NVS} = 4.0 - 7.0 \text{ mm}$

X-HS and X-CC Threaded hanger and loop hanger system

Product data

Dimensions

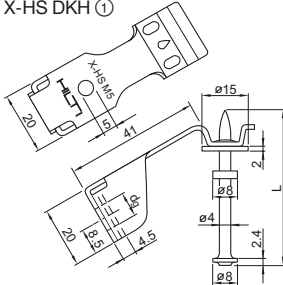
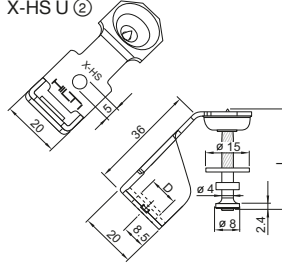
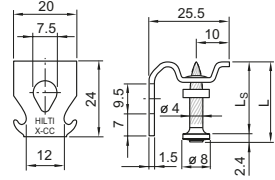
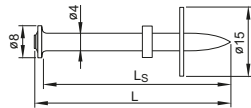
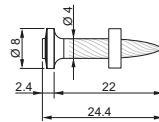
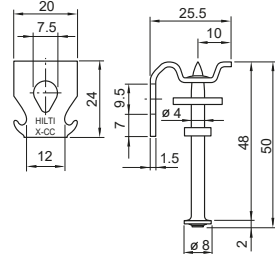
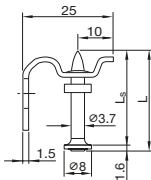
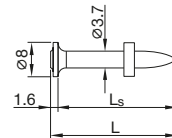
X-HS DKH ①

X-HS U ②

X-CC U ③

DKH 48 P8S15

X-U_P8

X-CC DKH 48 P8 S15 ③

X-CC CS

X-CS_P8

Material specifications

Carbon steel shank: HRC 58 X-HS M _ DKH, X-HS M/W_U, X-CC_U
 HRC 56 X-CC_CS

X-HS: Zinc coating: 10 μ m

X-CC U: Zinc coating: 2.5 μ m

X-CC CS : Zinc coating: \geq 5 μ m

X-U / DKH Nail: Zinc coating: 5–20 μ m

X-CS Nail: Zinc coating: 5–20 μ m

Recommended fastening tools

DX 6 F8, DX 5 F8, DX 460-F8, DX 351-F8, DX 36, DX 2, DX E72



• See system recommendation in the next pages.

Approvals and certificates

Lloyds Register: X-HS
 ICC, UL, FM: X-HS W6/10

Not all information presented in this product data sheet might be subject to approval / certificate content. Please refer to approval / certificate for further information.

Applications

Examples

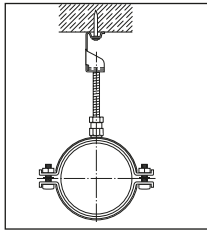

Threaded rod attachments to concrete and steel

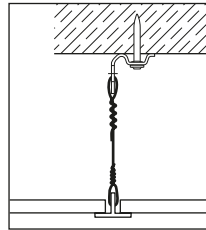
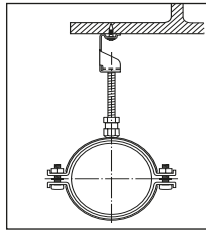

Wire attachments to concrete and steel

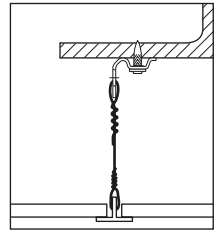

Performance data

Recommended resistance under tension and shear load

Concrete (DX-Kwik with pre-drilling) or steel

X-HS

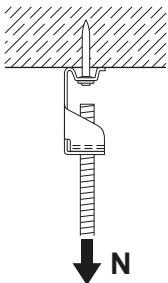

X-CC

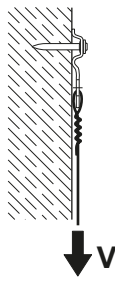
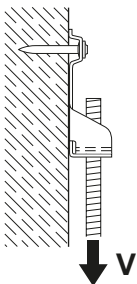
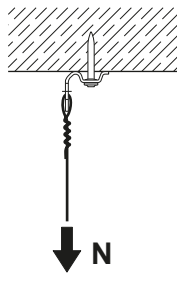

Designation

$N_{rec} = V_{rec}$

Base material

X-HS __ DKH 48	0.9 kN	Concrete
X-HS __ U19	0.9 kN	Steel
X-CC DKH 48	0.9 kN	Concrete
X-CC U16	0.9 kN	Steel

Conditions

- Predominantly static loading.
- Concrete C20/25–C50/60
- Strength of fastened material is not limiting.
- Observance of all application limitations and recommendations (especially pre-drilling requirements).

Concrete (DX Standard without pre-drilling)

X-HS

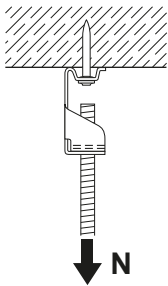

X-CC

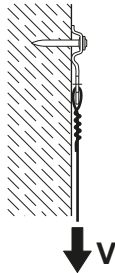
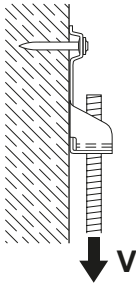
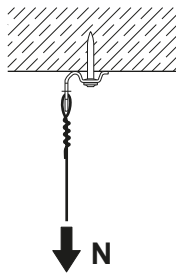

Designation	N_{rec}	V_{rec}	h_{ET}
X-HS_U32	0.4 kN	0.4 kN	27 mm
X-HS_U27	0.3 kN	0.3 kN	22 mm
X-HS_U22	0.2kN	0.2 kN	18 mm
X-CC_U27	0.2* kN	0.3 kN	22 mm
X-CC_U22	0.15* kN	0.2 kN	18 mm
X-CC_CS27	0.2 kN	0.3 kN	22 mm
X-CC_CS22	0.15 kN	0.2 kN	18 mm

*) eccentric loading considered

Conditions

- Minimum 5 fasteners per fastened unit (normal weight concrete).
- All visible failures must be replaced.
- With lightweight concrete base material and appropriate washers, greater loading may be possible, please contact Hilti.
- Predominantly static loading.
- Observance of all application limitations and recommendations.



- For more details in relation to base material properties, please refer to the chapter **Fastener selection guide** in the Direct Fastening Manual (DFTM).

Application recommendation

Base material thickness

Concrete

DX-Kwik

(with pre-drilling) $h_{min} = 100$ mm

DX Standard

(w/o pre-drilling) $h_{min} = 80$ mm

Steel

$t_{II} \geq 4$ mm

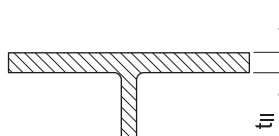

Fastener positioning

Minimum spacing and edge distances: See corresponding nail data sheet of X-U and X-DKH.

Application limits

Fastening to steel – X-HS U19 with DX351

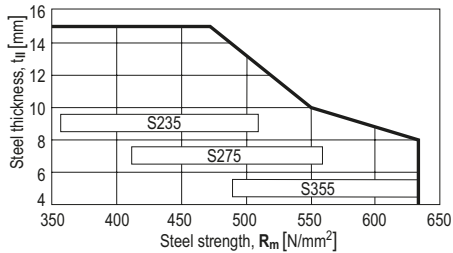

Application limit may increase in case of specific applications, like the fastening of wire mesh to steel, which is connected with X-CC U16 P8 fasteners. That wire mesh acts as reinforcement for fire protective sprayed coating. In such cases also different fastener stand-offs apply. Inquire at Hilti related with the use of X-CC U16 P8 in that specific application.

Corrosion information



- These zinc-coated fasteners are not suitable for long-term service outdoors or in otherwise corrosive environments.
- For more details, please refer to following technical document: Hilti Corrosion Handbook.

System recommendation

- For more details, please refer to the chapter **Accessories and consumables compatibility** in the Direct Fastening Technology Manual (DFTM).

Technical information

Designation	Shank diameter d_s	Shank length L_s	Fastener length L	Base material	Tools
① X-HS_ DKH 48 P8S15	4.0 mm	48 mm	50.0 mm	Concrete pre-drilled	DX 6 F8, DX 5 F8, DX 460-F8
② X-HS_ U 32 P8S15	4.0 mm	32 mm	34.4 mm	Concrete	DX 6 F8,
② X-HS_ U 27 P8S15	4.0 mm	27 mm	29.4 mm	Concrete	DX 5 F8,
② X-HS_ U 22 P8S15	4.0 mm	22 mm	24.4 mm	Concrete	DX 460-F8,
② X-HS_ U 19 P8S15	4.0 mm	19 mm	21.4 mm	Steel	DX 351-F8, DX 36, DX 2
③ X-CC DKH 48 P8S15	4.0 mm	48 mm	50.0 mm	Concrete pre-drilled	DX 6 F8, DX 5 F8, DX 460-F8
③ X-CC U 27 P8	4.0 mm	27 mm	29.4 mm	Concrete	DX 6 F8,
③ X-CC U 22 P8	4.0 mm	22 mm	24.4 mm	Concrete	DX 5 F8,
③ X-CC U 16 P8	4.0 mm	16 mm	18.4 mm	Steel	DX 460-F8, DX 351-F8, DX 36, DX 2

Cartridge recommendation for fastening on concrete

Base material	Cartridge color (tool power level)	
	Tool type: DX 6 F8	Tool type: DX 5 F8, DX 460 F8, DX 2, DX 351 F8
	Cartridge type: 6.8/11 M	Cartridge type: 6.8/11 M
Soft/medium concrete	titanium ■ (2-5)	yellow ■, red ■
Tough concrete	titanium ■ (4-8)	yellow ■, red ■

Cartridge recommendation for fastening on steel

Base material		Cartridge color (tool power level)	
		Tool type: DX 6 F8	Tool type: DX 5 F8, DX 460 F8, DX 2, DX 351 F8
		Cartridge type: 6.8/11 M	Cartridge type: 6.8/11 M
S235,	$4 \leq t_{\parallel} \leq 6 \text{ mm}$	titanium ■ (1-3)	green ■
S275,	$6 < t_{\parallel} \leq 14 \text{ mm}$	titanium ■ (4-8)	red ■
S355			



- Tool power level adjustment by setting tests on site.
- Start tool energy selection with lowest recommended tool power level.
- Correct according requirement from chapter quality assurance.

Quality assurance

Installation

X-HS

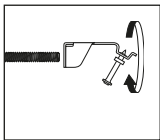

1. Attach the threaded rod to the X-HS before fastening

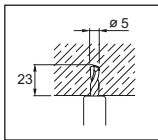

2. For DKH 48 pre-drill (Ø 5 x 23)

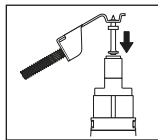

3. Load the assembly into the tool

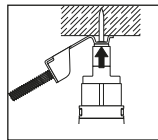

4. Locate the nail, compress the tool, pull the trigger and the fastening is complete

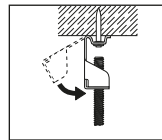

5. Bend the X-HS assembly down to the vertical position

X-CC

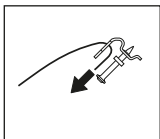

1. Assemble the wire with the X-CC

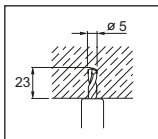

2. For DKH 48 pre-drill (Ø 5 x 23)

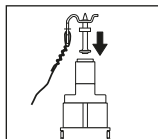

3. Load the assembly into the tool

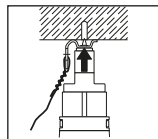

4. Locate the nail, compress the tool, pull the trigger and the fastening is complete

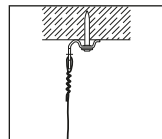

5. Adjust the wire as required

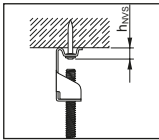
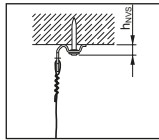
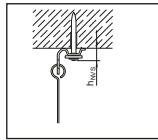
Setting depth control
X-HS

 $h_{NVS} = 6-10 \text{ mm}$
X-CC

 $h_{NVS} = 4-7 \text{ mm}$
X-CC DKH48 P8 S15

 $h_{NVS} = 6-10 \text{ mm}$

These are abbreviated instructions which may vary by application.

ALWAYS review/follow the instructions accompanying the product.

Fastener program

Item no. and description

X-HS order information

Item no.	Designation	Item no.	Designation
361788	X-HS M6 U32 P8 S15	386214	X-HS M8 U19 P8 S15
386223	X-HS M6 U27 P8 S15	386215	X-HS M10 U19 P8 S15
361789	X-HS M8 U32 P8 S15	386217	X-HS W10 U19 P8 S15
386224	X-HS M8 U27 P8 S15	386218	X-HS M6 U22 P8 S15
361790	X-HS M10 U32 P8 S15	386219	X-HS M8 U22 P8 S15
386225	X-HS M10 U27 P8 S15	386222	X-HS W10 U22 P8 S15
386226	X-HS W6 U27 P8 S15	386216	X-HS W6 U19 P8 S15
386227	X-HS W10 U27 P8 S15	386220	X-HS M10 U22 P8 S15
386213	X-HS M6 U19 P8 S15	386221	X-HS W6 U22 P8 S15



• Type of threading: M = metric; W6, W10 = Whitworth 1/4"; 3/8"

X-CC order information

Item no.	Designation
386229	X-CC U22 P8
386230	X-CC U27 P8
299937	X-CC DKH P8 S15
386228	X-CC U16 P8
2006454	X-CC CS22 P8
2005065	X-CC CS27 P8

X-MW MX, X-MW ALH Wire hanging system

X-WS Wire hanging system designation

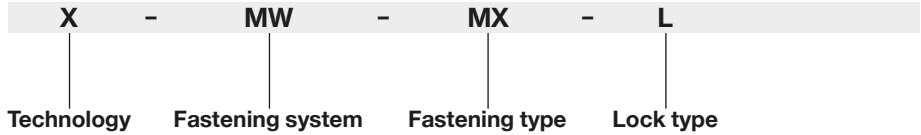

Technology:

X | Direct Fastening (DX) solution

Fastening system:

MW MX | Wire hanging system fastened with battery-actuated
magazined fastener

MW ALH | Wire hanging system with pre-mounted powder-actuated
fastener

Fastening type:

MX | Magazined fastener

ALH | Pre-mounted fastener

Lock type:

L | Loop lock

X-MW MX, X-MW ALH Wire hanging system

Product data

Product description



- X-MW MX fastening system for fastening heating, ventilation, and air condition (HVAC), cable tray, conduit rack and lighting to ceiling
- System can be mounted with battery-actuated fasteners X-P 20 B3 MX, X-P 24 B3 MX, X-S 14 B3 MX
- Wire length: 2 m, 3 m and 6 m
- Loop lock



- X-MW ALH fastening system for fastening heating, ventilation, and air condition (HVAC), cable tray, conduit rack and lighting to ceiling
- System can be mounted with powder-actuated pre-mounted fasteners X-ALH 22/27/32
- Wire length: 2 m, 3 m and 6 m
- Loop lock

Fastening system

	Designation		
			Pre-mounted
Designation	X-P 20/24 B3 MX	X-S 14 B3 MX	X-ALH 22/27/32
X-MW MX	■	■	
X-MW ALH			■

■ = suitable for combination

□ = suitable for combination, requires expert evaluation

Dimensions

Dimensions for elements

Technical drawing	Designation	Width w	Length l	Height h	Thickness t
	X-MW MX	30 mm	65 mm	21 mm	1.2 mm
	X-MW ALH	20 mm	30 mm	22.5 mm	1.5 mm
	Loop lock	12.5 mm	23 mm	18 mm	-



- Wire diameter $d \leq 2$ mm

Material specification and material properties for steel elements

Designation	Element	Material	Coating	Minimum coating thickness
X-MW MX	Wire holder plate	Carbon steel	Zinc	3 μ m
X-MW ALH	Wire holder plate	Carbon steel	Zinc	3 μ m
	Wire	Carbon steel	Zinc	3 μ m
	Loop lock	Aluminum, brass	Nickel	-

Approvals and certificates

Authority	Approval/ certificate no.	Date of issue	Short description
UL Listing	E522519	09/2021	Luminaire fittings certified for Canada, model(s): X-MW ALH27 L 10ft/3m, X-MW ALH27 L 20ft/6m, X-MW ALH27 L 6ft/2m, X-MW ALH32 L 10ft/3m, X-MW MX L 10ft/3m, X-MW MX L 20ft/6m, X-MW MX L 6ft/2m.



- Not all information presented in this product data sheet might be subject to approval/certificate content. Please refer to approval/certificate for further information.

Application
Spiral HVAC

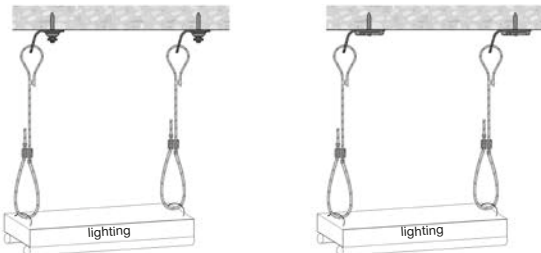
Lighting

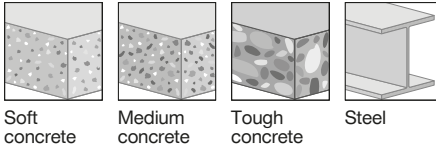
Base materials

Soft concrete

Medium concrete

Tough concrete

Steel

Load conditions

 Static/
quasi static

Recommended angle between wires at loop lock

 Maximum angle between wires: $\alpha \leq 60^\circ$
Environmental conditions

		Designation		
Environmental condition		X-MW MX combined with X-P 20/24 B3 MX, loop lock and wire	X-MW MX combined with X-S 14 B3 MX, loop lock and wire	X-MW ALH combined with X-ALH 22/27/32, loop lock and wire
	Dry indoor	■	■	■

■ = suitable

□ = requires expert evaluation

• For more details, please refer to following technical document(s): Hilti Corrosion Handbook.

Fastener program

Item no. and description

Designation	Item no.	Description
X-MW MX, Ø 2 mm, L 6ft/2m	2325727	Wire hanging system with loop lock and wire
X-MW MX, Ø 2 mm, L 10ft/3m	2325728	
X-MW MX, Ø 2 mm, L 20ft/6m	2325729	
X-MW ALH 22, Ø 2 mm, L 10ft/3m	2325738	
X-MW ALH 27, Ø 2 mm, L 6ft/2m	2325730	
X-MW ALH 27, Ø 2 mm, L 10ft/3m	2325731	
X-MW ALH 27, Ø 2 mm, L 20ft/6m	2325732	
X-MW ALH 32, Ø 2 mm, L 10ft/3m	2325733	

X-MW MX, X-MW ALH for fastening to concrete

Performance data

Recommended resistance under tension and shear load

Designation	Embedment depth h_{ET}	Tension load		Shear load	
		N_{rec}		V_{rec}	
Fastening system		Soft/ medium concrete	Tough concrete	Soft/ medium concrete	Tough concrete
X-MW MX + X-P 20/24 B3 MX	≥ 16 mm	0.05 kN	–	0.05 kN	–
X-MW ALH 22 (X-ALH 22)	≥ 18 mm	0.1 kN	0.1 kN	0.1 kN	0.1 kN
X-MW ALH 27 (X-ALH 27)	≥ 22 mm	0.1 kN	0.1 kN	0.1 kN	0.1 kN
X-MW ALH 32 (X-ALH 32)	≥ 26 mm	0.1 kN	0.1 kN	0.1 kN	0.1 kN

- Redundancy of fastening points is required.
- Minimum number of fastening points for safety relevant fastening: ≥ 5.
- For more details in relation to base material properties, please refer to the chapter Fastener selection guide in the Direct Fastening Manual (DFTM).

Stick rate estimation

	Designation	Soft/medium concrete	Tough concrete
	X-MW MX + X-P 20/24 B3 MX	95–100 %	–
	X-MW ALH 22 (X-ALH 22)	95–100 %	90–95 %
	X-MW ALH 27 (X-ALH 27)	95–100 %	90–95 %
	X-MW ALH 32 (X-ALH 32)	90–95 %	85–95 %

- The stick rate indicates the percentage of nails that were driven correctly to carry a load.
- Stick rate can vary from the above values depending on job site conditions.

System recommendation

System recommendation for fastening collated nails with battery-actuated tools

Designation	Battery-actuated tool			Base material		
	BX 3 ME 02	Soft concrete	Medium concrete	Tough concrete		
X-MW MX + X-P 20/24 B3 MX	■	■	■			

■ = recommended

□ = feasible

System recommendation for fastening pre-mounted nails with powder-actuated tools

Designation	Powder-actuated tool						Base material		
	DX 6 F8	DX 5 F8	DX 460 F8	DX 351 CT	DX 351 ME	DX 2	Soft concrete	Medium concrete	Tough concrete
X-MW ALH 22 (X-ALH 22)	■	□	□	■	■	■	■	■	■
X-MW ALH 27 (X-ALH 27)	■	□	□	■	■	■	■	■	■
X-MW ALH 32 (X-ALH 32)	■	□	□				■	■	■

■ = recommended

□ = feasible



- For more details, please refer to the chapter **Accessories and consumables compatibility** in the Direct Fastening Technology Manual (DFTM).

Cartridge recommendation

Base material	Cartridge color (tool power level)		
	Fastening system: X-MW ALH 22 (X-ALH 22)	Fastening system: X-MW ALH 27 (X-ALH 27)	Fastening system: X-MW ALH 32 (X-ALH 32)
	Tool type: DX 6 F8	Tool type: DX 6 F8	Tool type: DX 6 F8
	Cartridge type: 6.8/11 M	Cartridge type: 6.8/11 M	Cartridge type: 6.8/11 M
Soft/medium concrete	titanium ■ (4-5)	titanium ■ (4-5)	titanium ■ (6-8) to black ■ (7-8)
Tough concrete	titanium ■ (4-5)	titanium ■ (6-8)	titanium ■ (6-8) to black ■ (7-8)

Base material	Cartridge color (tool power level)		
	Fastening system: X-MW ALH 22 (X-ALH 22)	Fastening system: X-MW ALH 27 (X-ALH 27)	Fastening system: X-MW ALH 32 (X-ALH 32)
	Tool type: DX 5 F8, DX 460 F8, DX 351 CT, DX 351 ME, DX 2	Tool type: DX 5 F8, DX 460 F8, DX 351 CT ¹⁾ , DX 351 ME ¹⁾ , DX 2 ¹⁾	Tool type: DX 5 F8, DX 460 F8
	Cartridge type: 6.8/11 M	Cartridge type: 6.8/11 M	Cartridge type: 6.8/11 M
Soft/medium concrete	yellow ■, red ■	red ■	red ■, black ■
Tough concrete	red ■	red ■, black ■	black ■

¹⁾ Black cartridges do not apply for this tool.



- Tool power level adjustment by setting tests on site.
- Start tool energy selection with lowest recommended tool power level.
- Correct according requirement from chapter quality assurance.

Quality assurance

Admissible fastener stand-off for
X-MW MX

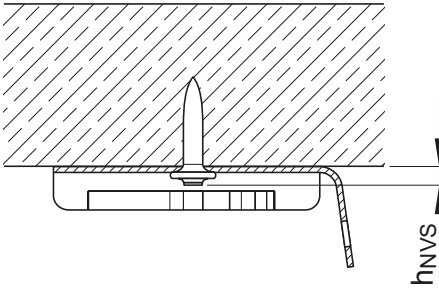

$$h_{NVS, \min} = 3 \text{ mm}$$

$$h_{NVS, \max} = 9 \text{ mm}$$

Admissible fastener stand-off
X-MW ALH 22 (X-ALH 22)
X-MW ALH 27 (X-ALH 27)
X-MW ALH 32 (X-ALH 32)

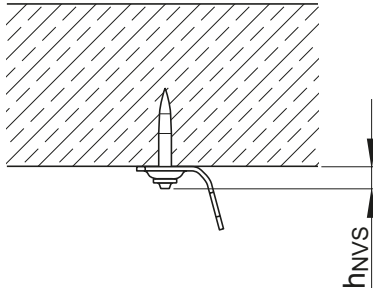

$$h_{NVS, \min} = 6 \text{ mm}$$

$$h_{NVS, \max} = 11 \text{ mm}$$



- Visible setting failures must be replaced with a new fastener, not in the same hole.
- These are abbreviated instructions which may vary by application.
- Always review/follow the instructions accompanying the product.

X-MW MX, X-MW ALH for fastening to steel

Performance data

Recommended resistance under tension and shear load

Designation	Embedment depth h_{ET}	Tension load N_{rec}	Shear load V_{rec}
Fastening system		S235, S275, S355	S235, S275, S355
X-MW MX + X-S 14 B3 MX	≥ 5 mm	0.45 kN	0.45 kN
X-MW ALH 22 (X-ALH 22)	≥ 15 mm	0.45 kN	0.45 kN

- Redundancy of fastening points is required.
- Minimum number of fastening points for safety relevant fastening: ≥ 5 .
- For more details in relation to base material properties, please refer to the chapter Fastener selection guide in the Direct Fastening Manual (DFTM).

Application recommendation

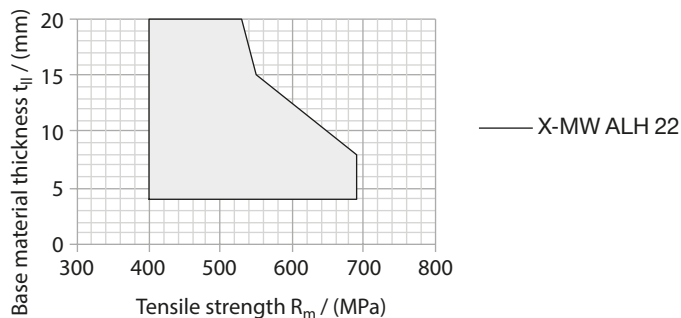
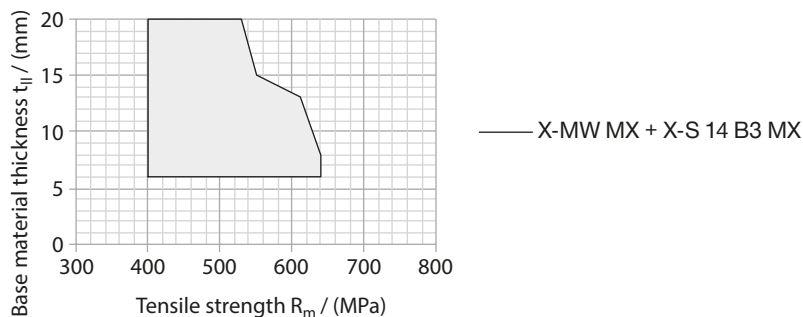

- Application area covered by polygon.

System recommendation

System recommendation for fastening collated nails with battery-actuated tools

Designation	Battery-actuated tool			Base material		
			BX 3 ME 02	Steel S235	Steel S275	Steel S355
X-MW MX + X-S 14 B3 MX	■			■	■	■

■ = recommended

□ = feasible

System recommendation for fastening pre-mounted nails with powder-actuated tools

Designation	Powder-actuated tool			Base material		
	DX 6 F8	DX 5 F8	DX 460 F8	Steel S235	Steel S275	Steel S355
X-MW ALH 22 (X-ALH 22)	■	□	□	■	■	■

■ = recommended

□ = feasible



- For more details, please refer to the chapter **Accessories and consumables compatibility** in the Direct Fastening Technology Manual (DFTM).

Cartridge recommendation

Base material		Cartridge color (tool power level)	
		Fastening system: X-MW ALH 22 (X-ALH 22)	
		Tool type: DX 6 F8	Tool type: DX 5 F8, DX 460 F8
		Cartridge type: 6.8/11 M	Cartridge type: 6.8/11 M
S235 to S355	$6 \leq t_{II} \leq 20 \text{ mm}$	titanium ■ (6-8), black ■ (7-8)	red ■, black ■

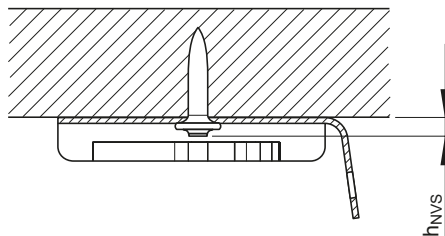

- Tool power level adjustment by setting tests on site.
- Start tool energy selection with lowest recommended tool power level.
- Correct according requirement from chapter quality assurance.

Quality assurance
**Admissible fastener stand-off for
X-MW MX**

$$h_{NVS, \min} = 3 \text{ mm}$$

$$h_{NVS, \max} = 7 \text{ mm}$$

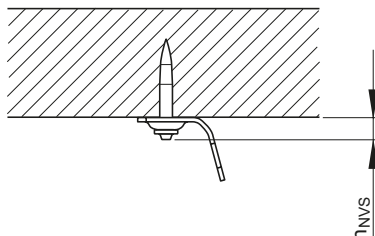
**Admissible fastener stand-off for
X-MW ALH 22 (X-ALH 22)**

$$h_{NVS, \min} = 6 \text{ mm}$$

$$h_{NVS, \max} = 11 \text{ mm}$$



- Visible setting failures must be replaced with a new fastener, not in the same hole.
- These are abbreviated instructions which may vary by application.
- Always review /follow the instructions accompanying the product.



X-EHS MX, X-ECC MX Electrical hanger system

Product data

Dimensions

X-EHS MX

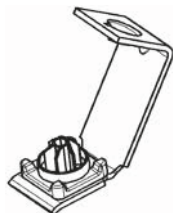

X-ECC MX

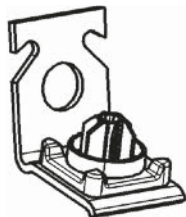

Material specifications

X-EHS MX / X-ECC MX:

Zinc coating: $\geq 5 \mu\text{m}$

Recommended fastening tools

DX 6 MX, DX 5 MX, DX 460 MX, DX 351 MX,
DX 6 F8, DX 5 F8, DX 460 F8, DX 351, DX 2,
GX 120 ME, GX 3 ME, BX 3 ME



• See fastener program in the next pages.

X-GHP 20/24

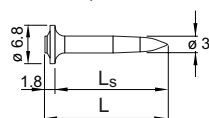

X-EGN 14

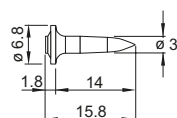

X-P 20/24 G3 MX

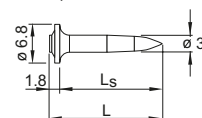

X-P 20/24 B3 MX

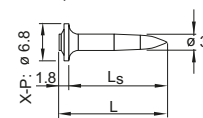

X-U 16/22

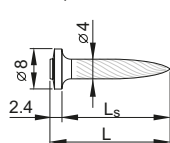

X-P 22

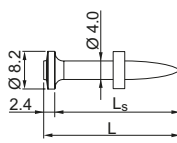

X-S 14 G3 MX

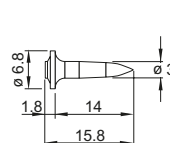

X-S 14 B3 MX

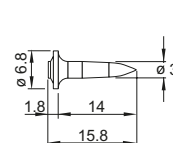

Applications

Example

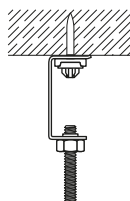

- Hanger systems for light cable trays, etc. threaded rod attachments, wire attachments
- These fasteners are not recommended for fastening of suspended ceilings.
- These zinc coated fasteners are not suitable for long-term service outdoors or in otherwise corrosive environments.

Performance data

Recommended resistance under tension and shear load on concrete

Designation	N_{rec}	V_{rec}
X-EHS MX	0.1 kN	0.1 kN
X-ECC MX	0.05 kN*	0.1 kN

*) eccentric loading considered

Conditions

- Fastened with X-P 20/24 G3 MX, X-P 20/24 B3 MX, X-GHP 20/24 MX, X-U 22 or X-P 22.
- Minimum 5 fastenings per fastened unit (normal weight concrete).
- All visible failures must be replaced.
- With lightweight concrete base material and appropriate washers, greater loading may be possible, please contact Hilti.
- Predominantly static loading.
- Observance of all application limitations and recommendations.

-  • For more details in relation to base material properties, please refer to the chapter **Fastener selection guide** in the Direct Fastening Manual (DFTM).

Recommended resistance under tension and shear load on steel

Designation	N_{rec}	V_{rec}
X-EHS MX	0.45 kN	0.45 kN
X-ECC MX	0.45 kN	0.45 kN

Conditions

- Fastened with X-S 14 G3 MX, X-S 14 B3 MX, X-EGN 14 or X-U 16.

Application recommendation

Base material thickness

Concrete

X-U, X-P:	$h_{min} = 80$ mm
X-P G3 MX:	$h_{min} = 60$ mm
X-P B3 MX:	$h_{min} = 60$ mm
X-GHP:	$h_{min} = 60$ mm

Steel

$t_{II} \geq 4$ mm

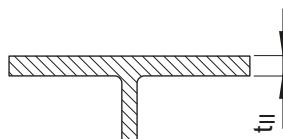

Fastener positioning

Spacing and edge distances depending on job site requirements.

Application limits

Fastening to steel

X-EGN 14, X-S 14 G3 MX, X-S 14 B3 MX

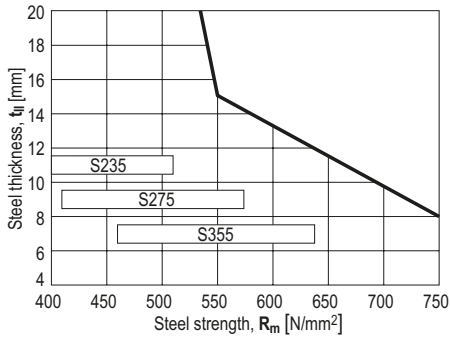

Corrosion information



- These zinc-coated fasteners are not suitable for long-term service outdoors or in otherwise corrosive environments.
- For more details, please refer to following technical document: Hilti Corrosion Handbook.

System recommendation

- For more details, please refer to the chapter **Accessories and consumables compatibility** in the Direct Fastening Technology Manual (DFTM).

Fastener selection

Designation	Shank diameter d_s	Shank length L_s	Fastener length L	Base material
X-P 20 G3 MX	3.0 mm	20 mm	21.8 mm	Concrete
X-P 24 G3 MX	3.0 mm	24 mm	25.8 mm	
X-P 20 B3 MX	3.0 mm	20 mm	21.8 mm	
X-P 24 B3 MX	3.0 mm	24 mm	25.8 mm	
X-GHP 20 MX	3.0 mm	20 mm	21.8 mm	
X-GHP 24 MX	3.0 mm	24 mm	25.8 mm	
X-P 22 MX	4.0 mm	22 mm	24.4 mm	
X-U 22 MX	4.0 mm	22 mm	24.4 mm	
X-S 14 G3 MX	3.0 mm	14 mm	15.8 mm	Steel
X-S 14 B3 MX	3.0 mm	14 mm	15.8 mm	
X-EGN 14 MX	3.0 mm	14 mm	15.8 mm	
X-U 16 MX	4.0 mm	16 mm	18.4 mm	

Cartridge recommendation

Base material	Cartridge color (tool power level)	
	Tool type: DX 6 MX DX 6 F8 Cartridge type: 6.8/11 M	Tool type: DX 6 MX, DX 5 MX, DX 460 MX, DX 351 MX DX 6 F8, DX 5 F8, DX 460 F8, DX 351, DX 2 Cartridge type: 6.8/11 M
Soft/medium concrete	titanium ■ (2-5)	yellow ■, red ■
Tough concrete	titanium ■ (4-8)	yellow ■, red ■

Cartridge recommendation

Base material		Cartridge color (tool power level)	
		Tool type: DX 6 MX	Tool type: DX 6 MX, DX 5 MX, DX 460 MX, DX 351 MX DX 6 F8, DX 5 F8, DX 460 F8, DX 351, DX 2
		DX 6 F8	
		Cartridge type: 6.8/11 M	
S235, S275, S355	$4 \leq t_{II} \leq 20 \text{ mm}$	titanium ■ (2-8)	yellow ■, red ■

-  • Tool power level adjustment by setting tests on site.
- Start tool energy selection with lowest recommended tool power level.
- Correct according requirement from chapter quality assurance.

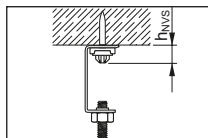
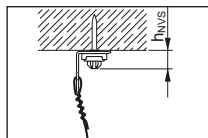
Quality assurance
X-EHS MX

 $h_{NVS} = 4-8 \text{ mm}$
X-ECC MX

 $h_{NVS} = 4-8 \text{ mm}$
Fastener program

Item no. and description

Designation	Item no.	Description
X-EHS M4 MX	273367	Threaded Rod Hanger
X-EHS M6 MX	272073	
X-EHS W6 MX	228341	
X-EHS M8 MX	273368	
X-EHS W10 MX	386468	
X-ECC MX	228342	Ceiling clip



X-DHS MX Pipe support system

Product data

Dimensions

X-DHS 3/8" MX

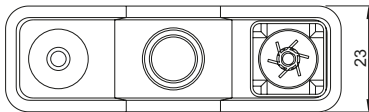
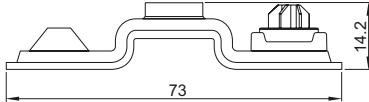

Features and benefits

- Securely fastened threaded rod hangers to steel and concrete (soft and tough) base material
- Easy installation of threaded rods on floors, walls and ceiling

General information

Material specification

X-DHS:

Zinc coating 10-20 µm

Applications

Example



Hanger system for:

- Light-duty fastenings of pipes on ceilings
- Supporting pipes on floors
- Positioning of vertical pipes on walls

These fasteners are not recommended for fastening of suspended ceilings.

These zinc coated fasteners are not suitable for long-term service outdoors or in otherwise corrosive environments.

Load data

Recommended loads (Base material = concrete)

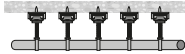
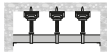
Number of X-DHS MX elements per pipe	N_{rec} [kN] per X-DHS MX
≥ 5 	0.2
1 to 4 with fixed end supports 	0.2

Design conditions:

- Each X-DHS MX element has to be fastened with 2 nails
- All visible failures must be replaced.
- Predominantly static loading.
- Valid for soft and tough concrete with strength of $f_{c, cube} = 25-60 \text{ N/mm}^2$. For more details regarding concrete types, please refer to **Concrete Fastener Selection** section in Hilti Direct Fastening Technology Manual (DFTM).
- Observance of all application limitations and recommendations.
- **For wall application (i.e. vertical pipes on walls), X-DHS MX is used for positioning purpose only, with NO imposed loading.**
- Maximum spacing = 100 cm

Recommended loads (Base material = steel)

Fastener	N_{rec} [kN]
Recommended load per X-DHS MX element (fastened with 2 Nails)	0.8

Nail recommendations

For **concrete** base material

Fastening tool	Nail types	Length [mm]	Tip	Shank Ø [mm]	Material	Hardness [HRC]	Coating [µm]
BX3	X-P B3 MX	24	Ballistic	3.0	Carbon steel	57.5	Zinc, 2-13 µm
GX3	X-P G3 MX					57.5	Zinc, 2-13 µm
GX120	X-GHP MX					57.5	Zinc, 2-13 µm

- For X-DHS MX element, only 24 mm length nails are recommended for concrete base material to ensure sufficient embedment depth.
- Premium nails (as listed above) are the only recommended nails based on intended use of X-DHS element (soft and some tough concrete, GX/BX tools). For more details regarding nail classification and concrete types, please refer to **Concrete Fastener Selection** section in Hilti Direct Fastening Technology Manual (DFTM).

For **steel** base material

Fastening tool	Nail types	Length [mm]	Tip	Shank Ø [mm]	Material	Hardness [HRC]	Coating [µm]
BX3	X-P B3 MX	17	Ballistic	3.0	Carbon steel	57.5	Zinc, 2-13 µm
GX3	X-P G3 MX	17				57.5	Zinc, 2-13 µm
GX120	X-GHP MX	18				57.5	Zinc, 2-13 µm

- For X-DHS MX element, only 17-18 mm length nails are recommended for steel base material to ensure sufficient embedment depth.

Application requirements

Thickness of base material

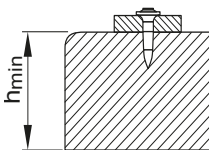

Concrete

X-GHP MX, X-P G3 MX,
X-P B3 MX

$h_{min} = 60 \text{ mm}$

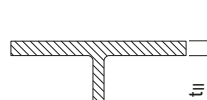

Steel

X-GHP MX, X-P G3 MX,
X-P B3 MX

$t_{II} \geq 4.0 \text{ mm}$

Application limits

X-P 17 G3 MX, X-P 17 B3 MX, X-GHP 18 MX

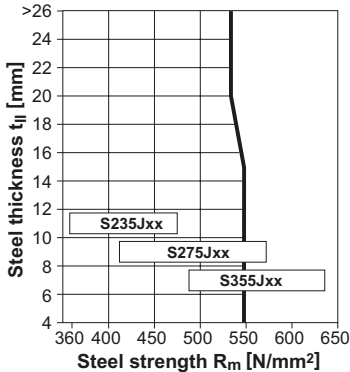

Corrosion information

These zinc-coated fasteners are not suitable for long-term service outdoors or in otherwise corrosive environments. For further detailed information on corrosion see relevant chapter in **Direct Fastening Principles and Technique** section.

Fastener selection and system recommendation

Fastener program

Designation	Item no.
X-DHS 3/8" MX	2161569

System recommendation

GX 120-ME	Gas can GC 20, GC 21 and GC 22
GX 3-ME	Gas can GC 40, GC 41 and GC 42
BX 3-ME	No gas can required

Fastening quality assurance

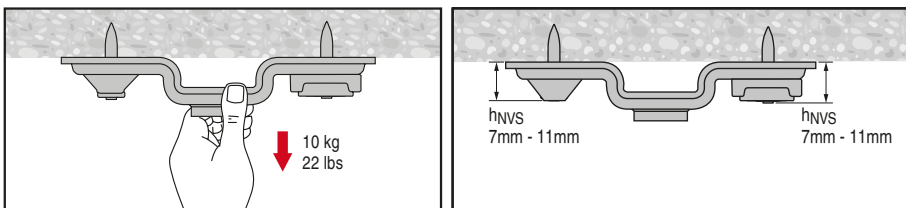

X-HS-W Wire hanging system

Product data

Dimensions

Pre assembled

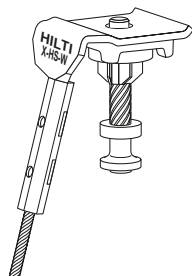

X-GHP 20/24

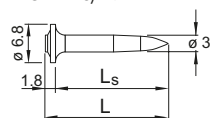

X-P 20/24 G3 MX

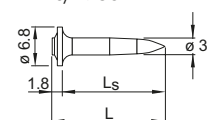

Magazined

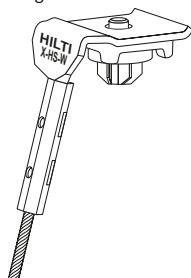

X-P 20/24 B3 MX

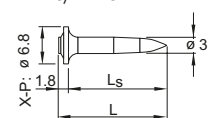

Locking Mechanism

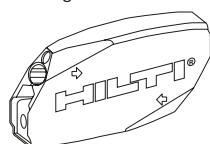

X-EGN 14

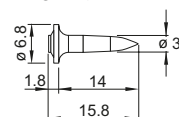

X-S 14 G3 MX

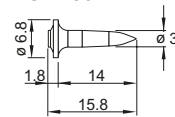

X-S 14 B3 MX

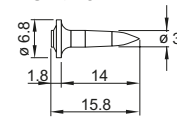

Material specifications

X-HS-W:

Zinc coating $\geq 2.5 \mu\text{m}$

Recommended fastening tools

DX 6 F8, DX 5 F8, DX 460 F8, DX 351 F8,
GX 120 ME, GX 3 ME, BX 3 ME

i • See fastener program in the next pages.

Approvals and certificates

Authority	Approval / certificate no.	Fastener	
CSTB	AT 3/09-639	X-HS-W	

i • Not all information presented in this product data sheet might be subject to approval/certificate content. Please refer to approval/certificate for further information.

Applications

Examples



Round Air Ducts



Square Air Ducts



Light weight Cable Trays /
Lights

Performance data

Recommended resistance under tension and shear load

DX Standard for concrete

Designation	N_{rec}	V_{rec}	h_{ET}
X-HS-W U27	0.20 kN	0.3 kN	22 mm
X-HS-W U22	0.15 kN	0.2 kN	18 mm
X-HS-W MX with X-P 20/24 G3 MX, X-P 20/24 B3 MX, X-GHP 20/24 MX	0.05 kN	0.1 kN	14 mm

Conditions

- Minimum 5 fastenings per fastened unit (normal weight concrete).
- All visible failures must be replaced.
- Predominantly static loading.
- Observance of all application limitations and recommendations.

DX Standard for steel

Fastener designation	N_{rec}	V_{rec}
X-HS-W U16	0.90 kN	0.90 kN
X-HS-W MX with X-S 14 G3 MX, X-S 14 B3 MX, X-EGN 14 MX	0.45 kN	0.45 kN

Conditions

- Predominantly static loading.
- Observance of all application limitations and recommendations.



- For more details in relation to base material properties, please refer to the chapter **Fastener selection guide** in the Direct Fastening Manual (DFTM).

Application recommendation

Base material thickness

Concrete

X-U:	$h_{\min} = 80 \text{ mm}$
X-P G3 MX:	$h_{\min} = 60 \text{ mm}$
X-P B3 MX:	$h_{\min} = 60 \text{ mm}$
X-GHP MX:	$h_{\min} = 60 \text{ mm}$

Steel

$t_{II} \geq 4 \text{ mm}$

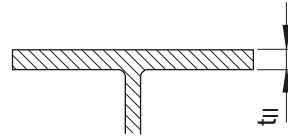

Fastener positioning in base material

Spacing and edge distances depending on job site requirements.

Application limits

Steel

X-HS-W MX with X-S 14 G3 MX, X-S 14 B3 MX, X-EGN 14 MX

X-HS-W U16 P8

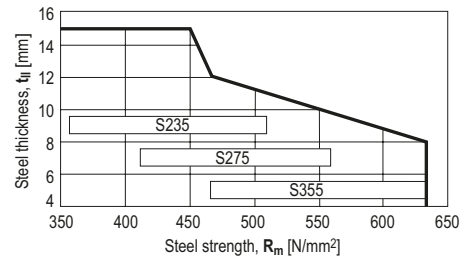
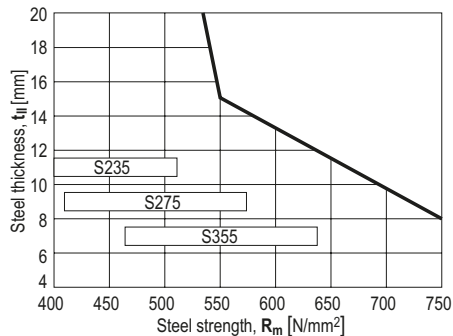

Corrosion information



- These zinc-coated fasteners are not suitable for long-term service outdoors or in otherwise corrosive environments.
- For more details, please refer to following technical document: Hilti Corrosion Handbook.

System recommendation

- For more details, please refer to the chapter **Accessories and consumables compatibility** in the Direct Fastening Technology Manual (DFTM).

Cartridge recommendation for fastening on concrete

Base material	Cartridge color (tool power level)	
	Tool type: DX 6 F8	Tool type: DX 5 F8, DX 460 F8, DX 351 F8, DX 2
	Cartridge type: 6.8/11 M	Cartridge type: 6.8/11 M
Soft/medium concrete	titanium ■ (1-5)	green ■, yellow ■
Tough concrete	titanium ■ (4-8)	yellow ■, red ■

Cartridge recommendation for fastening on steel

Base material	Cartridge color (tool power level)	
	Tool type: DX 6 F8	Tool type: DX 5 F8, DX 460 F8, DX 351, DX 2
	Cartridge type: 6.8/11 M	Cartridge type: 6.8/11 M
S235, S275, S355	$4 \leq t_{II} \leq 15 \text{ mm}$ titanium ■ (2-8)	yellow ■, red ■

- Tool power level adjustment by setting tests on site.
- Start tool energy selection with lowest recommended tool power level.
- Correct according requirement from chapter quality assurance.

Quality assurance

X-HS-W

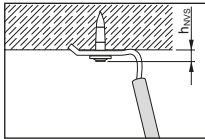

$h_{NVS} = 5.5\text{--}8.5\text{ mm}$



- No lifting: do not use for lifting, such as in a crane or pulley situation.
- No movement: Hilti hangers are to be used to suspend stationary loads only. Do not use to suspend moving services, or services likely to be subject to movement.
- No joining: Hilti hangers must not be used as an in-line joint using a Hilti fastener, or any other joining device. A Hilti hanger assembly must comprise one length of cable and one Hilti fastener only. If a longer length is needed, do not join two assemblies together.

Fastener program

Item no. and description

Designation	Item no.	Description
X-HS-W U16 P8 1m/3ft	387430	For DX tools
X-HS-W U22 P8 1m/3ft	387431	
X-HS-W U27 P8 1m/3ft	387432	
X-HS-W U16 P8 2m/7ft	387919	
X-HS-W U22 P8 2m/7ft	387920	
X-HS-W U27 P8 2m/7ft	387921	
X-HS-W U16 P8 3m/10ft	387433	
X-HS-W U22 P8 3m/10ft	387434	
X-HS-W U27 P8 3m/10ft	387435	
X-HS-W MX 1m/3ft	387436	For GX tools and BX tools
X-HS-W MX 2m/7ft	387922	
X-HS-W MX 3m/10ft	387437	

X-EKB, X-ECH Electrical fastener

Product data

Dimensions

Single fastener

X-EKB 8/4-FR

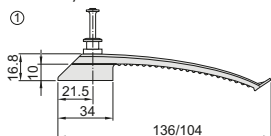

X-EKB 16 (FR)

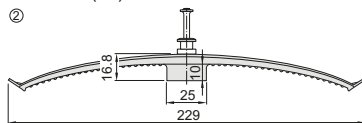

X-U 37 PH

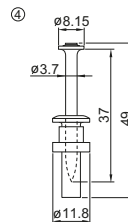

X-ECH-S (FR)

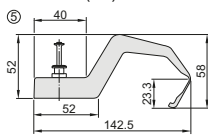

X-ECH-M (FR)

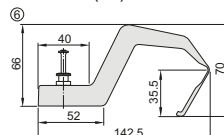

X-ECH-L (FR)

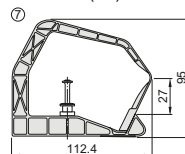

Magazine fastener

X-EKB 4 / 8 / 16 MX (FR)



X-EKB 4 MX (FR)

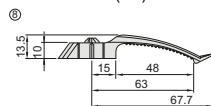

X-ECH-B MX

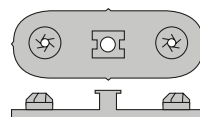

X-ECH-15/30 MX

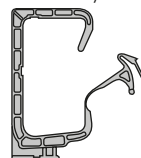

X-GHP 20/24

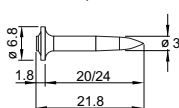

X-GN 27

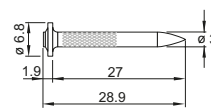

X-EGN 14

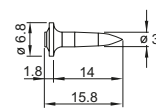

X-U 16/22/27

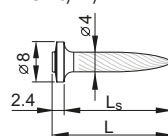

X-P 20/24 G3 MX

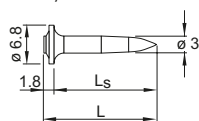

X-C 27 G3 MX

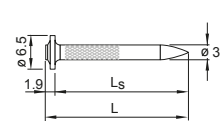

X-S 14 G3 MX

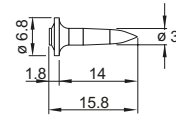

X-P 22

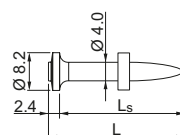

X-P 20/24 B3 MX

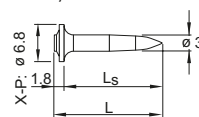

X-S 14 B3 MX

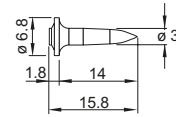

Material specifications

- See fastener program in the next pages.

Recommended fastening tools

DX 6 MX, DX 5 MX, DX 460 MX, DX 351 MX,
DX 6 F8, DX 5 F8, DX 460-F8, DX 351 F8, DX 36, DX 2,
GX 120 ME, GX 3 ME, BX 3 ME

- See fastener program in the next pages.

Approvals and certificates

UL (USA): X-EKB MX, X-ECH / FR_U37

CSTB (France): X-EKB_U 37, X-ECH_U37

- Not all information presented in this product data sheet might be subject to approval / certificate content. Please refer to approval / certificate for further information.

Applications

Examples

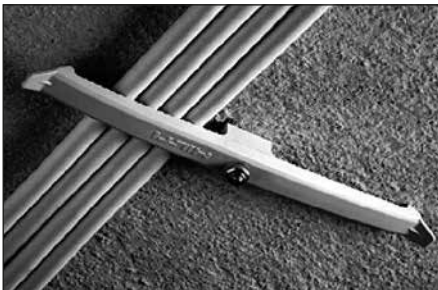

X-EKB for fastening cables



X-ECH for fastening bunched cables

Performance data

Fastener capacity for X-EKB: Securing electrical cables to concrete ceilings and walls

Designation	Number of wires/cables and wire sizes	
	NYM 3 x 1.5 mm ² (Ø 8 mm)	NYM 5 x 1.5 mm ² (Ø 10 mm)
X-EKB 4 __	4	3
X-EKB 8 __	8	5
X-EKB 16 __	16	10

- Max. capacity (number of cables in one X-EKB) at spacing of 50–100 cm.

Fastener capacity for X-ECH: Securing electrical cable to ceilings and walls

Designation	No. of nails	Number of cables
X-ECH-S ___ and X-ECH/FR-S ___		max. 15 NYM 5x1.5 ² (Ø 10 mm)
X-ECH-M ___ and X-ECH/FR-M ___		max. 25 NYM 5x1.5 ² (Ø 10 mm)
X-ECH-L ___ and X-ECH/FR-L ___		max. 35 NYM 5x1.5 ² (Ø 10 mm)
X-ECH-15 MX and X-ECH-B	1 or 2	max. 15 NYM 3x1.5 ² (Ø 10 mm)
X-ECH-30 MX and X-ECH-B	1 or 2	max. 30 NYM 3x1.5 ² (Ø 10 mm)

Conditions

- Max. capacity at spacing of 60–80 cm.
- For concrete C12/15 to C45/55 ($f_{cc} = 15$ to 55 N/mm²)
- All visible placing failures have to be replaced
- Damaged X-ECH have to be replaced



- For more details in relation to base material properties, please refer to the chapter **Fastener selection guide** in the Direct Fastening Manual (DFTM).

Application recommendation
Base material thickness
Concrete

X-U, X-P:	$h_{min} = 80$ mm
X-P G3 MX:	$h_{min} = 60$ mm
X-P B3 MX:	$h_{min} = 60$ mm
X-GHP MX, X-GN MX:	$h_{min} = 60$ mm

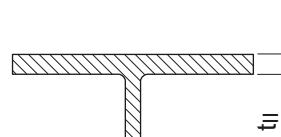
Steel
 $t_{fl} \geq 4$ mm

Fastened material thickness

- Fasteners recommended for cable Ø 8 mm and 10 mm.

Spacing and edge distances

X-EKB:	approximately 50–100 cm	(Adjust as necessary to control cable sag)
X-ECH:	approximately 60– 80 cm	(Adjust as necessary to limit sagging)

Corrosion information

- These zinc-coated fasteners are not suitable for long-term service outdoors or in otherwise corrosive environments.
- For more details, please refer to following technical document: Hilti Corrosion Handbook.

System recommendation

- For more details, please refer to the chapter **Accessories and consumables compatibility** in the Direct Fastening Technology Manual (DFTM).

Cartridge recommendation for fastening on concrete

Base material	Cartridge color (tool power level)	
	Tool type: DX 6 MX DX 6 F8	Tool type: DX 5 MX, DX 460 MX, DX 351 MX DX 5 F8, DX 460 F8, DX 351, DX 2
	Cartridge type: 6.8/11 M	Cartridge type: 6.8/11 M
Soft/medium concrete	titanium ■ (2-5)	yellow ■, red ■
Tough concrete	titanium ■ (4-8)	yellow ■, red ■

Cartridge recommendation for fastening on steel

Base material	Cartridge color (tool power level)	
	Tool type: DX 6 MX DX 6 F8	Tool type: DX 5 MX, DX 460 MX DX 5 F8, DX 460 F8, DX 351, DX 2
	Cartridge type: 6.8/11 M	Cartridge type: 6.8/11 M
S235, S275, S355	$4 \leq t_{II} \leq 20 \text{ mm}$ titanium ■ (4-8)	red ■

- Tool power level adjustment by setting tests on site.
- Start tool energy selection with lowest recommended tool power level.
- Correct according requirement from chapter quality assurance.

Quality assurance

X-EKB fastening quality

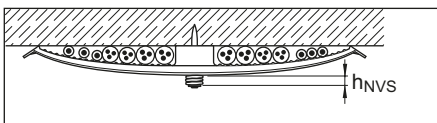

$$h_{NVS} = 7 \pm 2 \text{ mm}$$

X-ECH fastening quality

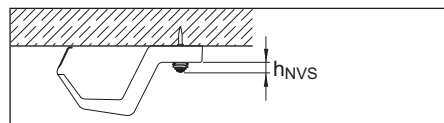

$$h_{NVS} = 7 \pm 2 \text{ mm}$$

Fastener program
Fastener with pre-mounted DX-nail: Technical information

	Designation	Shank Ø d _s	Shank length L _s	Tools
①	X-EKB8 U 37	4.0 mm	37 mm	DX 6 F8, DX 5 F8, DX460 F8, DX351 F8, DX36, DX 2
②	X-EKB16 U 37	4.0 mm	37 mm	
⑤	X-ECH-S U 37	4.0 mm	37 mm	
⑥	X-ECH-M U 37	4.0 mm	37 mm	
⑦	X-ECH-L U 37	4.0 mm	37 mm	
①	X-EKB4-FR U 37	4.0 mm	37 mm	
①	X-EKB8-FR U 37	4.0 mm	37 mm	
②	X-EKB16-FR U 37	4.0 mm	37 mm	
⑤	X-ECH/FR-S U 37	4.0 mm	37 mm	
⑥	X-ECH/FR-M U 37	4.0 mm	37 mm	
⑦	X-ECH/FR-L U 37	4.0 mm	37 mm	

- ③, ④ All nail shanks: carbon steel, HRC 58, galvanized 2–20 µm
 Sleeve/thimble: carbon steel, not hardened, galvanized 5–13 µm
- ⑩–Δ See Product data in previous pages

Fastener with pre-mounted DX-nail: Order information

Designation	Item no.	Plastic material
X-EKB 4-FR U37	361581	Polyamide (PA) ²⁾
X-EKB 8 U37	386231	Polyamide (PA) ¹⁾
X-EKB 8-FR U37	386233	Polyamide (PA) ²⁾
X-EKB 16 U37	386232	Polyamide (PA) ¹⁾
X-EKB 16-FR U37	386234	Polyamide (PA) ²⁾
X-ECH-S U37	386235	Polyamide (PA) ¹⁾
X-ECH-M U37	386236	Polyamide (PA) ¹⁾
X-ECH-L U37	386237	Polyamide (PA) ¹⁾
X-ECH/FR-S U37	386238	Polyamide (PA) ²⁾
X-ECH/FR-M U37	386239	Polyamide (PA) ²⁾
X-ECH/FR-L U37	386240	Polyamide (PA) ²⁾

¹⁾ halogen and silicone free, light grey (RAL 7035)

²⁾ halogen and silicone free, flame retardant, stone grey (RAL 7030)

Fastener without pre-mounted nail: Technical information

Base material	Cable Holder	Fastening Technology	Nail
Concrete	X-EKB 4 MX X-EKB 8 MX X-EKB 16 MX X-EKB 4 FR MX X-EKB 8 FR MX X-EKB 16 FR MX	GX	X-P 20/24 G3 MX
		GX	X-C 27 G3 MX
		GX	X-GHP 20/24 MX
		GX	X-GN 27 MX
		BX	X-P 20/24 B3 MX
		DX	X-U 22/27 MX
		DX	X-P 22/27 MX
Steel	X-ECH-15 MX* X-ECH-30 MX*	GX	X-S 14 G3 MX
		GX	X-EGN 14 MX
		BX	X-S 14 B3 MX
		DX	X-U 16 MX

* To be used with GX or BX technology ONLY

Fastener without pre-mounted nail: Order information

Designation	Item no.	Plastic material	Description
X-EKB 4 MX	285712	Polyamide (PA) ¹⁾	Electrical Cable Holder
X-EKB 8 MX	285713	Polyamide (PA) ¹⁾	
X-EKB 16 MX	285714	Polyamide (PA) ¹⁾	
X-EKB 4 FR MX	285715	Polybutylenterephthalate (PBT) ²⁾	
X-EKB 8 FR MX	285716	Polybutylenterephthalate (PBT) ²⁾	
X-EKB 16 FR MX	285717	Polybutylenterephthalate (PBT) ²⁾	
X-ECH-15 MX	2018247	Polyamide (PA) ³⁾	
X-ECH-30 MX	2018248	Polyamide (PA) ³⁾	
X-ECH-15/B MX	2018729 (kit)	Polyamide (PA) ³⁾	
X-ECH-30/B MX	2018891 (kit)	Polyamide (PA) ³⁾	
X-ECH-B MX	2018391	Polyamide (PA) ³⁾	

¹⁾ halogen free, light grey (RAL 7035)

²⁾ silicone free, stone grey (RAL 7030)

³⁾ halogen and silicone free, light grey (RAL 7035)

X-DFC Double fire clip

Product data

Dimensions

X-DFC 8 MX / X-DFC-W 8 MX

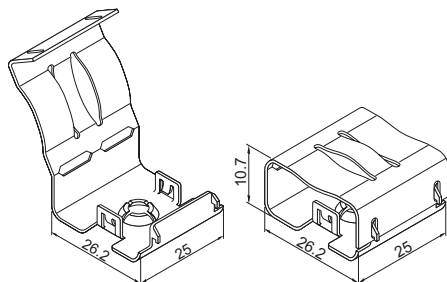

X-DFC 9 MX / X-DFC-W 9 MX

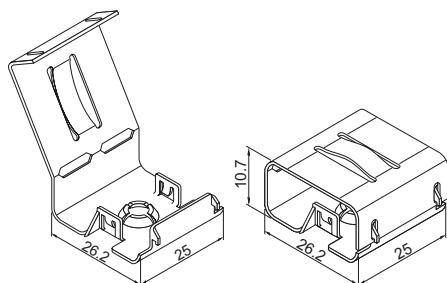

Features and benefits

- Easy and convenient installation to concrete (soft and some tough) and sandlime stone base material
- Quick, cost-efficient fastening
- Can be clicked on BX fastener guide, no adaptor needed
- Tested by an external, certified test institute

General information

Material specifications

X-DFC-MX: Stainless steel with 50 µm red or white colour coating

Approval and standards

Product qualification according to BS EN 50200, BS EN 50200 Annex E and BS 8434-2

In compliance with cable support requirements of BS 5839-1, BS 5839-8 and BS 5266-1

Applications

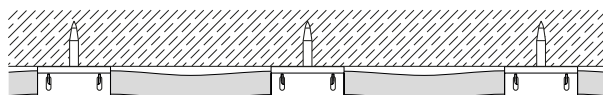

Installation of fire alarm and emergency lighting cables.

Performance data

Fire rating

Cable	Fastener	Cable size	Classification	Test standard
Prysmian FP200 Gold (standard)	X-DFC 8 MX / X-DFC-W 8 MX	2 core x 1.5 mm ² 3 core x 1.5 mm ²	PH 60	BS EN 50200 (dry)
			PH 30	BS EN 50200 Annex E (wet)
Prysmian FP plus (enhanced)	X-DFC 9 MX / X-DFC-W 9 MX	2 core x 1.5 mm ²	PH 120	BS EN 50200 (dry) BS 8434-2 (wet)
Ventcroft NoBurn Platinum (standard)	X-DFC 8 MX / X-DFC-W 8 MX	2 core x 1.5 mm ² 4 core x 1.0 mm ²	PH 60	BS EN 50200 (dry)
			PH 30	BS EN 50200 Annex E (wet)
	X-DFC 9 MX / X-DFC-W 9 MX	2 core x 2.5 mm ² 4 core x 1.5 mm ²	PH 60	BS EN 50200 (dry)
			PH 30	BS EN 50200 Annex E (wet)
Ventcroft NoBurn plus (enhanced)	X-DFC 8 MX / X-DFC-W 8 MX	2 core x 1.5 mm ²	PH 120	BS EN 50200 (dry) BS 8434-2 (wet)

Conditions:

- Pre-loading of the elements after setting
- All visible failures must be replaced.
- Observance of all application limitations and recommendations.

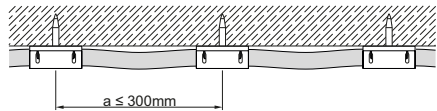

Recommended fastener spacing a:
horizontal ≤ 300 mm, vertical ≤ 400 mm

Fastener selection and system recommendation

Fastener program

Designation	Item no.	Colour	Cable diameter
X-DFC 8 MX	2143695	Red	8 mm $\leq D \leq 8.5$ mm
X-DF-W 8 MX	2143699	White	
X-DFC 9 MX	2143696	Red	8.5 mm $\leq D \leq 9$ mm
X-DFC-W 9 MX	2143730	White	

Tool selection

X-P B3 MX: BX 3-ME No gas can required
 X-P G3 MX: GX 3-ME Gas can GC 40, GC 41 and GC 42

Nail recommendation

Fastening tool	Nail types	Length [mm]	Tip	Shank Ø [mm]	Material	Hardness [HRC]	Coating [µm]
BX3-ME	X-P B3 MX	17 - 20	Long-conical	3.0	Carbon steel	57.5	Zinc, 2-13
GX3-ME	X-P G3 MX					57.5	Zinc, 2-13

- For the X-DFC MX element, only 17 mm and 20 mm pin lengths are recommended in order to ensure sufficient embedment depth.
- Nails (as listed above) are recommended for wall and ceiling application (soft and some tough concrete and sandlime stone, GX/BX tools). For more details regarding nail classification and concrete types, see Concrete Fastener Selection chapter in Direct Fastening Technology Manual (DFTM).

Application requirements

Thickness of base material



Edge distance

Min. edge distance = 70 mm

Corrosion information

Zinc-coated nails are not suitable for long-term service outdoors or in otherwise corrosive environments. For further detailed information on corrosion see relevant chapter in Direct Fastening Principles and Technique section.

Fastening quality assurance

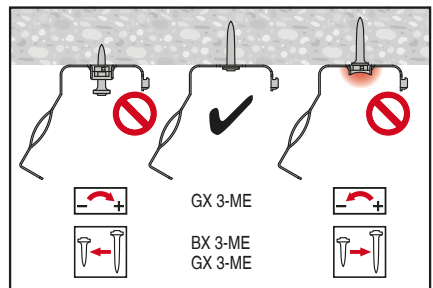
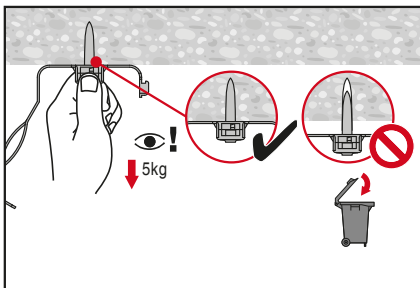

X-MCT-FE MX Metal cable tie holder

Product data

Wiring system

Cable tie holder
X-MCT-FE MX



Cable tie

Metal cable tie
Plastic cable tie

Features and benefits

- Maintaining function of the fastener during fire
- Magnetic interface
- Bi-direction cable tying
- Fire test method following BS 7671
- Testing acc. to EN 1363-1: 2020-05

Environmental condition



Dry Indoor

Dimension

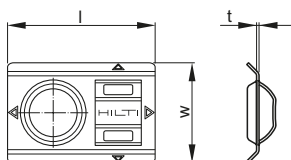

Width of the cable tie holder	Length of the cable tie holder	Thickness cable tie holder	Admissible cable tie width	
w	l	t	w _{min}	w _{max}
32.5 mm	48 mm	0.8 mm	4.9 mm	8 mm

w_{min} is based on testing requirements

Material specification and material properties

Item no.	Element	Material	Coating	Process	Minimum coating thickness
2276133	X-MCT-FE MX	DX51 D	zinc	Pre-galvanizing	5 µm

Corrosion resistance

For fastenings not directly exposed to external weather conditions or moist atmosphere.

Base material

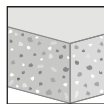

Soft concrete

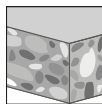

Tough concrete

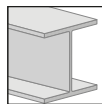

Steel

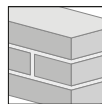

Masonry Solid brick



Static/
quasi static



Fire resistance

Load condition

Application

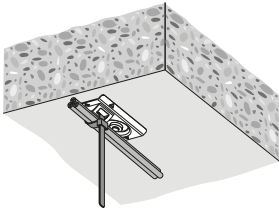

Fastening electrical installation to ceiling and wall

Admissible electrical installation

Electrical installations General cables

Load data

Recommended resistance under tension and shear load for fastening on soft and tough concrete and steel based on working load concept

Wiring system	Tension load N_{rec}	Shear load V_{rec}	Fire rating cable tie holder	Fire rating cable tie
X-MCT-FE MX	0.04 kN	0.04 kN	120 min.	Utilization of suitable cable tie acc. to national standards

Fastening quality assurance

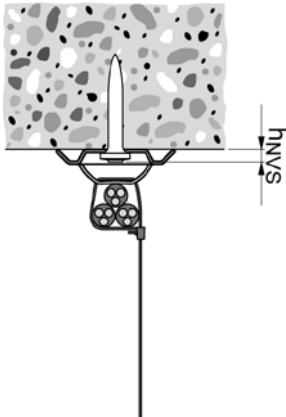

Admissible fastener stand-off

$$h_{NVS, \min} = 5 \text{ mm}$$

$$h_{NVS, \max} = 11 \text{ mm}$$

System recommendation

Wiring system mounted with battery-actuated fastener

Element	Fastener						Battery-actuated tool	Base material			
	X-P 17 B3 MX	X-P 20 B3 MX	X-P 24 B3 MX	X-C 20 B3 MX	X-C 24 B3 MX	X-S 14 B3 MX		Soft concrete	Tough concrete	Steel	Masonry Solid brick
Name	X-P 17 B3 MX	X-P 20 B3 MX	X-P 24 B3 MX	X-C 20 B3 MX	X-C 24 B3 MX	X-S 14 B3 MX	BX 3-ME	Soft concrete	Tough concrete	Steel	Masonry Solid brick
X-MCT-FE MX	■	■					■	■	■		■
X-MCT-FE MX			■	■	■		■	■			■
X-MCT-FE MX						■	■			■	

■ recommended

Setting information

- Fastener setting information (e. g. base material properties, fastened material properties and setting energy) is part of the corresponding Product Data Sheet for fastener.
- Fastener guide X-GF B3-FG required for fastener setting with battery-actuated tool.



X-MCT MX Metal cable tie holder

Product data

Product description

X-MCT MX



- Maintaining function of the fastener during fire
- Bi-direction cable tying
- Classification of Hilti X-MCT-MX cable tie holder in accordance with AS/NZS 3013 – 2015, Appendix C

Dimensions

Technical drawing	Designation	Width	Length	Thickness	Admissible tie width	
		w	l	t	w _{min}	w _{max}
	X-MCT MX	32.4 mm	44 mm	1 mm	4.9 mm	8 mm

• w_{min} is based on testing requirements.

Material specification and material properties for carbon steel elements

Designation	Element	Material	Coating	Process	Minimum coating thickness
X-MCT MX	Cable tie holder	DX51D	Zinc	Pre-galvanizing	5 µm

Applications

Fastening electrical installation to ceiling

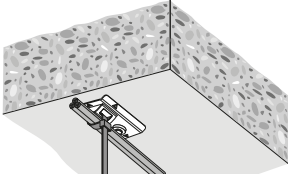

Admissible electrical installation

Electrical installations

- General cables
- Flame retardant cables
- Fire rated cables in accordance with Australian standards

Base materials

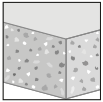

Soft
concrete

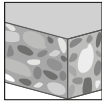

Tough
concrete

Load conditions



Static/
quasi static



Fire rated

Environmental conditions



Dry indoor

- For more details, please refer to following technical document:
Hilti Corrosion Handbook.

Approvals/certificates

Authority	Approval/certificate no.	Date of issue	Country of issue
CSIRO	FCO-3417	03/2021	Australia

- Not all information presented in this product data sheet might be subject to approval/certificate content. Please refer to approval/certificate for further information.

Performance data

Recommended resistance under tension and shear load

Designation	Tension load N_{rec}	Shear load V_{rec}	Fire rated
X-MCT MX	0.02 kN	0.02 kN	120 min.

- Utilization of suitable cable tie acc. to national standards.
- Redundancy of fastening points is required.
- Minimum number of fastening points for safety relevant fastenings: ≥ 5 .

System recommendation

- For more details, please refer to the chapter **Accessories and consumables compatibility** in the Direct Fastening Technology Manual (DFTM).

Wiring system mounted with battery-actuated fastener

Element designation	Fastener designation				Battery-actuated tool				Base material	
	X-P 17 B3 MX	X-P 20 B3 MX	X-P 24 B3 MX		BX 3 ME				Soft concrete	Tough concrete
X-MCT MX	■	■			■				■	■
X-MCT MX			■		■				■	

■ = recommended

Wiring system mounted with gas-actuated fastener

Element designation	Fastener designation					Gas-actuated tool				Base material	
	X-P 17 G3 MX	X-P 20 G3 MX	X-P 24 G3 MX	X-GHP 18 MX	X-GHP 20 MX	GX 3 ME	GX 120 ME			Soft concrete	Tough concrete
X-MCT MX	■	■				■				■	■
X-MCT MX			■			■				■	
X-MCT MX				■			■			■	■
X-MCT MX					■		■			■	

■ = recommended

Wiring system mounted with powder-actuated collated fastener

Element designation	Fastener designation					Powder-actuated tool				Base material	
	X-P 22 MX	X-P 27 MX				DX 6 MX	DX 5 MX	DX 460 MX	DX 351 DX	Soft concrete	Tough concrete
X-MCT MX	■	■				■	■	■	■	■	■

■ = recommended

Wiring system mounted with powder-actuated single fastener

Element designation	Fastener designation					Powder-actuated tool				Base material	
	X-P 22 P8	X-P 27 P8				DX 6 F8	DX 5 F8	DX 460 F8	DX 351 CT	Soft concrete	Tough concrete
X-MCT MX	■	■				■	■	■	■	■	■

■ = recommended

Setting information

- Fastener setting information (e.g. base material properties, fastener material properties and setting energy) is part of the corresponding product data sheet for fastener.

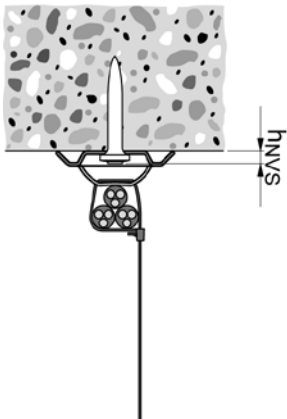
Quality assurance
Setting depth control

Admissible fastener stand-off

$$h_{NVS, \min} = 4 \text{ mm}$$

$$h_{NVS, \max} = 11 \text{ mm}$$

- Visible setting failures must be replaced with a new fastener, not in the same hole.
- These are abbreviated instructions which may vary by application.
- Always review / follow the instructions accompanying the product.

Performance data

Designation	Item no.	Description
X-MCT MX	2276132	Metal cable tie holder

X-ECH-FE MX, X-EKB-FE MX Circuit integrity fastener

Product data

Dimensions

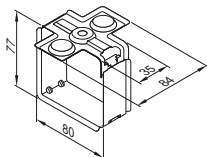
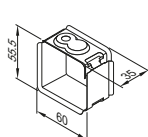
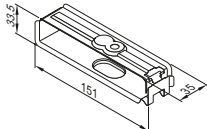
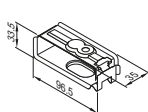
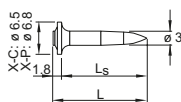
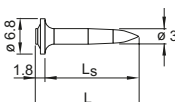
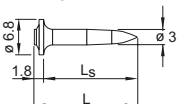
X-ECH-FE 30 MX

X-ECH-FE 15 MX

X-EKB-FE 15 MX

X-EKB-FE 8 MX

X-P 17 B3 MX

X-GHP 18 MX

X-P 17 G3 MX

General information

Material specifications

Galvanized steel sheet	≥ 5 µm zinc coating
X-GHP	Carbon steel, HRC 57.5, zinc coating 2-10 µm
X-P G3 MX	Carbon steel, HRC 57.5, zinc coating 2-10 µm
X-P B3 MX	Carbon steel, HRC 57.5, zinc coating 2-10 µm

Recommended fastening tools

GX 120-ME, GX 3-ME, BX 3-ME

Approval

AbP P-MPA-E-16-010
 AbP P-2401/198/16-MPA BS
 AbP P-1023 DMT DO

Expert review on MLAR application by MPA IBMB Braunschweig

Expert review on nail load in circuit integrity applications by MPA IBMB Braunschweig

Applications



Circuit integrity system (CIS) application with fire rating and load data according to **AbP**

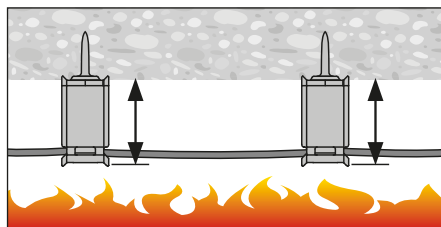

Application to non-circuit integrity cables in escape routes (according to **MLAR**)

Load Data
Recommended loads (ceiling and wall application)

Application →	Escape routes (MLAR)		Circuit integrity system		Spacing a [mm]
	Fastener ↓	Load N_{rec} [kN]	Fire Rating	Cable weight [kg/m]	
X-ECH-FE 30 MX	0.04*	F90	According to AbP documents, fire rating (E30 - E90) and cable weights specific to combination of:	-	$a \leq 600$ mm
X-ECH-FE 15 MX	0.02**				
X-EKB-FE 15 MX	0.02**				
X-EKB-FE 8 MX	0.02**				

* 6.6 kg/m with spacing $a = 600$ mm

** 3.3 kg/m with spacing $a = 600$ mm

- Pre-loading of the elements with load $\geq N_{rec}$ after setting
- All visible failures must be replaced (see “Fastening quality assurance”)

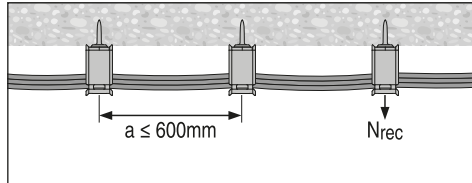
Fastener selection and system recommendation
Thickness of base material

Corrosion Information

The intended use only comprises fastenings which are not directly exposed to external weather conditions or moist atmospheres.

Application requirements
Fastener program

Designation	Item no.
X-ECH-FE 30 MX	2142822
X-ECH-FE 15 MX	2142823
X-EKB-FE 15 MX	2142824
X-EKB-FE 8 MX	2142825

Fastener program

Base material	Nail designation	Shank length Ls [mm]	Nail length L [mm]	Tool
Concrete	X-GHP 18 MX	18	19.8	GX 120-ME
	X-P 17 G3 MX	17	18.8	GX 3-ME
	X-P 17 B3 MX	17	18.8	BX 3-ME

System recommendation

GX 120-ME	Gas can GC 20, GC 21 and GC 22
GX 3-ME	Gas can GC 40, GC 41 and GC 42
BX 3-ME	No gas can required

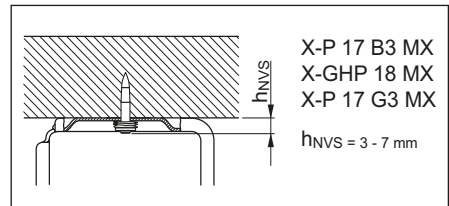
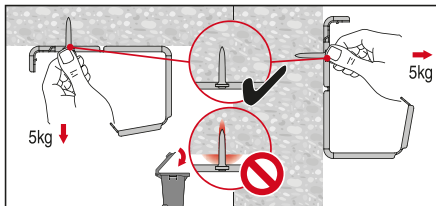
Fastening quality assurance



X-EAS-FE MX Stand-off single cable holder

Designation

X	-	EAS-FE	6-10	MX
Technology		Application	Cable diameter	Fastening type

Technology:

X | DX solution

Application:

EAS-FE | Stand-off single cable holder

Cable diameter:

6 | Minimum admissible cable diameter
 10 | Maximum admissible cable diameter

Fastening type:

MX | Collated fastening

Product data

Product description

X-EAS-FE MX (Type 1)



X-EAS-FE MX (Type 2)



- X-EAS-FE MX fastening system for securing circuit integrity and operability of electrical circuits during fire.
- Approved fire resistance according to DIN 4102-12.
- Easy assembling.
- Compatible with magnetic tool interface.

Fastening system

Designation		Battery-actuated fastener		
		X-P 17 B3 MX	X-P 20 B3 MX	X-P 24 B3 MX
X-EAS-FE 6-10 MX	Type 1			
X-EAS-FE 11-14 MX		●	●	●
X-EAS-FE 15-19 MX				
X-EAS-FE 20-25 MX	Type 2	●	●	●
X-EAS-FE 26-31 MX				

Dimensions for cable holders

	Designation	Width	Length	Thickness	Height
		w	l	t ₁ /t ₂	h
	6-10 MX	40 mm	72 mm	0.8/1.2 mm	28 mm
	11-14 MX	44 mm	72 mm	0.8/1.2 mm	30 mm
	15-19 MX	48 mm	72 mm	0.8/1.2 mm	35 mm

	Designation	Width	Length	Thickness	Height
		w	l	t	h
	20-25 MX	52 mm	65 mm	1 mm	48 mm
	26-31 MX	57 mm	65 mm	1 mm	52 mm

Material specification and material properties for steel elements

Designation	Element	Material	Coating	Minimum coating thickness
X-EAS-FE MX (Type 1, 2)	Cable holder	SPCC	Zinc	5 µm



- SPCC = Cold rolled steel sheet
- Info for nails and anchors are part of the corresponding Product Data Sheets.

Approvals and certificates

Authority	Approval/certificate no.	Date of issue	Description
MPA IBMB Braunschweig	2401/462/21	06/2021	Expert opinion norm construction
	P-2401/468/21-MPA BS	07/2021	CIS test certificate (abP)

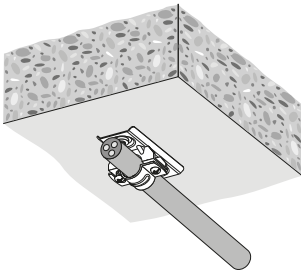

- Not all information presented in this product data sheet might be subject to approval/certificate content. Please refer to approval/certificate for further information.

Applications

Fastening (Type 1)

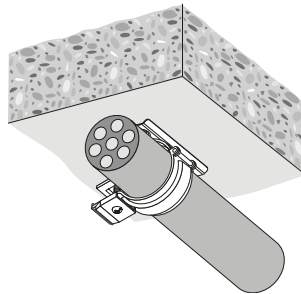

Fastening (Type 2)

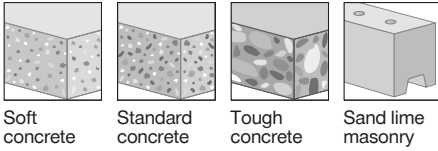
Base materials

Soft concrete

Standard concrete

Tough concrete

Sand lime masonry

Load conditions
Static/
quasi static

Fire resistance

Environmental conditions

		Designation		
Environmental condition		X-EAS-FE MX (Type 1, 2) combined with X-P 17 B3 MX	X-EAS-FE MX (Type 1, 2) combined with X-P 20 B3 MX	X-EAS-FE MX (Type 1, 2) combined with X-P 24 B3 MX
	Dry indoor	■	■	■

■ = suitable for corrosion protection



• For more details, please refer to following technical document: Hilti Corrosion Handbook.

Fastener program
Item no. and description

Designation	Item no.	Description
X-EAS-FE 6-10 MX	2325722	Cable holder
X-EAS-FE 11-14 MX	2325723	
X-EAS-FE 15-19 MX	2325724	
X-EAS-FE 20-25 MX	2325725	
X-EAS-FE 26-31 MX	2325726	
X-P 17 B3 MX	2156216	Fastener
X-P 20 B3 MX	2156217	
X-P 24 B3 MX	2156218	
X-FG B3-ME	2101258	Fastener guide
X-FG B3-FE	2208570	Magnetic fastener guide

X-EAS-FE MX – Fastening electrical installation

Application recommendation

Fastened material dimensions

Designation	1 cable		2 cables		3 cables	
	Ø min	Ø max	Ø min	Ø max	Ø min	Ø max
X-EAS-FE 6-10 MX	6 mm	10 mm	3 mm	5 mm	3 mm	5 mm
X-EAS-FE 11-14 MX	11 mm	14 mm	6 mm	7 mm	5 mm	6 mm
X-EAS-FE 15-19 MX	15 mm	19 mm	8 mm	9 mm	7 mm	8 mm
X-EAS-FE 20-25 MX	20 mm	25 mm	10 mm	12 mm	9 mm	11 mm
X-EAS-FE 26-32 MX	26 mm	32 mm	13 mm	16 mm	12 mm	14 mm

Tested configurations for norm-/standard configuration according to DIN 4102-12

Cable manufacturer	VDE Nr.	Cable type		Cable dimension	Clip type	Spacing	Cable per clip	Classification
Dätwyler KERAM	7780	(N)HXCH FE 180 E90		n x 1.5/1.5- n x 35/16	X-EAS-FE _- MX	30 cm	1	E30 - E90
Dätwyler KERAM	7780	(N)HXH FE 180 E90		n x 1.5- n x 35	X-EAS-FE _- MX	30 cm	1	E30 - E90
Eupen EUCASAFE	6563	JE-H(ST)H...Bd FE 180 E90		n x 2 x 0.8	X-EAS-FE _- MX	30 cm	1	E30 - E90

Cable specific constructions according to DIN 4102-12

Cable manufacturer	VDE Nr.	Cable type	Number of pairs (n)	Number of cores (n)	Cable dimension	Clip type	Spacing	Cable per clip	Classification
Dätwyler KERAM	9361	JE-H(S)H FE 180 E30 - E90	2	2	n x 2 x 0.8	X-EAS-FE 11-14 MX	30 cm	2	E30 - E60
Dätwyler KERAM	9361	JE-H(S)H FE 180 E30 - E90	4	2	n x 2 x 0.8	X-EAS-FE 15-19 MX	30 cm	2	E30 - E60
Dätwyler KERAM	9361	JE-H(S)H FE 180 E30 - E90	8; 12	2	n x 2 x 0.8	X-EAS-FE 26-31 MX	30 cm	2	E30 - E60
Loeni Studer BETAfilam	9593	JE-H(S)H FE 180/E30 - E90	2	2	n x 2 x 0.8	X-EAS-FE 15-19 MX	30 cm	2	E30 - E90
Loeni Studer BETAfilam	9593	JE-H(S)H FE 180/E30 - E90	4	2	n x 2 x 0.8	X-EAS-FE 26-31 MX	30 cm	2	E30 - E90
Loeni Studer BETAfilam	9593	JE-H(S)H FE 180/E30 - E90	2	2	n x 2 x 0.8	X-EAS-FE 20-25 MX	30 cm	3	E30 - E90
Eupen EUCASAFE	6563	JE-H(ST)H...Bd FE 180 E90	2	2	n x 2 x 0.8	X-EAS-FE 20-25 MX	30 cm	2	E30 - E90
Eupen EUCASAFE	6563	JE-H(ST)H...Bd FE 180 E90	4	2	n x 2 x 0.8	X-EAS-FE 26-31 MX	30 cm	2	E30 - E90
Loeni Studer BETAfilam	8238	JE-H(S)HRH FE 180/E30 - E90	2	2	n x 2 x 0.8	X-EAS-FE 20-25 MX	30 cm	2	E30 - E90
Loeni Studer BETAfilam	8238	JE-H(S)HRH FE 180/E30 - E90	2	2	n x 2 x 0.8	X-EAS-FE 26-31 MX	30 cm	3	E30 - E90
Prysmien SIENOPYR-PLUS	7787	JE-H(ST)H Bd FE 180 E30	2	2	n x 2 x 0.8	X-EAS-FE 26-31 MX	30 cm	2	E30 - E60
Helukabel	8553	JE-H(S)H Bd FE 180/E30 - E90	4	2	n x 2 x 0.8	X-EAS-FE 6-10 MX	30 cm	1	E30 - E90
Sauter-Brandmelde-Systemkabel	8336	JE-H(S)H FE 180/E30	1	2	n x 2 x 1.5	X-EAS-FE 6-10 MX	30 cm	1	E30 - E60

• Number of cores n ≥ 2.

Cable specific constructions according to DIN 4102-12

Cable manufacturer	VDE Nr.	Cable type	Number of cores (n)	Cable dimension	Clip type	Spacing	Cable per clip	Classification
Dätwyler KERAM	7780	(N)HXH FE 180 E30 - E60	2	n x 1.5- n x 2.5	X-EAS-FE 11-14 MX	60 cm	1	E30 - E90
Dätwyler KERAM	7780	(N)HXH FE 180 E30 - E60	3	n x 1.5- n x 4	X-EAS-FE 11-14 MX	60 cm	1	E30 - E90
Dätwyler KERAM	7780	(N)HXH FE 180 E30 - E60	3	n x 6- n x 10	X-EAS-FE 15-19 MX	60 cm	1	E30 - E90
Dätwyler KERAM	7780	(N)HXH FE 180 E30 - E60	4	n x 1.5- n x 2.5	X-EAS-FE 11-14 MX	60 cm	1	E30 - E90
Dätwyler KERAM	7780	(N)HXH FE 180 E30 - E60	4	n x 6	X-EAS-FE 15-19 MX	60 cm	1	E30 - E90
Dätwyler KERAM	7780	(N)HXH FE 180 E30 - E60	5	n x 1.5	X-EAS-FE 11-14 MX	60 cm	1	E30 - E90
Dätwyler KERAM	7780	(N)HXH FE 180 E30 - E60	5	n x 2.5- n x 10	X-EAS-FE 15-19 MX	60 cm	1	E30 - E90
Dätwyler KERAM	7780	(N)HXH FE 180 E30 - E60	7	n x 1.5- n x 6	X-EAS-FE 15-19 MX	60 cm	1	E30 - E90
Dätwyler KERAM	7780	(N)HXH FE 180 E30 - E60	10	n x 2.5	X-EAS-FE 20-25 MX	60 cm	1	E30 - E90
Dätwyler KERAM	7780	(N)HXH FE 180 E30 - E60	12	n x 1.5	X-EAS-FE 15-19 MX	60 cm	1	E30 - E90
Dätwyler KERAM	7780	(N)HXH FE 180 E30 - E60	12	n x 2.5	X-EAS-FE 20-25 MX	60 cm	1	E30 - E90
Dätwyler KERAM	7780	(N)HXH FE 180 E30 - E60	24	n x 1.5	X-EAS-FE 20-25 MX	60 cm	1	E30 - E90
Dätwyler KERAM	7780	(N)HXCH FE 180 E30 - E60	3	n x 10/10	X-EAS-FE 15-19 MX	60 cm	1	E30 - E90
Dätwyler KERAM	7780	(N)HXCH FE 180 E30 - E60	3	n x 25/16- n x 35/16	X-EAS-FE 26-31 MX	60 cm	1	E30 - E90
Dätwyler KERAM	7780	(N)HXCH FE 180 E30 - E60	4	n x 10/10	X-EAS-FE 20-25 MX	60 cm	1	E30 - E90
Dätwyler KERAM	7780	(N)HXCH FE 180 E30 - E60	4	n x 16/16	X-EAS-FE 20-25 MX	60 cm	1	E30 - E90
Dätwyler KERAM	7780	(N)HXCH FE 180 E30 - E60	4	n x 25/16- n x 35/16	X-EAS-FE 26-31 MX	60 cm	1	E30 - E90

• Number of cores n ≥ 2.

Base material properties and fastener positioning in base material

Regulation	Fastener spacing
Norm-/standard construction	s = 300 mm
Cable specific construction	s ≥ 300 mm

- For more details in relation to base material properties, please refer to the chapter Fastener selection guide in the Direct fastening Technology Manual (DFTM).

Performance data
Recommended resistance under tension and shear load

Designation	Tension load	Shear load	Fire rating cable holder	Testing according to
	N _{rec}	V _{rec}		
X-EAS-FE MX (Type 1, 2)	0.02 kN	0.02 kN	90 min	EN 1363-1: 2020-05

- Redundancy of fastening points is required.

System recommendation
System recommendation for fastening collated nails with battery-actuated tool

Designation				Battery-actuated tool			Base material		
	X-P 17 B3 MX	X-P 20 B3 MX	X-P 24 B3 MX	BX 3 ME			Soft concrete	Standard concrete	Tough concrete
X-EAS-FE MX (Type 1/2)	■	■		■			■	■	■
			■	■			■		

■ = recommended

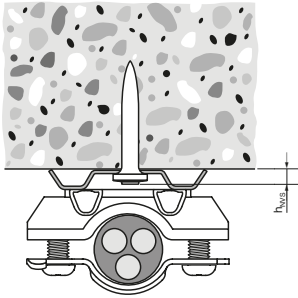
Quality assurance

$$h_{NVS, \min} = 3 \text{ mm}$$
$$h_{NVS, \max} = 6 \text{ mm}$$

Admissible fastener stand-off (Type 1)

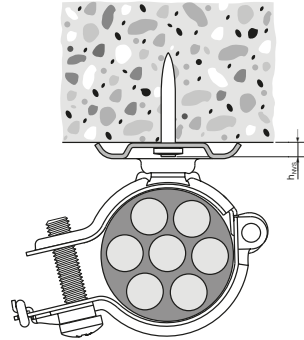

$$h_{NVS, \min} = 3 \text{ mm}$$
$$h_{NVS, \max} = 6 \text{ mm}$$

Admissible fastener stand-off (Type 2)

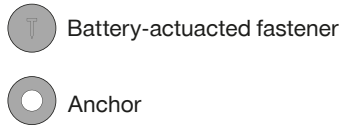
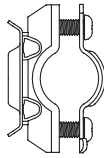
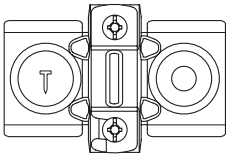
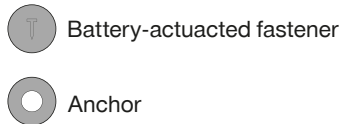
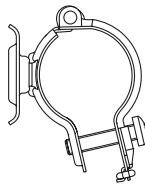
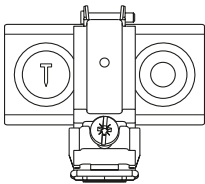
Fastening position (Type 1)

Fastening position (Type 2)

Fastener and anchor setting and installation information

- Fastener and anchor setting information (e.g. base material properties, fastened material properties and setting energy) and installation information (e.g. quality assurance) are part of the corresponding Product Data Sheet for fasteners and anchors.
- Fastener guide X-FG B3-ME recommended for fastener setting with battery-actuated tool. Holding the cable holder by hand no longer necessary.
- Visible setting failures must be replaced with a new fastener, not in the same hole.
- These are abbreviated instructions which may vary by application.
- Always review/follow the instructions accompanying the product.

X-FB Electrical conduit fastener

Product data

Product description

X-FB MX



- Quick, cost-efficient fastening of conduits and pipes
- Friction-fit in the nose of BX/GX/DX nailers for easy handling
- Bracing rib for high rigidity and a tight, secure hold on flexible conduits
- Engineered for high-quality, reliable fastening
- Virtually dust-free fastening

X-FB C-27



- Quick, cost-efficient fastening of conduits and pipes
- Integrated top hat for high-quality, more reliable fastenings
- High-grade, preassembled C27 nail for more secure fastenings on concrete
- Reinforcing rib to increase the conduit clip's rigidity

Dimensions for elements

Technical drawing	Designation	Diameter d	Length L	Width w	Height h
	X-FB 5 MX	5 mm	28.3 mm	17.5 mm	7 mm
	X-FB 6 MX	6 mm	29.4 mm	17.5 mm	8 mm
	X-FB 7 MX	7 mm	30.4 mm	17.5 mm	9 mm
	X-FB 8 MX	8 mm	31.3 mm	17.5 mm	10 mm
	X-FB 9 MX	9 mm	32.3 mm	17.5 mm	10 mm
	X-FB 10 MX	10 mm	33.3 mm	17.5 mm	11 mm
	X-FB 11 MX	11 mm	34.4 mm	17.5 mm	11.5 mm
	X-FB 13 MX	13 mm	36.5 mm	17.5 mm	15 mm
	X-FB 16 MX	16 mm	39.6 mm	17.5 mm	18 mm
	X-FB 20 MX	20 mm	43.8 mm	17.5 mm	22 mm
	X-FB 22 MX	22 mm	45.9 mm	17.5 mm	24 mm
	X-FB 25 MX	25 mm	49.0 mm	17.5 mm	27 mm
	X-FB 28 MX	28 mm	52.2 mm	17.5 mm	30 mm
	X-FB 32 MX	32 mm	56.3 mm	17.5 mm	34 mm
	X-FB 40 MX	40 mm	64.7 mm	17.5 mm	42 mm

Dimensions for elements with pre-mounted nails

Technical drawing	Designation	Diameter d	Length L	Width w	Height h
	X-FB 8 C27	8 mm	31.3 mm	17.7 mm	10 mm
	X-FB 11 C27	11 mm	34.4 mm	17.7 mm	13 mm
	X-FB 13 C27	13 mm	36.5 mm	17.7 mm	15 mm
	X-FB 16 C27	16 mm	39.6 mm	17.7 mm	18 mm
	X-FB 18 C27	18 mm	46.0 mm	17.7 mm	20 mm
	X-FB 20 C27	20 mm	43.8 mm	17.7 mm	22 mm
	X-FB 22 C27	22 mm	45.9 mm	17.7 mm	24 mm
	X-FB 24 C27	24 mm	52.0 mm	17.7 mm	26 mm
	X-FB 25 C27	25 mm	49.0 mm	17.7 mm	27 mm
	X-FB 28 C27	28 mm	52.2 mm	17.7 mm	30 mm
	X-FB 32 C27	32 mm	56.3 mm	17.7 mm	34 mm
	X-FB 35 C27	35 mm	64.0 mm	17.7 mm	37 mm
	X-FB 40 C27	40 mm	64.7 mm	17.7 mm	42 mm
	X-FB 50 C27	50 mm	77.0 mm	17.7 mm	52 mm

Dimensions for nails

Technical drawing	Designation	Shank length L_s	Head length L_h	Shank diameter d_s	Head diameter d_h
	X-C 27	27 mm	2 mm	3.5 mm	8 mm

Material specification and material properties for steel elements

Designation	Element	Material	Coating	Minimum coating thickness	Tensile strength f_u
X-FB MX	Element	Galvanized steel sheet	Zinc	10 μm	270–420 N/mm ²
X-FB-C27				5 μm	270–420 N/mm ²

Material specification and material properties for nails

Designation	Element	Material	Coating	Minimum coating thickness	Hardness
X-C 27	Nail	Carbon steel	Zinc	5 μm	56.5 HRC



• Info for single nails are part of the corresponding Product Data Sheets.

Approvals and certificates

Authority	Approval/ certificate no.	Date of issue	Country of issue
ITB	AT-15-7696/2016	12/2016	Poland
DIBt	ETA-16/0301	05/2019	Europe

Not all information presented in this product data sheet might be subject to approval / certificate content. Please refer to approval/certificate for further information.

Applications

Fastening conduits
to concrete

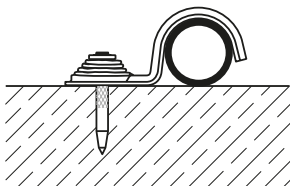

Fastening conduits
to steel

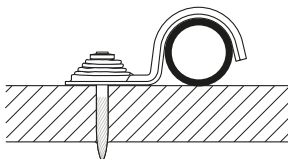

Base materials

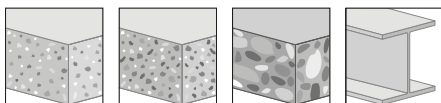

Soft concrete Medium concrete Tough concrete Steel

Load conditions



Static/
quasi static

Environmental conditions



Dry indoor

- The intended use comprises fastening in dry conditions or temporary outdoor conditions.
- For more details, please refer to following technical document: Hilti Corrosion Handbook.

Fastener program

Item no. and description

Designation	Item no.	Description
X-FB 5 MX	2074366	Element
X-FB 6 MX	2074367	
X-FB 7 MX	2074368	
X-FB 8 MX	286797	
X-FB 9 MX	2331461	
X-FB 10 MX	2331462	
X-FB 11 MX	286798	
X-FB 13 MX	2813209	
X-FB 16 MX	286799	
X-FB 20 MX	286800	
X-FB 22 MX	286801	
X-FB 25 MX	286802	
X-FB 28 MX	286803	
X-FB 32 MX	286804	
X-FB 40 MX	286805	Element with pre-mounted nail
X-FB 8 C27	401258	
X-FB 11 C27	401259	
X-FB 13 C27	401260	
X-FB 16 C27	401261	
X-FB 18 C27	401262	
X-FB 20 C27	401263	
X-FB 22 C27	401264	
X-FB 24 C27	401265	
X-FB 25 C27	401266	
X-FB 28 C27	401267	
X-FB 32 C27	401268	
X-FB 35 C27	401269	
X-FB 40 C27	401270	
X-FB 50 C27	401271	

X-FB Electrical conduit fastener – Fastening to concrete

Application recommendation

Fastened material properties

Fastening conduits and pipes with $5 \leq \varnothing \leq 50$ mm.

Base material properties and fastener positioning in base material

	Base material	Concrete
	Base material thickness h_{min}	80 mm (powder-actuated)
	Base material thickness h_{min}	60 mm (battery/gas-actuated)
	Edge distance $c_{1,min}$, $c_{2,min}$	70 mm
	Fastener spacing $s_{1,min}$, $s_{2,min}$	100 mm

Performance data

Recommended resistance under tension load

Designation	Nail length L_s	Tension load N_{rec}	
		Soft/medium concrete	Tough concrete
X-FB MX + X-X	22–27 mm	0.06 kN	0.06 kN
X-FB MX + X-P, X-U	22–27 mm	0.06 kN	0.06 kN
X-FB MX + X-C	22–27 mm	0.06 kN	0.06 kN
X-FB MX + X-P B3 MX	20–24 mm	0.02 kN	0.02 kN
X-FB MX + X-P G3 MX	20–24 mm	0.02 kN	0.02 kN
X-FB-C 27	27 mm	0.06 kN	0.06 kN

- Redundancy of fastening points is required.
- Minimum number of fastening points for safety relevant fastenings: ≥ 5 .
- For more details, please refer to the chapter **Fastener selection guide** in the Direct Fastening Technology Manual (DFTM).

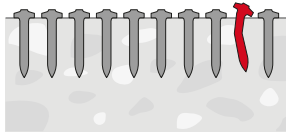
Stick rate estimation

Designation	Soft/medium concrete	Tough concrete
X-FB MX + X-X	90–99%	85–90%
X-FB MX + X-P, X-U, X-C	–	–
X-FB MX + X-P B3 MX	85–98%	70–85%
X-FB MX + X-P G3 MX	75–90%	55–70%
X-FB-C 27	–	–



- The stick rate indicates the percentage of nails that were driven correctly to carry a load.
- Stick rate can vary from the above values depending on job site conditions.

System recommendation

- For more details, please refer to the chapter **Accessories and consumables compatibility** in the Direct Fastening Technology Manual (DFTM).

System recommendation for fastening collated nails with powder-actuated tools

Designation	Powder-actuated tool			Base material		
	DX 6 MX	DX 5 MX	DX 460 MX	Soft concrete	Medium concrete	Tough concrete
X-FB MX + X-X MX	■	■	□	■	■	■
X-FB MX + X-P MX, X-U MX	■	■	□	■	■	■
X-FB MX + X-C MX	■	■	□	■	■	■

■ = recommended □ = feasible

System recommendation for fastening single nails with powder-actuated tool

Designation	Powder-actuated tool				Base material			
	DX 6 F8	DX 5 F8	DX 460 F8	DX 2	Soft concrete	Medium concrete		
X-FB-C 27	■	■	□		■	■		
X-FB-C 27				■	■	■		

■ = recommended □ = feasible

Cartridge recommendation

Base material	Cartridge color (tool power level)	
	Tool type: DX 6 MX DX 6 F8 Cartridge type: 6.8/11 M	Tool type: DX 5 MX, DX 460 MX DX 5 F8, DX 460 F8, DX 2 Cartridge type: 6.8/11 M
Soft/medium concrete	titanium ■ (2-5)	yellow ■, red ■
Tough concrete	titanium ■ (4-7)	yellow ■, red ■

- Tool power level adjustment by setting tests on site.
- Start tool energy selection with lowest recommended tool power level.
- Correct according requirement from chapter quality assurance.

System recommendation for fastening collated nails with battery-actuated tools

Designation	Battery-actuated tool				Base material		
	BX 3 ME				Soft concrete	Medium concrete	Tough concrete
X-FB MX + X-P B3 MX	■				■	■	□

■ = recommended □ = feasible

System recommendation for fastening collated nails with gas-actuated tools

Designation	Gas-actuated tool				Base material			
	GX 3-ME	GX 120-ME			Soft concrete	Medium concrete	Tough concrete	
X-FB MX + X-P G3 MX	■				■	■	□	
X-FB MX + X-GHP MX		■			■	■	□	

■ = recommended □ = feasible

Quality assurance
Setting depth control

	Fastener stand-off h_{NVS}	7–11 mm
--	------------------------------	---------

- Visible setting failures must be replaced with a new fastener, not in the same hole.
- These are abbreviated instructions which may vary by application.
- Always review/follow the instructions accompanying the product.

X-FB Electrical conduit fastener – Fastening to steel

Application recommendation

Fastened material properties

Fastening conduits and pipes with $5 \leq \varnothing \leq 50$ mm.

Base material properties and fastener positioning in base material

	Base material	Steel
	Base material thickness $t_{il, min}$	6 mm (powder-actuated)
	Base material thickness $t_{il, min}$	4 mm (battery/gas-actuated)
	Edge distance c_{min}	15 mm
	Fastener spacing s_{min}	20 mm

Performance data

Recommended resistance under tension load

Designation	Nail length L_s	Tension load
		N_{rec} Steel S235 to S355
X-FB MX + X-X 22 MX	22 mm	0.06 kN
X-FB MX + X-U 16 MX	16 mm	0.06 kN
X-FB MX + X-S 14 B3 MX	14 mm	0.06 kN
X-FB MX + X-S 14 G3 MX	14 mm	0.06 kN



- Redundancy of fastening points is required.
- Minimum number of fastening points for safety relevant fastenings: ≥ 5 .

System recommendation

- For more details, please refer to the chapter **Accessories and consumables compatibility** in the Direct Fastening Technology Manual (DFTM).

System recommendation for fastening collated nails with powder-actuated tools

Designation	Powder-actuated tool				Base material			
	DX 6 MX	DX 5 MX	DX 460 MX		Steel S235	Steel S275	Steel S335	
X-FB MX + X-X 22 MX	■	■	□		■	■	■	
X-FB MX + X-U 16 MX	■	■	□		■	■	■	

■ = recommended □ = feasible

Cartridge recommendation for X-FB MX + X-X 22 MX

Base material		Cartridge color (tool power level)	
		Tool type: DX 6 MX	Tool type: DX 5 MX, DX 460 MX
		Cartridge type: 6.8/11 M	Cartridge type: 6.8/11 M
S235	$6 \leq t_{II} \leq 12$ mm	titanium ■ (4-8)	yellow ■, red ■, black ■
S275	$6 \leq t_{II} \leq 10$ mm	titanium ■ (4-8), black ■ (7-8)	yellow ■, red ■, black ■
S355	$6 \leq t_{II} \leq 8$ mm	titanium ■ (6-8), black ■ (7-8)	red ■, black ■

Cartridge recommendation for X-FB MX + X-U 16 MX

Base material		Cartridge color (tool power level)	
		Tool type: DX 6 MX	Tool type: DX 5 MX, DX 460 MX
		Cartridge type: 6.8/11 M	Cartridge type: 6.8/11 M
S235	$6 \leq t_{II} \leq 10$ mm	titanium ■ (4-8)	red ■
	$10 \leq t_{II} \leq 20$ mm	titanium ■ (5-8), black ■ (7-8)	black ■
S275, S355	$6 \leq t_{II} \leq 8$ mm	titanium ■ (5-8), black ■ (7-8)	black ■

- Tool power level adjustment by setting tests on site.
- Start tool energy selection with lowest recommended tool power level.
- Correct according requirement from chapter quality assurance.

System recommendation for fastening collated nails with battery-actuated tool

Designation	Battery-actuated tool				Base material			
	BX 3-ME				Steel S235	Steel S275	Steel S335	
X-FB MX + X-S 14 B3 MX	■				■	■	■	

■ = recommended □ = feasible

System recommendation for fastening collated nails with gas-actuated tool

Designation	Gas-actuated tool				Base material			
	GX 3-ME				Steel S235	Steel S275	Steel S335	
X-FB MX + X-S 14 G3 MX	■				■	■	■	

■ = recommended □ = feasible

Quality assurance

Setting depth control

	Fastener stand-off h_{NVS}	7–9 mm
--	------------------------------	--------

- Visible setting failures must be replaced with a new fastener, not in the same hole.
- These are abbreviated instructions which may vary by application.
- Always review /follow the instructions accompanying the product.

X-DFB, X-EMTC Electrical conduit fastener

Product data

Dimensions

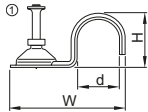
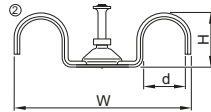
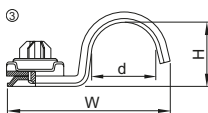
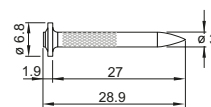
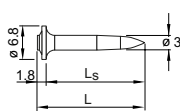
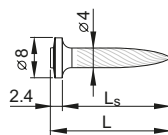
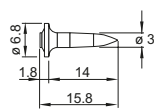
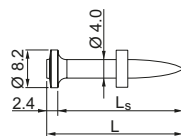
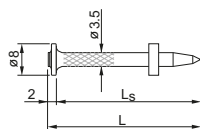
X-EMTC

X-DFB

X-BX/X-EMTC

X-GN 27

X-GHP 20/24

X-U 16/22/27

X-EGN 14

X-P 22/27

X-C 27

Material specifications



- See fastener program in the next pages.

Recommended fastening tools

DX 6 MX, DX 5 MX, DX 460 MX, DX 351 MX,
DX 6 F8, DX 5 F8, DX 460 F8, DX 351 F8,
BX 3 ME, GX 120 ME, GX 3 ME

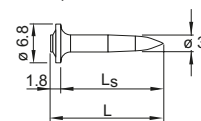
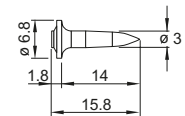
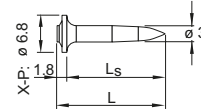
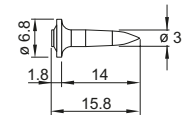
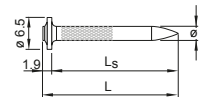
X-P 20/24 G3 MX

X-S 14 G3 MX

X-P 20/24 B3 MX

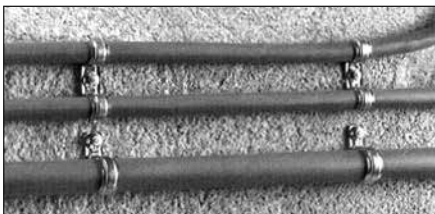
X-S 14 B3 MX

X-C 27 G3 MX

Applications

Example



Performance data

Recommended loads under shear and tension

Designation	Concrete	Sandlime stone	Steel
	N_{rec}	N_{rec}	N_{rec}
X-DFB (pre-mounted)	0.06 kN	0.06 kN	–
X-EMTC MX with X-U, X-P or X-C ($L_s = 22-27$ mm)	0.06 kN	0.06 kN	–
X-EMTC MX with X-U 16 MX	–	–	0.06 kN
X-EMTC MX with X-P B3 MX, X-P G3 MX or X-GHP ($L_s = 20-24$ mm)	0.02 kN	–	–
X-EMTC MX with X-C 27 G3 MX or X-GN 27 MX	–	0.06 kN	–
X-EMTC MX with X-S 14 B3 MX, X-S 14 G3 MX, X-EGN 14 MX or X-U 16 MX	–	–	0.06 kN

- For more details in relation to base material properties, please refer to the chapter **Fastener selection guide** in the Direct Fastening Manual (DFTM).

Application recommendation

Base material thickness

Concrete		Steel
X-U, X-P or X-C	$h_{min} = 80$ mm	$t_{II} \geq 4$ mm
X-P B3 MX, X-P G3 MX, X-GHP, X-C 27 G3 MX, X-GN 27 MX	$h_{min} = 60$ mm	

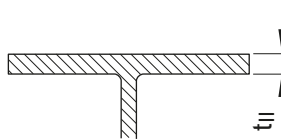

Fastened material thickness

X-BX, X-EMTC To fasten conduits, pipes and tubes of \varnothing 5 mm to 50 mm

Fastener positioning

Space fastenings as needed to control sag and maintain alignment.

Corrosion information

- These zinc-coated fasteners are not suitable for long-term service outdoors or in otherwise corrosive environments.
- For more details, please refer to following technical document: Hilti Corrosion Handbook.

System recommendation

- For more details, please refer to the chapter **Accessories and consumables compatibility** in the Direct Fastening Technology Manual (DFTM).

Cartridge recommendation for fastening to concrete

Base material	Cartridge color (tool power level)	
	Tool type: DX 6 MX DX 6 F8 Cartridge type: 6.8/11 M	Tool type: DX 5 MX, DX 460 MX, DX 351 MX DX 5 F8, DX 460 F8, DX 351 F8, DX 2 Cartridge type: 6.8/11 M
Soft/medium concrete	titanium ■ (2-5)	yellow ■, red ■
Tough concrete	titanium ■ (4-7)	yellow ■, red ■

Cartridge recommendation for fastening to steel

Base material	Cartridge color (tool power level)	
	Tool type: DX 6 MX DX 6 F8 Cartridge type: 6.8/11 M	Tool type: DX 5 MX, DX 460 MX, DX 351 MX DX 5 F8, DX 460 F8, DX 351 F8, DX 2 Cartridge type: 6.8/11 M
S235, S275, S355	$4 \leq t_{II} \leq 20 \text{ mm}$ titanium ■ (2-8)	yellow ■, red ■

- Tool power level adjustment by setting tests on site.
- Start tool energy selection with lowest recommended tool power level.
- Correct according requirement from chapter quality assurance.

Quality assurance

Nailhead not protruding

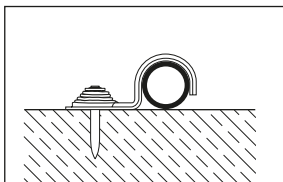

Fastener program

Technical information

With pre-mounted nail		Without pre-mounted nail		
Designation	Designation	d	W	H
① X-EMTC 3/8"-C27/-U22	③ X-EMTC 3/8" MX	10 mm (3/8")	33 mm	12 mm
① X-EMTC 3/8"-C27/-U22		13 mm (1/2")		
	③ X-EMTC 1/2" MX	13 mm (1/2")	42 mm	15 mm
① X-EMTC 3/4"-C27/-U22	③ X-EMTC 3/4" MX	19 mm (3/4")	47 mm	21 mm
	③ X-EMTC 1" MX	25 mm (1")	53 mm	27 mm
① X-EMTC 1"-C27/-U22		25 mm (1")		
	③ X-DFB 5 MX	5 mm	47 mm	7 mm
	③ X-DFB 6 MX	6 mm	50 mm	8 mm
	③ X-DFB 7 MX	7 mm	52 mm	9 mm
② X-DFB 8-C27	③ X-DFB 8 MX	8 mm		9.5 mm
	③ X-DFB 9 MX	9 mm	55.5 mm	11 mm
	③ X-DFB 10 MX	10 mm	57.5 mm	11.5 mm
② X-DFB 11-C27	③ X-DFB 11 MX	11 mm		12.5 mm
	③ X-DFB 13 MX	13 mm	64.2 mm	14.5 mm
② X-DFB 16-C27	③ X-DFB 16 MX	16 mm	66 mm	15 mm
② X-DFB 18-C27		18 mm	70 mm	18 mm
② X-DFB 20-C27	③ X-DFB 20 MX	20 mm	75 mm	20 mm
② X-DFB 22-C27	③ X-DFB 22 MX	22 mm	79 mm	22 mm
② X-DFB 24-C27	③ X-DFB 25 MX	24 mm	83 mm	24 mm
② X-DFB 25-C27		25 mm		
② X-DFB 28-C27	③ X-DFB 28 MX	28 mm	91 mm	28 mm
② X-DFB 35-C27		35 mm	106 mm	30 mm
② X-DFB 40-C27		40 mm	116 mm	37 mm

Material specification

- ① + ② Galvanized steel sheet, $f_u = 270-420 \text{ N/mm}^2$, 10-20 μm zinc coating
- ③ Galvanized steel sheet, $f_u = 270-420 \text{ N/mm}^2$, $\geq 5 \mu\text{m}$ zinc coating

Tools

DX 6 F8, DX 5 F8, DX 460 F8, DX 351 F8

for all X-DFB/EMTC with pre-mounted nails

and

DX 6 MX, DX 5 MX, DX 460 MX, DX 351 MX, GX 120 ME, GX 3 ME, BX 3 ME

for X-DFB/EMTC __MX

Item no. and description

Designation	Item no.	Description
X-EMTC 3/8"-C27/-U22		With pre-mounted nail
X-EMTC 3/8"-C27/-U22		
X-EMTC 3/4"-C27/-U22		
X-EMTC 1"-C27/-U22		
X-DFB 8-C27		
X-DFB 11-C27		
X-DFB 16-C27		
X-DFB 18-C27		
X-DFB 20-C27		
X-DFB 22-C27		
X-DFB 24-C27		
X-DFB 25-C27		
X-DFB 28-C27		
X-DFB 35-C27		
X-DFB 40-C27		Without pre-mounted nail
X-EMTC 3/8" MX		
X-EMTC 1/2" MX		
X-EMTC 3/4" MX		
X-EMTC 1" MX		
X-DFB 5 MX		
X-DFB 6 MX		
X-DFB 7 MX		
X-DFB 8 MX		
X-DFB 9 MX	2331463	
X-DFB 10 MX	2331464	
X-DFB 11 MX		
X-DFB 13 MX	2331465	
X-DFB 16 MX		
X-DFB 20 MX		
X-DFB 22 MX		
X-DFB 25 MX		
X-DFB 28 MX		

X-FB-E, X-DFB-E Electrical conduit fastener

Product data

Dimensions

X-FB-E

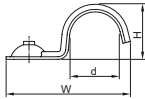

X-DFB-E

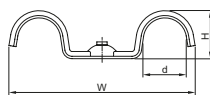

X-GN 20/27

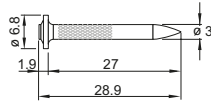

X-GHP 20

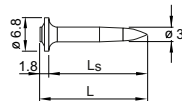

X-C 22/27

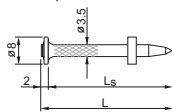

X-P 20 G3 MX

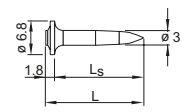

X-P 20 B3 MX

X-C 20 B3 MX

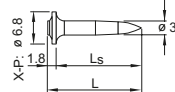

X-C 20/27 G3 MX

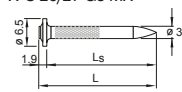

Material specifications

Galvanized steel sheet

$f_u = 270-420 \text{ N/mm}^2$

10-20 μm zinc coating

Recommended fastening tools

DX 6 MX, DX 5 MX, DX 460 MX, DX 351 MX,
DX 6 F8, DX 5 F8, DX 351 F8, DX 460 F8,
GX 120 ME, GX 3 ME, BX 3 ME



- See fastener program in the next pages.

Applications

Example



X-FB-E for rigid conduits



X-FB-E for flexible conduits

Performance data

Recommended resistance under tension load

Designation	Concrete N_{rec}	Sandlime stone N_{rec}
X-FB-E or X-DFB-E with X-GN 20, X-C 20 G3 MX or X-C 20 B3 MX	0.02 kN	0.02 kN
X-FB-E or X-DFB-E with X-GN 27 or X-C 27 G3 MX	0.06 kN	0.06 kN
X-FB-E or X-DFB-E with X-GHP 20, X-P 20 G3 MX or X-P 20 B3 MX	0.02 kN	–
X-FB-E or X-DFB-E with X-C 22/27	0.06 kN	0.06 kN

- For more details in relation to base material properties, please refer to the chapter **Fastener selection guide** in the Direct Fastening Manual (DFTM).

Application recommendation

Base material thickness

X-GN, X-GHP, X-C G3 MX, X-P G3 MX:	$h_{min} = 60 \text{ mm}$
X-C B3 MX, X-P B3 MX:	$h_{min} = 60 \text{ mm}$
X-C:	$h_{min} = 80 \text{ mm}$

Fastened material thickness

X-FB-E:	To fasten conduits, pipes and tubes of $\varnothing 16 \text{ mm}$ to 25 mm
X-DFB-E:	To fasten conduits, pipes and tubes of $\varnothing 20 \text{ mm}$ to 25 mm

Fastener positioning

Space fastenings as needed to control sag and maintain alignment.

Corrosion information

- These zinc-coated fasteners are not suitable for long-term service outdoors or in otherwise corrosive environments.
- For more details, please refer to following technical document: Hilti Corrosion Handbook.

System recommendation



- For more details, please refer to the chapter **Accessories and consumables compatibility** in the Direct Fastening Technology Manual (DFTM).

Cartridge recommendation for fastening to concrete and masonry

Base material	Cartridge color (tool power level)	
	Tool type: DX 6 MX	Tool type: DX 5 MX, DX 460 MX, DX 351 MX
	DX 6 F8	DX 5 F8, DX 460 F8, DX 351 F8, DX 2
	Cartridge type: 6.8/11 M	Cartridge type: 6.8/11 M
Sand lime masonry	titanium ■ (1-5)	green ■, yellow ■
Soft/medium concrete	titanium ■ (2-5)	yellow ■, red ■
Tough concrete	titanium ■ (4-7)	yellow ■, red ■



- Tool power level adjustment by setting tests on site.
- Start tool energy selection with lowest recommended tool power level.
- Correct according requirement from chapter quality assurance.

System recommendation for gas-actuated and battery-actuated tools

GX tools	GX 120-ME	Gas can GC 20, GC 21 and GC 22
	GX 3-ME	Gas can GC 40, GC 41 and GC 42
BX tools	BX 3-ME	No gas can required

Quality assurance

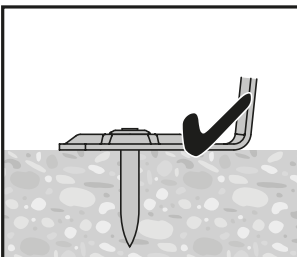

Nail head not protruding

Fastener program

Item no. and technical information

Designation	Item no.	d	W	H
X-FB-E 16 MX	2112585	16 mm	44 mm	17.5 mm
X-FB-E 20 MX	2112586	20 mm	48 mm	21.5 mm
X-FB-E 25 MX	2112587	25 mm	55 mm	26.5 mm
X-DFB-E 20 MX	2112588	20 mm	80 mm	20 mm
X-DFB-E 25 MX	2112589	25 mm	90 mm	25 mm

Tool selection

X-GN, X-GHP:	GX 120
X-C G3 MX, X-P G3 MX:	GX 3 ME
X-C B3 MX, X-C B3 MX	BX 3 ME
X-C_P8:	DX 6 F8, DX 5 F8, DX 460 F8, DX 351 F8
X-C_MX:	DX 6 MX, DX 5 MX, DX 460 MX, DX 351 MX

X-UCS MX Universal conduit saddle

Product data

Dimensions

X-UCS MX

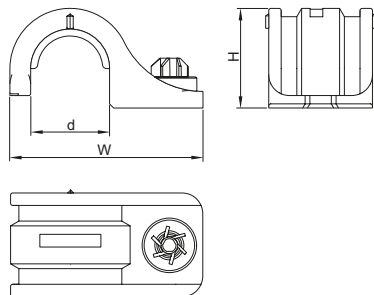

Features and benefits

- Easy and convenient installation to concrete (soft and tough) and sandlime stone base material
- Quick, cost-efficient fastening

General information

Material specification

X-UCS: PE (halogen and silicone free), light grey RAL 7035, free

Applications

Example



- Fastening flexible pipes and pipes with foam insulation for water and heating
- Fastening insulated injection hoses

The intended use only comprises fastenings which are not directly exposed to external weather conditions or moist atmospheres.

Load data

Recommended loads (Base material = concrete)

Fastener	Concrete / Sandlime stone N_{rec} [kN]
X-UCS MX	0.011

Design conditions:

- For pipes fastened with less than 5 fasteners and without any fixed end support, a test load has to be applied to each fastener, see Instruction For Use.
- All visible failures must be replaced.
- Predominantly static loading.
- Valid for soft and tough concrete with strength of $f_{c, \text{cube}} = 25\text{-}60 \text{ N/mm}^2$, that may contain medium sized aggregate e.g. limestone, pit gravel. please refer to **Concrete Fastener Selection** section in Hilti Direct Fastening Technology Manual (DFTM).
- Valid for sandlime stone.
- Observance of all application limitations and recommendations.
- Long-term behavior of X-UCS MX plastic material considered.

Fastener capacity

Fastening designation	Pipe diameter [mm]	Recommended fastener spacing on ceilings and walls [cm]
X-UCS 19 MX	19.0	80
X-UCS 23 MX	23.0	60
X-UCS 27.5 MX	27.5	40
X-UCS 30.5 MX	30.5	30

Comments:

- Recommended fastener spacing is based on recommended load and average weight of intended pipes during duty

Nail recommendations

For **concrete** base material

Fastening tool	Nail types	Length [mm]	Tip	Shank Ø [mm]	Material	Hardness [HRC]	Coating [µm]
BX 3 ME	X-P B3 MX	20 - 24	Ballistic	3.0	Carbon steel	57.5	Zinc, 2-13 µm
GX 3 ME	X-P G3 MX					57.5	Zinc, 2-13 µm
GX120	X-GHP MX					57.5	Zinc, 2-13 µm

- For the X-UCS MX element, only 20 mm and 24 mm pin lengths are recommended in order to ensure sufficient embedment depth.
- Premium nails (as listed above) are recommended for wall and ceiling application (soft and some tough concrete and sandlime stone, GX/BX tools). For more details regarding nail classification and concrete types, please refer to **Concrete Fastener Selection** section in Hilti Direct Fastening Technology Manual (DFTM).

For **concrete** base material

Fastening tool	Nail types	Length [mm]	Tip	Shank Ø [mm]	Material	Hardness [HRC]	Coating [µm]
BX 3 ME	X-C B3 MX	20 - 24	Cut	3.0	Carbon steel	56.5	Zinc, 2-13 µm
GX 3 ME	X-C G3 MX	20 - 27				56.5	Zinc, 2-13 µm
GX120	X-GN MX	20 - 27				53.5	Zinc, 2-13 µm

- For the X-UCS MX element, only 20 mm, 24 mm and 27 mm pin lengths are recommended in order to ensure sufficient embedment depth.
- Standard nails (as listed above) are recommended for floor application (soft concrete and sandlime stone, GX/BX tools). For more details regarding nail classification and concrete types, please refer to **Concrete Fastener Selection** section in Hilti Direct Fastening Technology Manual (DFTM).

Application requirements

Thickness of base material

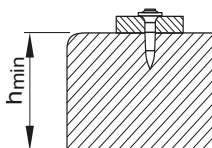

Concrete

**X-P B3 MX, X-P G3 MX,
X-GHP MX, X-C B3 MX,
X-C G3 MX, X-GN MX**

$h_{\min} = 60 \text{ mm}$

Edge distance

Min. edge distance = 70 mm

Corrosion information

Zinc-coated nails are not suitable for long-term service outdoors or in otherwise corrosive environments.

For further detailed information on corrosion see relevant chapter in **Direct Fastening Principles and Technique** section.

Fastener selection and system recommendation

Fastener program

Designation	Item no.	d [mm]	W [mm]	H [mm]
X-UCS 19 MX	2161565	19.0	46.5	24.0
X-UCS 23 MX	2161566	23.0	50.5	28.0
X-UCS 27.5 MX	2161567	27.5	55.0	32.5
X-UCS 30.5 MX	2161568	30.5	58.0	35.5

Tool selection

- X-P B3 MX, X-C B3 MX: BX 3-ME
- X-P G3 MX, X-C G3 MX: GX 3-ME
- X-GHP MX, X-GN MX: GX 120-ME

System recommendation

- GX 3-ME Gas can GC 40, GC 41 and GC 42
- GX 120-ME Gas can GC 20, GC 21 and GC 22
- BX 3-ME No gas can required

Fastening quality assurance

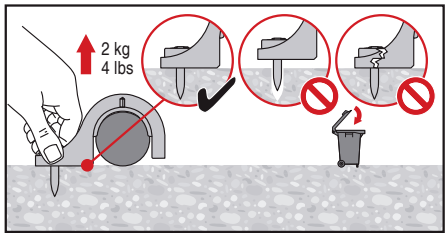
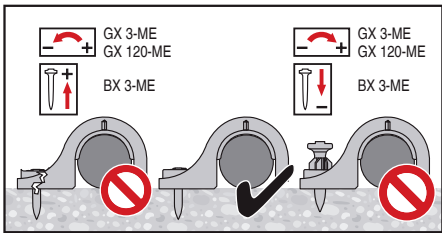

X-UCS-S MX Universal conduit saddle for rigid pipe

Product data

Dimensions

X-UCS-S MX

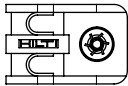
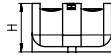
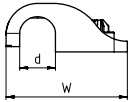

Features and benefits

The X-UCS-S MX enables easy and convenient installation to concrete floor (soft and some tough concrete).

General information

Material specification

X-UCS-S MX: HDPE (halogen and silicon free), light grey RAL 7035

Applications

Example



- Fastening rigid pipes and smooth surface pipes (without foam or grooved protection layer) for water and heating.

The intended use only comprises fastenings which are not directly exposed to external weather conditions or moist atmospheres.

Performance data

Fastener	Concrete / Sandlime stone V_{rec} [kN]
X-UCS-S MX	0.02

Design conditions:

- For pipes fastened with less than 5 fasteners and without any fixed end support, a test load has to be applied to each fastener, see Instruction For Use.
- All visible failures must be replaced.
- Predominantly static loading.
- Valid for soft and some tough concrete with strength of $f_{c,cube} = 25-60 \text{ N/mm}^2$, that may contain medium sized aggregate e.g. limestone, pit gravel. Please refer to **Concrete Fastener Selection** section in Hilti Direct Fastening Technology Manual (DFTM).
- Observance of all application limitations and recommendations.
- Long-term behavior of X-UCS-S MX plastic material considered.

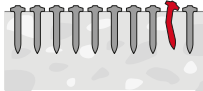

Stick rate estimation		
	Soft Concrete	Tough concrete
X-P B3	85% – 98%	70% – 85%
X-C B3	75% – 90%	55% – 70%

- The stick rate indicates the percentage of nails that were driven correctly to carry a load. Stick rate can vary from the above values depending on job site conditions.

Nail recommendations

For <u>concrete</u> base material							
Fastening tool	Nail types	Length [mm]	Tip	Shank Ø [mm]	Material	Hardness [HRC]	Coating [µm]
BX 3-ME (02)	X-P B3 MX	17 - 24	Long conical	3.0	Carbon steel	57.5	Zinc, 2-10
	X-C B3 MX	20 - 24	Cut			56.5	Zinc, 5-13

Design conditions:

- For more details regarding nail classification and concrete types, please refer to **Concrete Fastener Selection** section in Hilti Direct Fastening Technology Manual (DFTM).

Application requirements

Thickness of base material

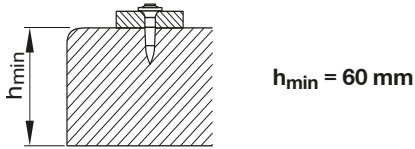

Edge distance

Min. edge distance = 70 mm

Spacing

- 50-100 cm along the pipe. Adjust spacing as needed to achieve stability of the pipe.
- At pipe turning 90 degree area, please refer to picture for distance between fasteners and orientation of fasteners.

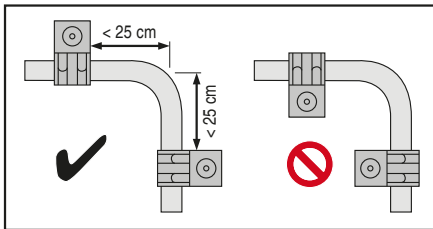

Corrosion information

Zinc-coated nails are not suitable for long-term service outdoors or in otherwise corrosive environments. For further detailed information on corrosion see relevant chapter in **Direct Fastening Principles and Technique** section.

Fastener selection and system recommendation
Fastener program

Designation	Item no.	Pipe Ø [mm]	d [mm]	W [mm]	H [mm]
X-UCS-S 13 MX	2212511	13.0	13.5	45.8	18.3
X-UCS-S 17 MX	2212512	17.0	17.4	49.4	22.2
X-UCS-S 21.5 MX	2212513	21.5	21.9	54.6	26.8
X-UCS-S 27 MX	2212429	27.0	27.4	59.6	32.3

Tool selection

X-P B3 MX, X-C B3 MX: BX 3-ME (02)

System recommendation

BX 3-ME (02): No gas can required

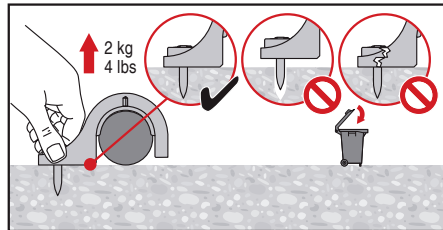
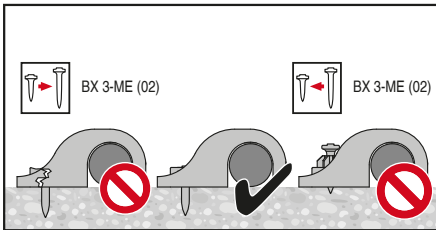
Fastening quality assurance

X-ECT MX, X-UCT MX, X-EKS MX Electrical cable tie and conduit clip fastener

Product data

Dimensions

X-ECT MX

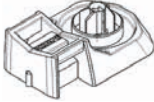

X-UCT MX



X-EKS MX

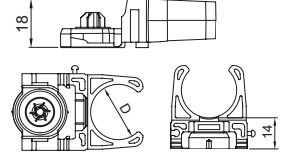

X-ECT 40 MX

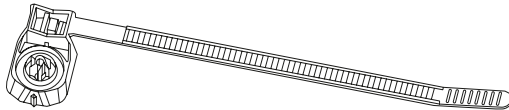

X-EKSC MX

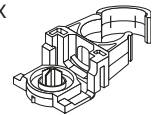

X-GHP 20/24

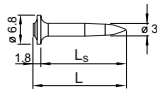

X-GN 27

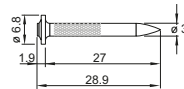

X-EGN 14

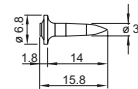

X-U 16/22/27

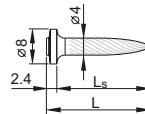

X-P 20/24 G3 MX

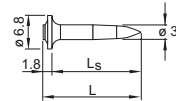

X-P 20/24 B3 MX

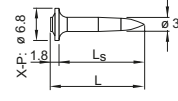

X-P 22/27

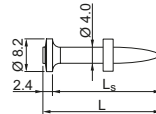

X-C 27 G3 MX

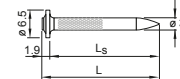

X-S 14 G3 MX

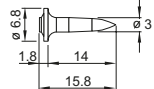

X-S 14 B3 MX

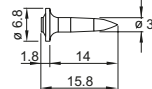

Material specifications and material properties

Material specification			Material properties			
Designation	Material	Colour	Silicone free	Halogen free	Flame retardant acc. to EN 60695-2-11, IEC 60695-2-11, VDE 0471 part 2-11 at 650°C at 960°C	
X-EKS 16 MX	PA	light grey (RAL 7035)	<input checked="" type="checkbox"/>	<input checked="" type="checkbox"/>	<input checked="" type="checkbox"/>	<input type="checkbox"/>
X-EKS 19 MX	PA	light grey (RAL 7035)	<input checked="" type="checkbox"/>	<input checked="" type="checkbox"/>	<input checked="" type="checkbox"/>	<input type="checkbox"/>
X-EKS 20 MX	PA	light grey (RAL 7035)	<input checked="" type="checkbox"/>	<input checked="" type="checkbox"/>	<input checked="" type="checkbox"/>	<input type="checkbox"/>
X-EKS 25 MX	PA	light grey (RAL 7035)	<input checked="" type="checkbox"/>	<input checked="" type="checkbox"/>	<input checked="" type="checkbox"/>	<input type="checkbox"/>
X-EKS 32 MX	PA	light grey (RAL 7035)	<input checked="" type="checkbox"/>	<input checked="" type="checkbox"/>	<input checked="" type="checkbox"/>	<input type="checkbox"/>
X-EKS 40 MX	PA	light grey (RAL 7035)	<input checked="" type="checkbox"/>	<input checked="" type="checkbox"/>	<input checked="" type="checkbox"/>	<input type="checkbox"/>
X-EKSC 16 MX	PA	light grey (RAL 7035)	<input checked="" type="checkbox"/>	<input checked="" type="checkbox"/>	<input checked="" type="checkbox"/>	<input type="checkbox"/>
X-EKSC 20 MX	PA	light grey (RAL 7035)	<input checked="" type="checkbox"/>	<input checked="" type="checkbox"/>	<input checked="" type="checkbox"/>	<input type="checkbox"/>
X-EKSC 25 MX	PA	light grey (RAL 7035)	<input checked="" type="checkbox"/>	<input checked="" type="checkbox"/>	<input checked="" type="checkbox"/>	<input type="checkbox"/>
X-EKSC 32 MX	PA	light grey (RAL 7035)	<input checked="" type="checkbox"/>	<input checked="" type="checkbox"/>	<input checked="" type="checkbox"/>	<input type="checkbox"/>
X-EKSC 40 MX	PA	light grey (RAL 7035)	<input checked="" type="checkbox"/>	<input checked="" type="checkbox"/>	<input checked="" type="checkbox"/>	<input type="checkbox"/>
X-ECT MX	PA	light grey (RAL 7035)	<input checked="" type="checkbox"/>	<input checked="" type="checkbox"/>	<input checked="" type="checkbox"/>	<input type="checkbox"/>
X-ECT UV MX	PA	black (RAL 9011)	<input checked="" type="checkbox"/>	<input checked="" type="checkbox"/>	<input checked="" type="checkbox"/>	<input type="checkbox"/>
X-ECT FR MX	PBT	stone grey (RAL 7030)	<input checked="" type="checkbox"/>	<input type="checkbox"/>	<input type="checkbox"/>	<input checked="" type="checkbox"/>
X-ECT 40 MX	PA	light grey (RAL 7035)	<input checked="" type="checkbox"/>	<input checked="" type="checkbox"/>	<input checked="" type="checkbox"/>	<input type="checkbox"/>
X-ECT U22	PA	black (RAL 9011)	<input checked="" type="checkbox"/>	<input checked="" type="checkbox"/>	<input checked="" type="checkbox"/>	<input type="checkbox"/>
X-ECT UV 22	PA	black (RAL 9011)	<input checked="" type="checkbox"/>	<input checked="" type="checkbox"/>	<input checked="" type="checkbox"/>	<input type="checkbox"/>
X-UCT MX	HDPE	light grey (RAL 7035)	<input checked="" type="checkbox"/>	<input checked="" type="checkbox"/>	<input type="checkbox"/>	<input type="checkbox"/>

- PA = Polyamide
- PBT = Polybutylenterephthalate
- HDPE = High-density polyethylene

Recommended fastening tools

DX 6 MX, DX 5 MX, DX 351 MX, DX 460 MX
 DX 6 F8, DX 5 F8, DX 460 F8, DX 351 F8, DX 2
 GX 120-ME, GX 3-ME, BX 3-ME

- See fastener program in the next pages.

Approvals and certificates

CSTB (France)	X-ECT MX, X-EKS MX, X-EKSC MX (all with X-U22 MX nail)
UL (USA)	X-ECT MX

i Not all information presented in this product data sheet might be subject to approval / certificate content. Please refer to approval/certificate for further information.

Applications

Examples



Flexible or rigid cable conduits with cable ties



Rigid conduits



Cable conduits or light duty pipes

Performance data

Recommended service load

Designation	Service load
X-ECT MX/X-ECT 40 MX, X-UCT MX	0.04 kN
X-EKS MX	0.011 kN

i • Recommended service load is determined by the serviceability of the plastic part.

Application recommendation

Base material thickness

Concrete

X-U, X-P:	$h_{\min} = 80 \text{ mm}$
X-P B3 MX:	$h_{\min} = 60 \text{ mm}$
X-P G3 MX, X-GHP:	$h_{\min} = 60 \text{ mm}$
X-C 27 G3 MX, X-GN 27 MX:	$h_{\min} = 60 \text{ mm}$

Steel

$t_{II} \geq 4 \text{ mm}$

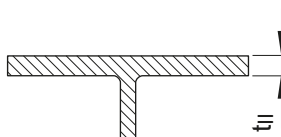

Spacing

50–100 cm along the cable tie. Adjust spacing as needed to achieve stability of cable tie

Corrosion information

- These zinc-coated fasteners are not suitable for long-term service outdoors or in otherwise corrosive environments.
- For more details, please refer to following technical document: Hilti Corrosion Handbook.

System recommendation

- For more details, please refer to the chapter **Accessories and consumables compatibility** in the Direct Fastening Technology Manual (DFTM).

Service installation information
Suitable cables with X-ECT MX, X-ECT 40 MX and X-UCT MX fastener

Cable type	Cable measure diameter	No. of cables
NYM 3x1.5	8 mm	14
NYM 5x1.5	10 mm	10

Suitable conduits with X-EKS/X-EKSC MX fastener

Conduit type	Conduit size	No. of conduits
Plastic conduit	16–40 mm	1

Power-actuated tool and fastener recommendation

Base material	Cable holder	Power-actuated tool	Fastener
Concrete or masonry	X-ECT MX X-EKS MX X-UCT MX	GX 3-ME	X-P 20/24 G3 MX X-C 27 G3 MX
		GX 120-ME	X-GHP 20/24 MX X-GN 27 MX
		BX 3-ME	X-P 20/24 B3 MX
	X-ECT MX X-EKS MX	DX 6 MX, DX 5 MX, DX 351 MX, DX 460 MX	X-U 22/27 MX X-P 22/27 MX
Steel	X-ECT MX X-EKS MX X-UCT MX	GX 3-ME	X-S 14 G3 MX
		GX 120-ME	X-EGN 14 MX
		BX 3-ME	X-S 14 B3 MX
	X-ECT MX X-EKS MX	DX 6 MX, DX 5 MX, DX 351 MX, DX 460 MX	X-U 16 MX

Cartridge recommendation for fastening to concrete and masonry

Base material	Cartridge color (tool power level)	
	Tool type: DX 6 MX	Tool type: DX 5 MX, DX 460 MX, DX 351 MX
	DX 6 F8	DX 5 F8, DX 460 F8, DX 351 F8, DX 2
	Cartridge type: 6.8/11 M	Cartridge type: 6.8/11 M
Sand lime masonry	titanium ■ (1-5)	green ■, yellow ■
Soft/medium concrete	titanium ■ (2-5)	yellow ■, red ■
Tough concrete	titanium ■ (4-7)	yellow ■, red ■



- Tool power level adjustment by setting tests on site.
- Start tool energy selection with lowest recommended tool power level.

System recommendation for gas-actuated tools

GX tools	GX 120-ME	Gas can GC 20, GC 21 and GC 22
	GX 3-ME	Gas can GC 40, GC 41 and GC 42

Fastener program
Item no. and description

Designation	Item no.	Description
X-EKS 16 MX	285719	X-EKS
X-EKS 19 MX	2105391	
X-EKS 20 MX	285720	
X-EKS 25 MX	285721	
X-EKS 32 MX	285722	
X-EKS 40 MX	285723	
X-EKSC 16 MX	274083	X-EKSC
X-EKSC 20 MX	274086	
X-EKSC 25 MX	274087	
X-EKSC 32 MX	386469	
X-EKSC 40 MX	386470	
X-ECT MX	285709	X-ECT
X-ECT UV MX	285710	
X-ECT FR MX	285711	
X-ECT 40 MX	432947	
X-ECT U22	288312	
X-ECT UV 22	288313	
X-UCT MX	2095183	X-UCT



X-UCT-E MX Universal cable tie holder

Product data

Dimensions

X-UCT-E MX

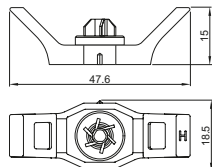

Fasteners for X-UCT-E MX
on **concrete** base material

X-U 22/27 MX

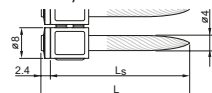

X-C 20/27 MX

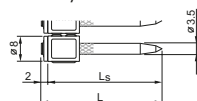

X-U 22/27 P8

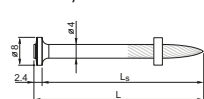

X-C 27 P8

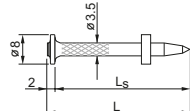

X-GHP 20/24 MX

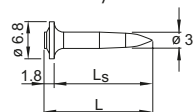

X-GN 20/27 MX

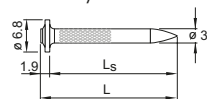

X-P 20/24 G3 MX

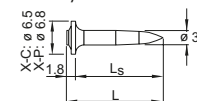

X-C 20/27 G3 MX

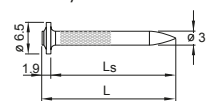

X-P 20/24 B3 MX

X-C 20/24 B3 MX

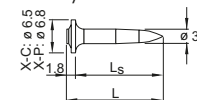

General information

Material specifications:

X-UCT-E MX	PE, light grey RAL 7035
X-U P8, X-U MX	Carbon steel, HRC 58.0, zinc coating 5-20 µm
X-C P8, X-C MX	Carbon steel, HRC 56.5, zinc coating 5-20 µm
X-GHP, X-EGN	Carbon steel, HRC 57.5, zinc coating 2-13 µm
X-GN	Carbon steel, HRC 53.5, zinc coating 2-13 µm
X-P G3 MX,	Carbon steel, HRC 57.5,
X-S G3 MX	zinc coating 2-13 µm
X-C G3 MX	Carbon steel, HRC 56.5,
	zinc coating 2-13 µm
X-P B3 MX,	Carbon steel, HRC 57.5,
X-S B3 MX	zinc coating 2-13 µm
X-C B3 MX	Carbon steel, HRC 56.5,
	zinc coating 2-13 µm

Recommended fastening tools

DX 351 MX, DX 351-F8, GX 120-ME, GX 3-ME, BX 3-ME

Fasteners for X-UCT-E MX on **steel** base material

X-U 16 MX

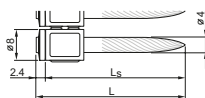

X-U 16 P8

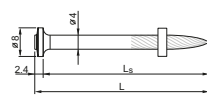

X-EGN 14 MX

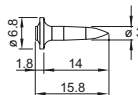

X-S 14 G3 MX / X-S 14 B3 MX

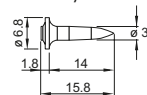

Applications

Examples



X-UCT-E MX with cable ties for two pipes



X-UCT-E MX with cable tie for single pipe

Load data

Recommended loads

Fastener	Service load ¹⁾ [kN]
X-UCT-E MX	0.04
X-UCT-E MX with 1 White cable tie	
X-UCT-E MX with 1 Blue <u>AND</u> 1 Red cable ties	
X-UCT-E MX with <u>EITHER</u> 1 Blue <u>OR</u> 1 Red cable tie	0.02

¹⁾ The recommended service load is determined by the serviceability of the plastic parts.

Application requirements

Thickness of base material

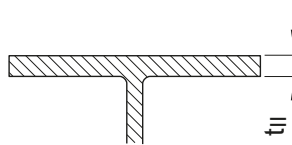
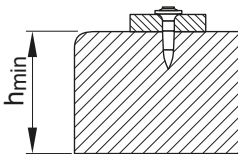

Concrete	
X-U MX, X-U P8, X-C MX, X-C P8	$h_{\min} = 80 \text{ mm}$
X-GHP MX, X-GN MX, X-P G3 MX, X-C G3 MX, X-P B3 MX, X-C B3 MX	$h_{\min} = 60 \text{ mm}$

Steel	
X-U 16 MX X-U 16 P8	$t_{II} \geq 6.0 \text{ mm}$
X-EGN 14 MX X-S 14 B3 MX	$t_{II} \geq 4.0 \text{ mm}$

Spacing and edge distances

Space fastenings (50 – 100 cm) as needed to control sag and maintain alignment of conduits.

Corrosion information

These zinc-coated fasteners are not suitable for long-term service outdoors or in otherwise corrosive environments.

For further detailed information on corrosion see relevant chapter in Direct Fastening Principles and Technique section.

Application limits

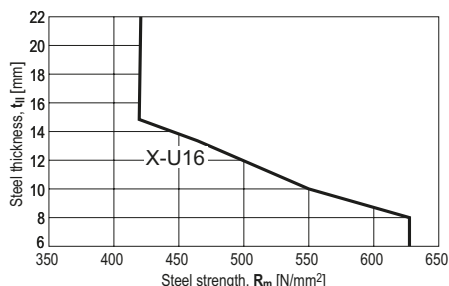
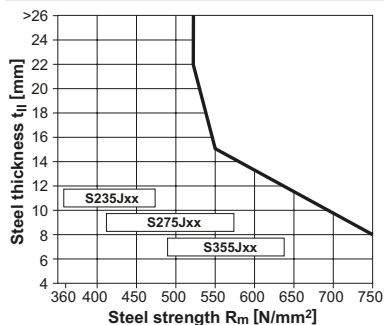

For fastening on steel base material

- X-EGN 14 MX
- X-S 14 B3 MX
- X-S 14 G3 MX

For fastening on steel base material

- X-U 16 MX

Fastener selection and system recommendation

Fastener program

Designation	Item no.	
X-UCT-E MX	2149226	X-UCT-E MX element

Tool selection

X-U MX, X-C MX:	DX 351 MX
X-U P8, X-C P8:	DX 351-F8
X-GHP MX, X-GN MX, X-EGN 14 MX :	GX 120-ME
X-P G3 MX, X-S G3 MX, X-C G3 MX:	GX 3-ME
X-P B3 MX, X-C B3 MX, X-S B3 MX:	BX 3-ME

System recommendation

DX 351 MX, DX 351-F8

Soft concrete: 6.8/11M green,

Tough concrete: 6.8/11M yellow, 6.8/11M red

GX 120-ME

Gas can GC 20, GC 21 and GC 22

GX 3-ME

Gas can GC 40, GC 41 and GC 42

BX 3-ME

No gas can required

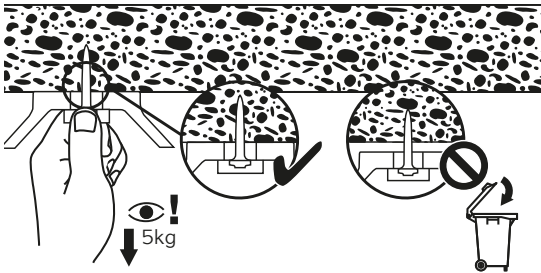
Fastening quality assurance

X-ET Nail for fastening plastic electrical cable tray and junction box

Product data

Dimensions

X-ET UK-H27

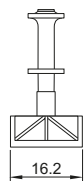
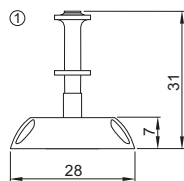

UK-H27

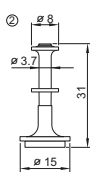

X-ET MX

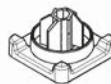

w x l x h = 16.5 x 16.5 x 12 mm

X-GHP 20/24

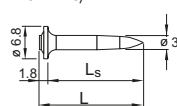

X-GN 27

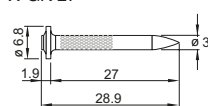

X-EGN 14

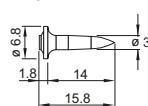

X-U 16/22/27

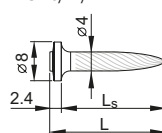

X-P 20/24 G3 MX

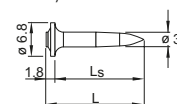

X-P 20/24 B3 MX

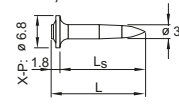

X-P 22/27

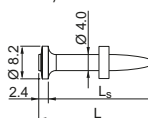

X-C 27 G3 MX

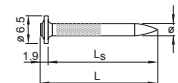

X-S 14 G3 MX

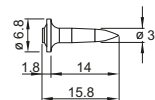

X-S 14 B3 MX

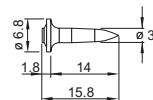

Material specifications

X-ET Polyethylene (PE)

X-ET MX Polyamide (PA), halogen and silicone free, light grey (RAL 7035) and Polybutylenterephthalate (PBT), silicone free, flame retardant, stone grey (RAL 7030)

Recommended fastening tools

DX 6 MX, DX 5 MX, DX 460 MX, DX 351 MX
 DX 6 F8, DX 5 F8, DX 460 F8, DX 351, DX 2
 GX 120-ME, GX 3-ME, BX 3-ME



• See fastener program in the next pages.

Applications

Examples



Cable trunking

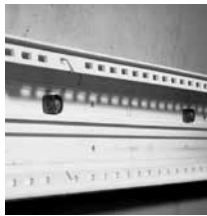

Cable trunking



Junction boxes



Conduits & pipes with metal or textile band

Performance data

Recommended service load

Designation	Service load
X-ET MX	0.1 kN

- Recommended service load is determined by the serviceability of the plastic part.

Application recommendation

Base material thickness

Concrete

X-U, X-P:	$h_{\min} = 80 \text{ mm}$
X-P B3 MX:	$h_{\min} = 60 \text{ mm}$
X-P G3 MX, X-GHP:	$h_{\min} = 60 \text{ mm}$
X-C 27 G3 MX, X-GN 27 MX:	$h_{\min} = 60 \text{ mm}$

Steel

$t_{II} \geq 4 \text{ mm}$

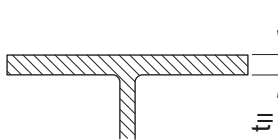

Corrosion information

- These zinc-coated fasteners are not suitable for long-term service outdoors or in otherwise corrosive environments.
- For more details, please refer to following technical document: Hilti Corrosion Handbook.

System recommendation



- For more details, please refer to the chapter **Accessories and consumables compatibility** in the Direct Fastening Technology Manual (DFTM).

Installation information

Conditions for use

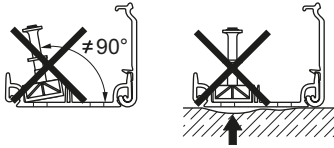

- No fastenings on ribs
- Underside of trunking must be smooth
- X-ET MX only in pre-drilled holes

Trunking dimensions and properties

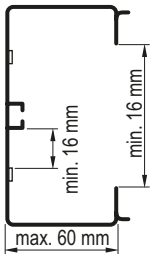

- Material thickness: $t_1 \leq 2 \text{ mm}$
- Material: PVC

Power-actuated tool and fastener recommendation

Base material	Cable holder	Power-actuated tool	Fastener
Concrete or masonry	X-ET MX	GX 3-ME	X-P 20/24 G3 MX
			X-C 27 G3 MX
		GX 120-ME	X-GHP 20/24 MX
			X-GN 27 MX
	X-ET UK-H27	DX 6 MX, DX 5 MX, DX 460 MX, DX 351 MX	X-U 22/27 MX
			X-P 22/27 MX
Steel	X-ET MX	GX 3-ME	X-S 14 G3 MX
			X-EGN 14 MX
		BX 3-ME	X-S 14 B3 MX
	X-ET UK-H27	DX 6 MX, DX 5 MX, DX 460 MX, DX 351 MX	X-U 16 MX

Cartridge recommendation for fastening to concrete and masonry

Base material	Cartridge color (tool power level)	
	Tool type: DX 6 MX	Tool type: DX 5 MX, DX 460 MX, DX 351 MX
	DX 6 F8	DX 5 F8, DX 460 F8, DX 351 F8, DX 2
	Cartridge type: 6.8/11 M	Cartridge type: 6.8/11 M
Sand lime masonry	titanium ■ (1-5)	green ■, yellow ■
Soft/medium concrete	titanium ■ (2-5)	yellow ■, red ■
Tough concrete	titanium ■ (4-8)	yellow ■, red ■



- Tool power level adjustment by setting tests on site.
- Start tool energy selection with lowest recommended tool power level.

Cartridge recommendation for fastening to steel

Base material	Cartridge color (tool power level)	
	Tool type: DX 6 MX	Tool type: DX 5 MX, DX 460 MX, DX 351 MX
	DX 6 F8	DX 5 F8, DX 460 F8, DX 351 F8, DX 2
	Cartridge type: 6.8/11 M	Cartridge type: 6.8/11 M
S235, S275, S355	$4 \leq t_{\parallel} \leq 14 \text{ mm}$	titanium ■ (2-8) yellow ■, red ■



- Tool power level adjustment by setting tests on site.
- Start tool energy selection with lowest recommended tool power level.

System recommendation for gas-actuated tools

GX tools	GX 120-ME	Gas can GC 20, GC 21 and GC 22
	GX 3-ME	Gas can GC 40, GC 41 and GC 42

Fastener program

Item no. and description

Designation	Item no.	Description
X-ET UK-H27	251705	X-ET
X-ET MX	285718	

X-TT Textile tape

Product data

X-TT



Features and benefits

- Quick and cost efficient fastening
- No finishing required
- Several pipes or conduits can be fastened to the floor in parallel
- X-ET fastener can be used for greater stability
- No sound transmission when used to fasten metal pipes

Environmental condition



Dry indoor
Floor application

Material specification and material properties

Designation	Item no.	Material	Material colour	Material width	Material thickness	Product ultimate tensile force	Temperature resistance	
							T _{min}	T _{max}
Textile tape	362096	PET	black	19.3 mm	1.2 mm	5000 N	-30° C	+80° C

Base material

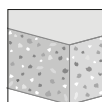

Soft concrete

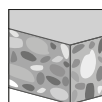

Tough concrete

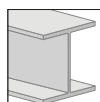

Steel

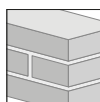

Masonry Solid brick

Application

Textile tape for cable and conduit fastening on floors.



Fastening quality assurance

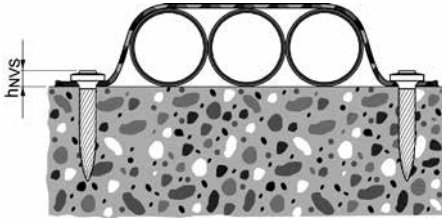

Admissible fastener stand-off

$$h_{NVS, \min} = 2.5 \text{ mm}$$

$$h_{NVS, \max} = 5.0 \text{ mm}$$

System recommendation

Product	Fastener						Battery-actuated tool	Base material			
	X-P 17 B3 MX	X-P 20 B3 MX	X-P 24 B3 MX	X-C 20 B3 MX	X-C 24 B3 MX	X-S 14 B3 MX		BX 3-ME	Soft concrete	Tough concrete	Steel
X-TT	■	■		■	■		■	■	■		■
			■	■	■	■	■			■	■

■ recommended



GX3-ME system recommendation in line with BX3-ME recommendation. GX 120-ME, GX3-ME, DX6 MX, DX5 MX, DX460 MX, DX351 MX system recommendation is part of the corresponding chapters within the Direct Fastening Technology Manual.

Setting information



Fastener setting information (e.g. base material properties and setting energy) is part of the corresponding Product Data Sheets for fasteners.

GX-WF Wood framing nail

Wood nail designation

GX	-	WF	[l_n] × [d_n]	(R)	(D)	34	(HDG)
Technology		Application	Dimension	Profile	Head Shape	Collation	Material

Technology:

GX | Gas driven

Application:

WF | Wood framing

Dimension:

[l_n] | Nail length [mm]
[d_n] | Nail diameter [mm]

Profile:

R | Profiled nail
() | Smooth nail

Head shape:

D | D-head
() | Round head



Collation:

34 | 34° Collation

Material:

() | Bright steel
galv | Galvanized steel
HDG | Hot dip galvanized steel
A2 | Stainless steel

Product data

GX-WF smooth nail  (example with D-head)	Product description <ul style="list-style-type: none"> • Round cross-sectional smooth nails with straight shank for use in load bearing timber structures • In accordance with EN 1995-1-1 smooth nails can be used for short to medium term withdrawal loads < 6 month or for shear loads only.
GX-WF profiled nail  (example with round head)	Product description <ul style="list-style-type: none"> • Round cross-sectional profiled nails with straight shank for use in load bearing timber structures • Collated nail for framing application • In accordance with EN 1995-1-1 profiled nails can be used for permanent or long-term withdrawal loads > 6 month and/or shear loads.

Recommended fastening tool

GX 90 WF

Material specification for GX-WF smooth nail

Designation	Available material/coating				Minimum tensile strength
	Bright steel	Galvanized steel	Hot-dip galvanized steel	Stainless steel	
GX-WF [l _n] × 2.8 D 34	●	●	●	N/A	f _u 600 N/mm ²
GX-WF [l _n] × 3.1 D 34	●	●	●	N/A	600 N/mm ²

Material specification for GX-WF profiled nail

Designation	Available material/coating				Minimum tensile strength
	Bright steel	Galvanized steel	Hot-dip galvanized steel	Stainless steel	
GX-WF [l _n] × 2.8 RD 34	●	●	●	●	600 N/mm ²
GX-WF [l _n] × 2.8 R 34	N/A	N/A	●	●	600 N/mm ²
GX-WF [l _n] × 3.1 RD 34	●	●	●	●	600 N/mm ²

Base material

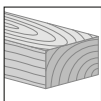

Wood

Load condition



Static/quasi static

Application

Examples

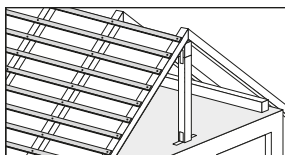

Battens

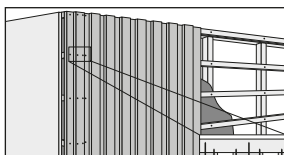

Cladding

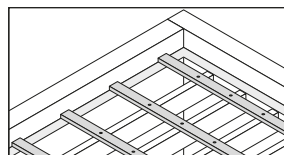

Flat roof

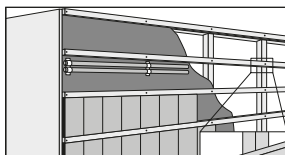

Sub-construction

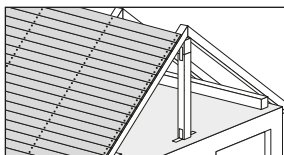

Roof paneling

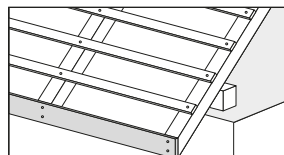

Roof trim

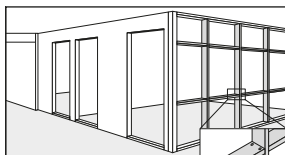

Wall framing

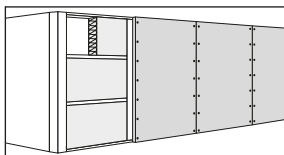

Wall sheeting

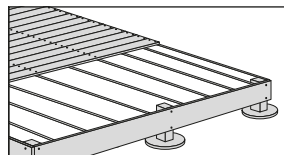

Wood decking

Corrosion information

Suitable GX-WF material related to service classes according to EN 1995-1-1

Service class	1	2	3
Average moisture content of the wood specimen	≤ 12%	≤ 20%	> 20%
Designation on package/label			
Requirements for nails with $d_n \leq 4 \text{ mm}$	No coating	Fe/Zn 12c	Fe/Zn 25c ¹⁾
Suitable GX-WF material	Bright steel Galvanized steel Hot-dip galvanized steel	Stainless steel Galvanized steel Hot-dip galvanized steel	Stainless steel Hot-dip galvanized steel Stainless steel

1) according to EN 10147, for hot-dip galvanized steel nails Fe/Zn 25 c is typically substituted by Z350.



Certain wood treatments and species, like Oak, Douglas-fir or similar, require stainless steel nails due to acidity of the wood. independent of the service class.

Mechanical strength and stiffness

Failures modes associated with design parameters, according to EN 1995-1-1



M_y Yield moment

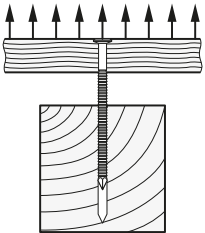

f_{ax} Withdrawal parameter

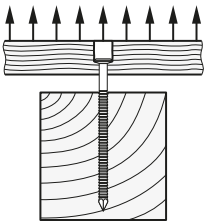

f_{head} Head pull-through parameter

Smooth nail

Designation	Available length	Tensile loading	Shear loading	Char. yield moment	Char. withdrawal parameter	Char. head pull-through parameter
	l_n /mm			$M_{y,k}$	$f_{ax,k}$	$f_{head,k}$
GX-WF [I _n] × 2.8 D 34	51, 63, 70, 75, 80	Medium term (< 6 months)	Permanent (> 10 years)	2617 Nmm	2.4 N/mm ²	8.5 N/mm ²
GX-WF [I _n] × 2.8 D 34 gal	51, 63, 70, 75, 80			2617 Nmm	2.4 N/mm ²	8.5 N/mm ²
GX-WF [I _n] × 2.8 D 34 HDG	51, 63, 75			2617 Nmm	2.4 N/mm ²	8.5 N/mm ²
GX-WF [I _n] × 3.1 D 34	80, 90			3410 Nmm	2.0 N/mm ²	8.5 N/mm ²
GX-WF [I _n] × 3.1 D 34 galv	75, 80, 90			3410 Nmm	2.0 N/mm ²	8.5 N/mm ²
GX-WF [I _n] × 3.1 D 34 HDG	75, 80, 90			3410 Nmm	2.0 N/mm ²	8.5 N/mm ²

Profiled nail

Designation	Available length	Tensile loading	Shear loading	Char. yield moment	Char. withdrawal parameter	Char. head pull-through parameter
	l_n /mm			$M_{y,k}$	$f_{ax,k}$	$f_{head,k}$
GX-WF [l_n] × 2.8 RD 34	51, 63, 70, 75, 80	Permanent (> 10 years)	Permanent (> 10 years)	2320 Nmm	6.9 N/mm ²	12.5 N/mm ²
GX-WF [l_n] × 2.8 RD 34 galv	51, 63, 70, 75, 80			2320 Nmm	6.9 N/mm ²	12.5 N/mm ²
GX-WF [l_n] × 2.8 RD 34 HDG	51, 63, 75, 80			2130 Nmm	6.9 N/mm ²	12.5 N/mm ²
GX-WF [l_n] × 2.8 RD 34 A2	51, 63			1960 Nmm	6.8 N/mm ²	12.5 N/mm ²
GX-WF [l_n] × 2.8 R 34 A2	55, 65, 80			1960 Nmm	6.8 N/mm ²	15.7 N/mm ²
GX-WF [l_n] × 2.8 R 34 HDG	50, 65, 75			2130 Nmm	6.9 N/mm ²	13.9 N/mm ²
GX-WF [l_n] × 3.1 RD 34 A2	80			2830 Nmm	6.2 N/mm ²	13.9 N/mm ²
GX-WF [l_n] × 3.1 RD 34	70, 75, 80, 90			2772 Nmm	6.7 N/mm ²	13.9 N/mm ²
GX-WF [l_n] × 3.1 RD 34 galv	70, 75, 80, 90			2772 Nmm	6.3 N/mm ²	13.9 N/mm ²
GX-WF [l_n] × 3.1 RD 34 HDG	63, 75, 80, 90					2772 Nmm

Dimension

Nail definition

Head shape

D-head

Round head



A_h Head cross-sectional area
 d_h Head diameter

Profiled nail

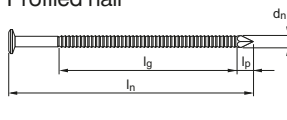

l_n Nominal nail length
 d_n Nominal nail diameter
 l_g Length of profiling
 l_p Point length

Fastening definition

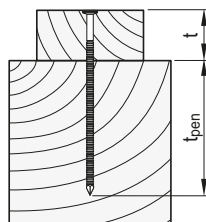

t Fastening height
 t_{pen} Pointside penetration depth

Bright steel nail, service class 1

Designation	Nominal nail length	Nominal nail diameter	Minimum head diameter	Minimum head cross-sectional area	Maximum fastening height	Length of profiling	Maximum point length
	l_n	d_n	d_h	$A_{h,min}$	t	l_g	l_p
GX-WF 51 × 2.8 D 34	51 mm	2.8 mm	7 mm	29.40 mm ²	28 mm	N/A	4.6 mm
GX-WF 63 × 2.8 D 34	63 mm	2.8 mm	7 mm	29.40 mm ²	40 mm	N/A	4.6 mm
GX-WF 70 × 2.8 D 34	70 mm	2.8 mm	7 mm	29.40 mm ²	47 mm	N/A	4.6 mm
GX-WF 75 × 2.8 D 34	75 mm	2.8 mm	7 mm	29.40 mm ²	52 mm	N/A	4.6 mm
GX-WF 80 × 2.8 D 34	80 mm	2.8 mm	7 mm	29.40 mm ²	57 mm	N/A	4.6 mm
GX-WF 80 × 3.1 D 34	80 mm	3.1 mm	7.2 mm	29.40 mm ²	55 mm	N/A	4.9 mm
GX-WF 90 × 3.1 D 34	90 mm	3.1 mm	7.2 mm	29.40 mm ²	65 mm	N/A	4.9 mm
GX-WF 51 × 2.8 RD 34	51 mm	2.8 mm	7 mm	29.40 mm ²	34 mm	34 mm	4.6 mm
GX-WF 63 × 2.8 RD 34	63 mm	2.8 mm	7 mm	29.40 mm ²	46 mm	46 mm	4.6 mm
GX-WF 70 × 2.8 RD 34	70 mm	2.8 mm	7 mm	29.40 mm ²	53 mm	53 mm	4.6 mm
GX-WF 75 × 2.8 RD 34	75 mm	2.8 mm	7 mm	29.40 mm ²	58 mm	58 mm	4.6 mm
GX-WF 80 × 2.8 RD 34	80 mm	2.8 mm	7 mm	29.40 mm ²	63 mm	63 mm	4.6 mm
GX-WF 70 × 3.1 RD 34	70 mm	3.1 mm	7.2 mm	29.40 mm ²	51 mm	53 mm	4.9 mm
GX-WF 75 × 3.1 RD 34	75 mm	3.1 mm	7.2 mm	29.40 mm ²	56 mm	58 mm	4.9 mm
GX-WF 80 × 3.1 RD 34	80 mm	3.1 mm	7.2 mm	29.40 mm ²	61 mm	63 mm	4.9 mm
GX-WF 90 × 3.1 RD 34	90 mm	3.1 mm	7.2 mm	29.40 mm ²	71 mm	73 mm	4.9 mm

Galvanized steel nail, service class 2

Designation	Nominal nail length	Nominal nail diameter	Minimum head diameter	Minimum head cross-sectional area	Maximum fastening height	Length of profiling	Maximum point length
	l_n	d_n	d_h	$A_{h,min}$	t	l_g	l_p
GX-WF 51 × 2.8 D 34 galv	51 mm	2.8 mm	7 mm	29.40 mm ²	28 mm	N/A	4.6 mm
GX-WF 63 × 2.8 D 34 galv	63 mm	2.8 mm	7 mm	29.40 mm ²	40 mm	N/A	4.3 mm
GX-WF 70 × 2.8 D 34 galv	70 mm	2.8 mm	7 mm	29.40 mm ²	47 mm	N/A	4.3 mm
GX-WF 75 × 2.8 D 34 galv	75 mm	2.8 mm	7 mm	29.40 mm ²	52 mm	N/A	4.3 mm
GX-WF 80 × 2.8 D 34 galv	80 mm	2.8 mm	7 mm	29.40 mm ²	57 mm	N/A	4.3 mm
GX-WF 75 × 3.1 D 34 galv	75 mm	3.1 mm	7.2 mm	29.40 mm ²	50 mm	N/A	4.8 mm
GX-WF 80 × 3.1 D 34 galv	80 mm	3.1 mm	7.2 mm	29.40 mm ²	55 mm	N/A	4.8 mm
GX-WF 90 × 3.1 D 34 galv	90 mm	3.1 mm	7.2 mm	29.40 mm ²	65 mm	N/A	4.8 mm
GX-WF 51 × 2.8 RD 34 galv	51 mm	2.8 mm	7 mm	29.40 mm ²	34 mm	34 mm	4.3 mm
GX-WF 63 × 2.8 RD 34 galv	63 mm	2.8 mm	7 mm	29.40 mm ²	46 mm	46 mm	4.3 mm
GX-WF 70 × 2.8 RD 34 galv	70 mm	2.8 mm	7 mm	29.40 mm ²	53 mm	53 mm	4.3 mm
GX-WF 75 × 2.8 RD 34 galv	75 mm	2.8 mm	7 mm	29.40 mm ²	58 mm	58 mm	4.3 mm
GX-WF 80 × 2.8 RD 34 galv	80 mm	2.8 mm	7 mm	29.40 mm ²	63 mm	63 mm	4.3 mm
GX-WF 70 × 3.1 RD 34 galv	70 mm	3.1 mm	7.2 mm	29.40 mm ²	51 mm	53 mm	4.8 mm
GX-WF 75 × 3.1 RD 34 galv	75 mm	3.1 mm	7.2 mm	29.40 mm ²	56 mm	58 mm	4.8 mm
GX-WF 80 × 3.1 RD 34 galv	80 mm	3.1 mm	7.2 mm	29.40 mm ²	61 mm	63 mm	4.8 mm
GX-WF 90 × 3.1 RD 34 galv	90 mm	3.1 mm	7.2 mm	29.40 mm ²	71 mm	73 mm	4.8 mm

Hot-dip galvanized steel nail, service class 3

Designation	Nominal nail length	Nominal nail diameter	Minimum head diameter	Minimum head cross-sectional area	Maximum fastening height	Length of profiling	Maximum point length
	l_n	d_n	d_h	$A_{h,min}$	t	l_g	l_p
GX-WF 51 × 2.8 D 34 HDG	51 mm	2.8 mm	7 mm	29.40 mm ²	28 mm	N/A	4.6 mm
GX-WF 63 × 2.8 D 34 HDG	63 mm	2.8 mm	7 mm	29.40 mm ²	40 mm	N/A	4.6 mm
GX-WF 75 × 2.8 D 34 HDG	75 mm	2.8 mm	7 mm	29.40 mm ²	52 mm	N/A	4.6 mm
GX-WF 75 × 3.1 D 34 HDG	75 mm	3.1 mm	7.2 mm	29.40 mm ²	50 mm	N/A	4.9 mm
GX-WF 80 × 3.1 D 34 HDG	80 mm	3.1 mm	7.2 mm	29.40 mm ²	55 mm	N/A	4.9 mm
GX-WF 90 × 3.1 D 34 HDG	90 mm	3.1 mm	7.2 mm	29.40 mm ²	65 mm	N/A	4.9 mm
GX-WF 51 × 2.8 RD 34 HDG	51 mm	2.8 mm	7 mm	29.40 mm ²	34 mm	34 mm	4.6 mm
GX-WF 63 × 2.8 RD 34 HDG	63 mm	2.8 mm	7 mm	29.40 mm ²	46 mm	46 mm	4.6 mm
GX-WF 75 × 2.8 RD 34 HDG	75 mm	2.8 mm	7 mm	29.40 mm ²	58 mm	58 mm	4.6 mm
GX-WF 80 × 2.8 RD 34 HDG	80 mm	2.8 mm	7 mm	29.40 mm ²	63 mm	63 mm	4.6 mm
GX-WF 63 × 3.1 RD 34 HDG	63 mm	3.1 mm	7.2 mm	29.40 mm ²	44 mm	46 mm	4.9 mm
GX-WF 75 × 3.1 RD 34 HDG	75 mm	3.1 mm	7.2 mm	29.40 mm ²	56 mm	58 mm	4.9 mm
GX-WF 80 × 3.1 RD 34 HDG	80 mm	3.1 mm	7.2 mm	29.40 mm ²	61 mm	63 mm	4.9 mm
GX-WF 90 × 3.1 RD 34 HDG	90 mm	3.1 mm	7.2 mm	29.40 mm ²	71 mm	73 mm	4.9 mm
GX-WF 50 × 2.8 R 34 HDG	50 mm	2.8 mm	6.4 mm	32.20 mm ²	33 mm	34 mm	4.6 mm
GX-WF 65 × 2.8 R 34 HDG	65 mm	2.8 mm	6.4 mm	32.20 mm ²	48 mm	49 mm	4.6 mm
GX-WF 75 × 2.8 R 34 HDG	75 mm	2.8 mm	6.4 mm	32.20 mm ²	59 mm	58 mm	4.6 mm

Stainless steel nail, service class 3

Designation	Nominal nail length	Nominal nail diameter	Minimum head diameter	Minimum head cross-sectional area	Maximum fastening height	Length of profiling	Maximum point length
	l_n	d_n	d_h	$A_{h,min}$	t	l_g	l_p
GX-WF 51 × 2.8 RD 34 A2	51 mm	2.8 mm	7.0 mm	29.40 mm ²	34 mm	34 mm	4.6 mm
GX-WF 63 × 2.8 RD 34 A2	63 mm	2.8 mm	7.0 mm	29.40 mm ²	46 mm	46 mm	4.6 mm
GX-WF 80 × 3.1 RD 34 A2	80 mm	3.1 mm	7.2 mm	29.40 mm ²	61 mm	63 mm	4.9 mm
GX-WF 55 × 2.8 R 34 A2	55 mm	2.8 mm	6.4 mm	32.20 mm ²	38 mm	38 mm	4.6 mm
GX-WF 65 × 2.8 R 34 A2	65 mm	2.8 mm	6.4 mm	32.20 mm ²	48 mm	48 mm	4.6 mm
GX-WF 80 × 2.8 R 34 A2	80 mm	2.8 mm	6.4 mm	32.20 mm ²	63 mm	63 mm	4.6 mm

Application requirement

Minimum pointside penetration depth, under tension load

For smooth nail: $t_{pen} = 8 \times d_n$

For profiled nail: $t_{pen} = 6 \times d_n$

Spacing and edge distance

Geometrical limitations, like spacing and edge distance, shall be in compliance with EN 1995-1-1 or other applicable regulations.

Fastening quality assurance

Fastening inspection for wood to wood connection

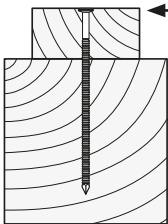

- 1 Nail head shall be flush with the wood surface
- 2 Fastened wood member should be fully in contact with the supporting wood member, if not differently required by the specific design of the connection.

Installation information

Pre-drilling

Pre-drilling requirements are described in EN 1995-1-1, section 8.3.1.2.

Item no.
Bright steel nail, service class 1

Designation	Item no.
GX-WF 51 × 2.8 D 34	2281814, 2083658
GX-WF 63 × 2.8 D 34	2281815, 2083659
GX-WF 70 × 2.8 D 34	2281816, 2083750
GX-WF 75 × 2.8 D 34	2281817, 2083751
GX-WF 80 × 2.8 D 34	2281818, 2083752
GX-WF 80 × 3.1 D 34	2281819, 2083753
GX-WF 90 × 3.1 D 34	2281820, 2083754
GX-WF 51 × 2.8 RD 34	2281821, 2083755
GX-WF 63 × 2.8 RD 34	2281822, 2083756
GX-WF 70 × 2.8 RD 34	2281823, 2083757
GX-WF 75 × 2.8 RD 34	2281824, 2083758
GX-WF 80 × 2.8 RD 34	2281833, 2083759
GX-WF 70 × 3.1 RD 34	2281825, 2083760
GX-WF 75 × 3.1 RD 34	2083761
GX-WF 80 × 3.1 RD 34	2281826, 2083762
GX-WF 90 × 3.1 RD 34	2281827, 2083763

Galvanized steel nail, service class 2

Designation	Item no.
GX-WF 51 × 2.8 D 34 galv	2281835, 2083764
GX-WF 63 × 2.8 D 34 galv	2281836, 2083765
GX-WF 70 × 2.8 D 34 galv	2281837, 2083766
GX-WF 75 × 2.8 D 34 galv	2281838, 2083767
GX-WF 80 × 2.8 D 34 galv	2281839, 2083768
GX-WF 75 × 3.1 D 34 galv	2281840, 2083769
GX-WF 80 × 3.1 D 34 galv	2281841, 2083770
GX-WF 90 × 3.1 D 34 galv	2281842, 2083771
GX-WF 51 × 2.8 RD 34 galv	2281843, 2083772
GX-WF 63 × 2.8 RD 34 galv	2281844, 2083773
GX-WF 70 × 2.8 RD 34 galv	2281845, 2083774
GX-WF 75 × 2.8 RD 34 galv	2281846, 2083775
GX-WF 80 × 2.8 RD 34 galv	2281847, 2083776
GX-WF 70 × 3.1 RD 34 galv	2281848, 2083777
GX-WF 75 × 3.1 RD 34 galv	2281849, 2083778
GX-WF 80 × 3.1 RD 34 galv	2281615, 2083779
GX-WF 90 × 3.1 RD 34 galv	2281834, 2083780

Hot-dip galvanized steel nail, service class 3

Designation	Item no.
GX-WF 51 × 2.8 D 34 HDG	2281616, 2083781
GX-WF 63 × 2.8 D 34 HDG	2281617, 2083782
GX-WF 75 × 2.8 D 34 HDG	2281618, 2083783
GX-WF 75 × 3.1 D 34 HDG	2281619, 2083784
GX-WF 80 × 3.1 D 34 HDG	2281800, 2083785
GX-WF 90 × 3.1 D 34 HDG	2281801, 2083786
GX-WF 51 × 2.8 RD 34 HDG	2281802, 2083787
GX-WF 63 × 2.8 RD 34 HDG	2281803, 2083788
GX-WF 75 × 2.8 RD 34 HDG	2281804, 2083789
GX-WF 80 × 2.8 RD 34 HDG	2281805, 2083790
GX-WF 63 × 3.1 RD 34 HDG	2281806, 2083791
GX-WF 75 × 3.1 RD 34 HDG	2281807, 2083792
GX-WF 80 × 3.1 RD 34 HDG	2281808, 2083793
GX-WF 90 × 3.1 RD 34 HDG	2281809, 2083794
GX-WF 50 × 2.8 R 34 HDG	2281810
GX-WF 65 × 2.8 R 34 HDG	2281811
GX-WF 51 × 2.8 R 34 HDG	2281812

Stainless steel nail, service class 3

Designation	Item no.
GX-WF 51 × 2.8 RD 34 A2	2281828, 2006654
GX-WF 63 × 2.8 RD 34 A2	2281829, 2006655
GX-WF 80 × 3.1 RD 34 A2	2281830, 2006656
GX-WF 55 × 2.8 R 34 A2	2281831, 2006657
GX-WF 65 × 2.8 R 34 A2	2281832, 2006658
GX-WF 80 × 2.8 R 34 A2	2281813, 2006659

Part 5:

Approvals

Nails → Approvals

Product	Approval	Country	Application
DNH	ITB AT-15-7696/2016	Poland	Fastening to steel and concrete
DS	ICC-ES ESR-1663	USA	Fastening to steel and concrete
	LR 97/00077(E4)	Global	Fastening to steel
	ITB AT-15-7235/2015	Poland	Fastening to steel and concrete
DX-Kwik	DIBt Z-21.7-670	Germany	Suspended ceiling fastening
	ETA-14/0426	Europe	Fastening to concrete
	IBMB 3041/8171	Germany	Fastening drywall track
	IBMB Gutachten 1498/166/13	Germany	Ceiling hanger fastening
	Rom. Ministry, ICECON: AT 016-01_389-2018	Romania	Fastening to concrete
EDS	DNV-GL TAS00002UR	Global	Fastening to steel, Fastening to steel for shipbuilding
	ICC-ES ESR-1663	USA	Fastening to steel and concrete
	ITB AT-15-7235/2015	Poland	Fastening to steel and concrete
	LR 97/00077(E4)	Global	Fastening to steel
E-Fastener	ETA-16/0301	Europe	Cable fastening
	„Rom. Ministry, ICECON: AT 003-05/500-2016,„	Romania	Cable and conduit fastening
NPH2	BUtgb ATG 1824	Belgium	Metal deck fastening
	Socotec N 1601601R0000004	France	Deck fastening
	ITB-KOT-2019-0799	Poland	Fastening to steel and concrete

Product	Approval	Country	Application
S-BT	ABS 16-HS1550085-2-PDA	Global	Fastening to steel, Fastening to steel for off-shore applications, Fastening to steel for shipbuilding
	BV 45116/A2 BV	Global	Fastening to steel, Fastening to steel for shipbuilding
	DNV-GL TAS00000N6	Global	Fastening to steel, Fastening to steel for off-shore applications, Fastening to steel for shipbuilding
	ETA-20/0530	Global	Fastening to steel
	ITB AT-15-7696/2016	Poland	Fastening to steel and concrete
	ITB-KOT-2019-0799	Poland	Fastening to steel and concrete
	LR 16/00063(E1)	Global	Fastening to steel, Fastening to steel for off-shore applications, Fastening to steel for shipbuilding
	Russian Maritime Register	Global	Fastening to steel, Fastening to steel for shipbuilding
S-BT-ER / -EF (HC)	RINA FPE278318CS	Global	Fastening to steel, Fastening to steel for off-shore applications, Fastening to steel for shipbuilding
	ABS 16-HS1550085-2-PDA	Global	Fastening to steel, Fastening to steel for off-shore applications, Fastening to steel for shipbuilding
	BV 45116/A2 BV	Global	Fastening to steel, Fastening to steel for shipbuilding
	DNV-GL TAS00000N6	Global	Fastening to steel, Fastening to steel for off-shore applications, Fastening to steel for shipbuilding
	Russian Maritime Register	Global	Fastening to steel, Fastening to steel for shipbuilding
RINA FPE278318CS	Global	Fastening to steel, Fastening to steel for off-shore applications, Fastening to steel for shipbuilding	

Product	Approval	Country	Application
W10	FM Sprinkler Piper Listings	USA	Sprinkler pipe fastening
	ICC-ES ESR-1663	USA	Fastening to steel and concrete
	UL EX 2258	USA	Sprinkler pipe fastening
	UL EX 2258	Canada	Sprinkler pipe fastening
W6	ICC-ES ESR-1663	USA	Fastening to steel and concrete
Wood nails	BRANZ Appraisal 780 (2012)	New Zealand	Timber joints fastening
X-BT	ABS 16-HS1545448-PDA	Global	Fastening to steel, Fastening to steel for off-shore applications, Fastening to steel for shipbuilding
	BV 23498/B0	Global	Fastening to steel, Fastening to steel for shipbuilding
	Canadian Navy	Canada	Fastening to steel, Fastening to steel for shipbuilding
	DNV-GL 12272-10HH	Global	Fastening to steel, Fastening to steel for off-shore applications, Fastening to steel for shipbuilding
	DNV-GL TAS00001SV	Global	Fastening to steel, Fastening to steel for off-shore applications, Fastening to steel for shipbuilding
	ICC-ES ESR-2347 (rev. 09/2018)	USA	Fastening to steel
	ITB AT-15-7696/2016	Poland	Fastening to steel and concrete
	LR 03/00070(E4)	Global	Fastening to steel, Fastening to steel for off-shore applications, Fastening to steel for shipbuilding
	LR 19/00003-02	Global	Fastening to steel
	UL E257069	Canada	Grounding
	UL E257069	USA	Grounding
	U.S. Navy 61/09-220	USA	Fastening to steel, Fastening to steel for shipbuilding

Product	Approval	Country	Application
X-BT-ER	ABS 18-HS1755518-PDA	Global	Fastening to steel, Fastening to steel for off-shore applications, Fastening to steel for shipbuilding
	BV 54054/A0 BV	Global	Fastening to steel, Fastening to steel for shipbuilding
	DNV-GL TAS00001SV	Global	Fastening to steel, Fastening to steel for off-shore applications, Fastening to steel for shipbuilding
	LR 19/00003-02	Global	Fastening to steel
	„Rom. Ministry, ICECON: AT 016-01_417-2019“	Russia	Fastening to steel
	Russian Maritime Register No. 20.40088.250	Global	Fastening to steel, Fastening to steel for shipbuilding
X-BT-GR	ABS 18-HS1755518-PDA	Global	Fastening to steel, Fastening to steel for off-shore applications, Fastening to steel for shipbuilding
	BV 54054/A0 BV	Global	Fastening to steel, Fastening to steel for shipbuilding
	DNV-GL TAS00001SV	Global	Fastening to steel, Fastening to steel for off-shore applications, Fastening to steel for shipbuilding
	ETA-20/1042	Global	Fastening to steel
	LR 19/00003-02	Global	Fastening to steel
	„Rom. Ministry, ICECON: AT 016-01_417-2019“	Russia	Fastening to steel
	Russian Maritime Register No. 20.40088.250	Global	Fastening to steel, Fastening to steel for shipbuilding

Product	Approval	Country	Application
X-BT-MF	ICC ESR 2347	USA	Fastening to steel
X-BT-MR	ABS 18-HS1755518-PDA	Global	Fastening to steel, Fastening to steel for off-shore applications, Fastening to steel for shipbuilding
	BV 54054/A0 BV	Global	Fastening to steel, Fastening to steel for shipbuilding
	DNV-GL TAS00001SV	Global	Fastening to steel, Fastening to steel for off-shore applications, Fastening to steel for shipbuilding
	ETA-20/1042	Global	Fastening to steel
	LR 19/00003-02	Global	Fastening to steel
	„Rom. Ministry, ICECON: AT 016-01_417-2019“	Russia	Fastening to steel
X-BT-MR-N M8	Russian Maritime Register No. 20.40088.250	Global	Fastening to steel, Fastening to steel for shipbuilding
	ABS 16-HS1545448-PDA	Global	Fastening to steel, Fastening to steel for off-shore applications, Fastening to steel for shipbuilding
X-BX	LR 03/00070(E4)	Global	Fastening to steel, Fastening to steel for off-shore applications, Fastening to steel for shipbuilding
	UL E217969	USA	Pipe and ventilation duct fastening
	UL E217969	Canada	Pipe and ventilation duct fastening

Product	Approval	Country	Application
X-C	IBMB 4850-2018	Germany	Fastening drywall track
	IBMB 4850-2018	Germany	Fastening drywall track
	IBMB 4708/2014	Germany	Fastening drywall track
	IBMB 6536/8173	Germany	Fastening drywall track
	IBMB 6537/8174	Germany	Fastening drywall track
	ICC-ES ESR-1663	USA	Fastening to steel and concrete
	ICC-ES ESR-1752	USA	Fastening to steel and concrete
	ITB AT-15-7696/2016	Poland	Fastening to steel and concrete
	„Rom. Ministry, ICECON: AT 016-01/420-2020“	Romania	Fastening to concrete
X-C B3	IBMB 8300-2016	Germany	Fastening drywall track
	IBMB 8302-2016	Germany	Fastening drywall track
	IBMB 8304-2016	Germany	Fastening drywall track
	ICC-ES ESR-1752	USA	Fastening to steel and concrete
	ITB AT-15-7235/2015	Poland	Fastening to steel and concrete
	ITB-KOT-2019-0799	Poland	Fastening to steel and concrete
X-C G2	ICC-ES ESR-1752	USA	Fastening to steel and concrete
	ITB AT-15-7235/2015	Poland	Fastening to steel and concrete
X-C G3	ICC-ES ESR-1752	USA	Fastening to steel and concrete
	ITB AT-15-7235/2015	Poland	Fastening to steel and concrete
	ITB-KOT-2019-0799	Poland	Fastening to steel and concrete
	„Rom. Ministry, ICECON: AT 016-01_373-2017“	Romania	Fastening to steel and concrete
X-CC	CSTB AT 3/16-844	France	Cable and conduit fastening
	ITB AT-15-7696/2016	Poland	Fastening to steel and concrete
	ITB-KOT-2019-0799	Poland	Fastening to steel and concrete
	LR 97/00077(E4)	Global	Fastening to steel
	„Rom. Ministry, ICECON: AT 016-01/420-2020“	Romania	Fastening to concrete

Product	Approval	Country	Application
X-CF72	ICC-ES ESR-2379	USA	Sill plate fastening
X-CP72	ICC-ES ESR-2379	USA	Sill plate fastening
X-CR	ABS 16-HS1545447-PDA	Global	Fastening to steel
	IBMB 3041/8171	Germany	Fastening drywall track
	ICC-ES ESR-1663	USA	Fastening to steel and concrete
	ITB AT-15-7235/2015	Poland	Fastening to steel and concrete
	LR 97/00078(E4)	Global	Fastening to steel, Fastening to steel for off-shore applications, Fastening to steel for shipbuilding
	„Rom. Ministry, ICECON: AT 016-01/420-2020“	Romania	Fastening to concrete
X-CR 48 (DX-Kwik)	ETA-14/0426	Europe	Fastening to concrete
X-CR 52 (DX-Kwik)	ETA-14/0426	Europe	Fastening to concrete
X-CR M8	DIBt Z-21.7-1512	Germany	Facade fastening
	DIBt Z-21.7-670	Germany	Suspended ceiling fastening
	ICC-ES ESR-2347	USA	Fastening to steel
	ITB AT-15-7235/2015	Poland	Fastening to steel and concrete
	ITB AT-15-7696/2016	Poland	Fastening to steel and concrete
X-CT	ITB AT-15-7696/2016	Poland	Fastening to steel and concrete
X-CX ALH	ICC-ES ESR-2184	USA	Suspended ceiling fastening
X-CX C27	ICC-ES ESR-2184	USA	Suspended ceiling fastening
X-DFB	ITB AT-15-7696/2016	Poland	Fastening to steel and concrete
X-DKH	IBMB 3041/8171	Germany	Fastening drywall track
	ITB AT-15-7696/2016	Poland	Fastening to steel and concrete
X-DKH48 (DX-Kwik)	DIBt Z-21.7-670	Germany	Suspended ceiling fastening
X-DR ALH	ICC-ES ESR-2795	USA	Ceiling hanger fastening
X-DR MX	ICC-ES ESR-2795	USA	Ceiling hanger fastening

Product	Approval	Country	Application
X-ECC MX	ETA-16/0301	Europe	Cable and conduit fastening
	ITB AT-15-7696/2016	Poland	Fastening to steel and concrete
	ITB-KOT-2019-0799	Poland	Fastening to steel and concrete
X-ECH MX	ETA-16/0301	Europe	Cable and conduit fastening
X-ECH	CSTB AT 3/16-844	France	Cable and conduit fastening
	ITB AT-15-7696/2016	Poland	Fastening to steel and concrete
X-ECH/FR-L/-M/-S with X-U37	UL E201485	USA	Cable and conduit fastening
	UL E201485	Canada	Cable and conduit fastening
X-ECH-FE MX	abP P-MPA-E-16-010	Germany	Circuit integrity fastening
	abP P-2401/198/16-MPA-BS	Germany	Circuit integrity fastening
	abP P-1023 DMT DO	Germany	Circuit integrity fastening
X-ECT	CSTB AT 3/16-844	France	Cable and conduit fastening
	ITB AT-15-7235/2015	Poland	Fastening to steel and concrete
X-ECT MX	UL E201485	USA	Cable and conduit fastening
	ETA-16/0301	Europe	Cable and conduit fastening
	UL E201485	Canada	Cable and conduit fastening
X-EF	ABS 16-HS1545445-PDA	Global	Fastening to steel
	LR 97/00077(E4)	Global	Fastening to steel
X-EGN	IBMB 4708/2014	Germany	Fastening drywall track
	IBMB 6536/8173	Germany	Fastening drywall track
	IBMB 6537/8174	Germany	Fastening drywall track
	ICC-ES ESR-1752	USA	Fastening to steel and concrete
	ITB AT-15-7235/2015	Poland	Fastening to steel and concrete
	„Rom. Ministry, ICECON: AT 016-01_388-2018“	Romania	Fastening to steel and concrete

Product	Approval	Country	Application
X-EHS MX	ETA-16/0301	Europe	Cable and conduit fastening
	ITB AT-15-7696/2016	Poland	Fastening to steel and concrete
	ITB-KOT-2019-0799	Poland	Fastening to steel and concrete
X-EKB	CSTB AT 3/16-844	France	Cable and conduit fastening
	ETA-16/0301	Europe	Cable and conduit fastening
	ITB AT-15-7696/2016	Poland	Fastening to steel and concrete
X-EKB MX	UL E201485	USA	Cable and conduit fastening
	ETA-16/0301	Europe	Cable and conduit fastening
	UL E201485	Canada	Cable and conduit fastening
X-EKB-FE MX	abP P-MPA-E-16-010	Germany	Circuit integrity fastening
	abP P-2401/198/16-MPA-BS	Germany	Circuit integrity fastening
	abP P-1023 DMT DO	Germany	Circuit integrity fastening
X-EKS MX	ETA-16/0301	Europe	Cable and conduit fastening
	CSTB AT 3/16-844	France	Cable and conduit fastening
X-EKSC MX	ITB AT-15-7235/2015	Poland	Fastening to steel and concrete
	UL E201485	USA	Cable and conduit fastening
	UL E201485	Canada	Cable and conduit fastening
	ETA-16/0301	Europe	Cable and conduit fastening
X-EM	ABS 16-HS1545445-PDA	Global	Fastening to steel
	LR 97/00077(E4)	Global	Fastening to steel
X-EM6/8/10H	ITB AT-15-7235/2015	Poland	Fastening to steel and concrete
X-EMH	„Rom. Ministry, ICECON: AT 016-01/420-2020“	Romania	Fastening to concrete
X-EMTSC	UL E217969	USA	Pipe and ventilation duct fastening
	UL E217969	Canada	Pipe and ventilation duct fastening

Product	Approval	Country	Application
X-ENK	ITB AT-15-7235/2015	Poland	Fastening to steel and concrete
X-ENP	FM 3054498	USA	Deck fastening
X-ENP-19	ABS 16-HS1545445-PDA	Global	Fastening to steel
	DIN EN 1993-1-3/NA	Germany	Deck fastening
	ETA-04/0101	Europe	Deck fastening
	FM 3029102	USA	Form deck fastening
	IAPMO ER 2018, Verco Co-listing	USA	Deck fastening
	IAPMO ER 161, ASC Co-listing	USA	Deck fastening
	ICC-ES ESR-1663	USA	Deck fastening
	ICC-ES ESR-2197	USA	Deck fastening
	ICC-ES ESR-2776	USA	Deck fastening
	LR 97/00077(E4)	Global	Fastening to steel
	MLIT 2005	Japan	Deck fastening
	SDI	USA	Deck fastening
UL R 13203	USA	Deck fastening	
X-ENP2K	ABS 16-HS1545445-PDA	Global	Fastening to steel
	BUtgb ATG 1824	Belgium	Metal Deck fastening
	ETA-13/0172	Europe	Deck fastening
	ITB AT-15-7696/2016	Poland	Fastening to steel and concrete
	LR 97/00077(E4)	Global	Fastening to steel
	„Rom. Ministry, ICECON: AT 016-01/420-2020“	Romania	Fastening to concrete
X-ET	ITB AT-15-7696/2016	Poland	Fastening to concrete and steel
X-EW	ABS 16-HS1545445-PDA	Global	Fastening to steel
	LR 97/00077(E4)	Global	Fastening to steel
X-EW10	FM Sprinkler Piper Listings	USA	Sprinkler pipe fastening
	UL EX 2258	USA	Sprinkler pipe fastening
	UL EX 2258	Canada	Sprinkler pipe fastening
	UL EX 2258	Canada	Sprinkler pipe fastening

Product	Approval	Country	Application
X-EW10H	FM 3026695	USA	Fastening to steel
	ICC-ES ESR-2347	USA	Fastening to steel
	UL EX 2258	USA	Sprinkler pipe fastening
	UL EX 2258	Canada	Sprinkler pipe fastening
X-EW6H	FM 3026695	USA	Fastening to steel
	ICC-ES ESR-2347	USA	Fastening to steel
	UL EX 2258	USA	Sprinkler pipe fastening
	UL EX 2258	Canada	Sprinkler pipe fastening
X-FB	ITB AT-15-7696/2016	Poland	Fastening to steel and concrete
X-FB MX	ETA-16/0301	Europe	Cable and conduit fastening
X-FCM	ABS 15-HS1456396-3-PDA	Global	Fastening to steel, Fastening to steel for off-shore applications, Fastening to steel for shipbuilding
	ABS 16-HS1545445-PDA	Global	Fastening to steel
	ABS 18-HS1785836-PDA	Global	Fastening to steel, Fastening to steel for off-shore applications, Fastening to steel for shipbuilding
	DNV-GL TAS00001UJ	Global	Fastening to steel, Fastening to steel for off-shore applications, Fastening to steel for shipbuilding
	ITB AT-15-7235/2015	Poland	Fastening to steel and concrete
	LR 97/00077(E4)	Global	Fastening to steel
	„Rom. Ministry, ICECON: AT 016-01/420-2020“	Romania	Fastening to concrete

Product	Approval	Country	Application
X-FCM-M	ABS 15-HS1456396-3-PDA	Global	Fastening to steel, Fastening to steel for off-shore applications, Fastening to steel for shipbuilding
	ABS 16-HS1545447-PDA	Global	Fastening to steel
	ABS 16-HS1545448-PDA	Global	Fastening to steel, Fastening to steel for off-shore applications, Fastening to steel for shipbuilding
	ABS 16-HS1550085-2-PDA	Global	Fastening to steel, Fastening to steel for off-shore applications, Fastening to steel for shipbuilding
	BV 23498/B0	Global	Fastening to steel, Fastening to steel for shipbuilding
	BV 45116/A2 BV	Global	Fastening to steel, Fastening to steel for shipbuilding
	DNV-GL 12272-10HH	Global	Fastening to steel, Fastening to steel for off-shore applications, Fastening to steel for shipbuilding
	DNV-GL TAS00000N6	Global	Fastening to steel, Fastening to steel for off-shore applications, Fastening to steel for shipbuilding
	RINA FPE278318CS	Global	Fastening to steel, Fastening to steel for off-shore applications, Fastening to steel for shipbuilding
	Russian Maritime Register No. 20.40088.250	Global	Fastening to steel, Fastening to steel for shipbuilding

Product	Approval	Country	Application
X-FCM-R	ABS 15-HS1456396-3-PDA	Global	Fastening to steel, Fastening to steel for off-shore applications, Fastening to steel for shipbuilding
	ABS 16-HS1545447-PDA	Global	Fastening to steel
	ABS 16-HS1545448-PDA	Global	Fastening to steel, Fastening to steel for off-shore applications, Fastening to steel for shipbuilding
	ABS 16-HS1550085-2-PDA	Global	Fastening to steel, Fastening to steel for off-shore applications, Fastening to steel for shipbuilding
	BV 23498/B0	Global	Fastening to steel, Fastening to steel for shipbuilding
	BV 45116/A2 BV	Global	Fastening to steel, Fastening to steel for shipbuilding
	DNV-GL 12272-10HH	Global	Fastening to steel, Fastening to steel for off-shore applications, Fastening to steel for shipbuilding
	DNV-GL TAS00000N6	Global	Fastening to steel, Fastening to steel for off-shore applications, Fastening to steel for shipbuilding
	LR 03/00070(E4)	Global	Fastening to steel, Fastening to steel for off-shore applications, Fastening to steel for shipbuilding
	LR 97/00078(E4)	Global	Fastening to steel, Fastening to steel for off-shore applications, Fastening to steel for shipbuilding
	LR 19/00003-02	Global	Fastening to steel
	Russian Maritime Register No. 20.40088.250	Global	Fastening to steel, Fastening to steel for shipbuilding
RINA FPE278318CS	Global	Fastening to steel, Fastening to steel for off-shore applications, Fastening to steel for shipbuilding	

Product	Approval	Country	Application
X-FCM-R HL	ABS 18-HS1785836-PDA	Global	Fastening to steel, Fastening to steel for off-shore applications, Fastening to steel for shipbuilding
	BV 54054/A0 BV	Global	Fastening to steel, Fastening to steel for shipbuilding
	Russian Maritime Register No. 20.40088.250	Global	Fastening to steel, Fastening to steel for shipbuilding
X-FCP-F	ABS 15-HS1456396-3-PDA	Global	Fastening to steel, Fastening to steel for off-shore applications, Fastening to steel for shipbuilding
	ABS 16-HS1545447-PDA	Global	Fastening to steel
	ABS 18-HS1785836-PDA	Global	Fastening to steel, Fastening to steel for off-shore applications, Fastening to steel for shipbuilding
	ITB AT-15-7235/2015	Poland	Fastening to steel and concrete
	LR 97/00077(E4)	Global	Fastening to steel
X-FCP-R	ABS 15-HS1456396-3-PDA	Global	Fastening to steel, Fastening to steel for off-shore applications, Fastening to steel for shipbuilding
	ABS 16-HS1545447-PDA	Global	Fastening to steel
	ABS 18-HS1785836-PDA	Global	Fastening to steel, Fastening to steel for off-shore applications, Fastening to steel for shipbuilding
	ITB AT-15-7235/2015	Poland	Fastening to steel and concrete
	LR 97/00077(E4)	Global	Fastening to steel
	LR 97/00078(E4)	Global	Fastening to steel, Fastening to steel for off-shore applications, Fastening to steel for shipbuilding

Product	Approval	Country	Application
X-FCS	ABS 18-HS1755527-PDA	Global	Fastening to steel, Fastening to steel for off-shore applications, Fastening to steel for shipbuilding
	BV 54054/A0 BV	Global	Fastening to steel, Fastening to steel for shipbuilding
	DNV-GL TAS00001UJ	Global	Fastening to steel, Fastening to steel for off-shore applications, Fastening to steel for shipbuilding
	LR 03/00070(E4)	Global	Fastening to steel, Fastening to steel for off-shore applications, Fastening to steel for shipbuilding
	LR 19/00003-02	Global	Fastening to steel
	RINA FPE278318CS	Global	Fastening to steel, Fastening to steel for off-shore applications, Fastening to steel for shipbuilding
X-FS	ITB AT-15-7696/2016	Poland	Fastening to steel and concrete
	„Rom. Ministry, ICECON: AT 016-01/420-2020“	Romania	Fastening to concrete
X-G	ITB AT-15-7696/2016	Poland	Fastening to steel and concrete
X-GHP	IBMB 4850-2018	Germany	Fastening drywall track
	IBMB 4850-2018	Germany	Fastening drywall track
	ICC-ES ESR-1752	USA	Fastening to steel and concrete
	„Rom. Ministry, ICECON: AT 016-01_388-2018“	Romania	Fastening to steel and concrete

Product	Approval	Country	Application
X-GN	IBMB 4850-2018	Germany	Fastening drywall track
	IBMB 4850-2018	Germany	Fastening drywall track
	IBMB 4708/2014	Germany	Fastening drywall track
	IBMB 6536/8173	Germany	Fastening drywall track
	IBMB 6537/8174	Germany	Fastening drywall track
	ICC-ES ESR-1752	USA	Fastening to steel and concrete
	ITB AT-15-7235/2015	Poland	Fastening to steel and concrete
	„Rom. Ministry, ICECON: AT 016-01_388-2018“	Romania	Fastening to steel and concrete
X-GR	ITB AT-15-7696/2016	Poland	Fastening to steel and concrete
X-HS	CSTB AT 3/16-844	France	Cable and conduit fastening
	ITB AT-15-7696/2016	Poland	Fastening to steel and concrete
	ITB-KOT-2019-0799	Poland	Fastening to steel and concrete
	LR 97/00077(E4)	Global	Fastening to steel
	„Rom. Ministry, ICECON: AT 016-01/420-2020“	Romania	Fastening to concrete
X-HS U19	ICC-ES ESR-2795	USA	Ceiling hanger fastening
X-HS U32	ICC-ES ESR-2795	USA	Ceiling hanger fastening
X-HS W6/10 U19	FM 3031301	USA	Sprinkler pipe fastening
X-HS W6/10 U19/22/27	UL E217969	USA	Pipe and ventilation duct fastening
	UL E217969	Canada	Pipe and ventilation duct fastening
X-HSN 24	ABS 16-HS1545445-PDA	Global	Fastening to steel
	FM 3054498	USA	Deck fastening
	IAPMO ER 2018, Verco Co-listing	USA	Deck fastening
	IAPMO ER 161, ASC Co-listing	USA	Deck fastening
	ICC-ES ESR-1169	USA	Deck fastening
	ICC-ES ESR-2197	USA	Deck fastening
	ICC-ES ESR-2776	USA	Deck fastening
	SDI	USA	Deck fastening
	UL R 13203	USA	Deck fastening

Product	Approval	Country	Application
X-HS-W	CSTB AT 3/16-844	France	Cable and conduit fastening
	ITB AT-15-7696/2016	Poland	Fastening to steel and concrete
X-HVB	ETA-15/0876	Europe	Composite shear connection
X-IE	ITB AT-15-7235/2015	Poland	Fastening to steel and concrete
	ITB AT-15-7696/2016	Poland	Fastening to steel and concrete
	ITB-KOT-2019-0799	Poland	Fastening to steel and concrete
	Socotec N 1601601R0000003	France	Insulation fastening
	Russian Ministry/FCS TS/TO 5851-19	Russia	Insulation fastening
X-IE-G	Socotec N 180668080000010	France	Insulation fastening
XI-FV	ETA-17/0304	Europe	Insulation fastening (ETICS)
X-M10	ITB AT-15-7235/2015	Poland	Fastening to steel and concrete
X-M6	„Rom. Ministry, ICECON: AT 016-01/420-2020“	Romania	Fastening to concrete
X-M6 B3	ITB AT-15-7235/2015	Poland	Fastening to steel and concrete
X-M6 G2	ITB AT-15-7235/2015	Poland	Fastening to steel and concrete
X-M6 G3	„Rom. Ministry, ICECON: AT 016-01_373-2017“	Romania	Fastening to steel and concrete
	ITB AT-15-7235/2015	Poland	Fastening to steel and concrete
X-M6H	IBMB 3041/8171	Germany	Fastening drywall track
	ITB AT-15-7696/2016	Poland	Fastening to steel and concrete
X-M8	ITB AT-15-7235/2015	Poland	Fastening to steel and concrete
X-M8H	DIBt Z-21.7-670	Germany	Suspended ceiling fastening
	IBMB 3041/8171	Germany	Fastening drywall track
	ITB AT-15-7235/2015	Poland	Fastening to steel and concrete
	ITB AT-15-7696/2016	Poland	Fastening to steel and concrete

Product	Approval	Country	Application
X-MGR	ITB AT-15-7696/2016	Poland	Fastening to steel and concrete
X-NK	ITB AT-15-7235/2015	Poland	Fastening to steel and concrete
X-P	IBMB 19210-2017	Germany	Fastening drywall track
	IBMB 19211-2017	Germany	Fastening drywall track
	IBMB 19212-2017	Germany	Fastening drywall track
	ICC-ES ESR-2269	USA	Fastening to steel and concrete
	ITB-KOT-2019-0799	Poland	Fastening to steel and concrete
	„Rom. Ministry, ICECON: AT 016-01/420-2020“	Romania	Fastening to concrete
	VHT PZ-633-20	Germany	Fastening drywall track
	VHT PZ-809-15	Germany	Deflection head fastening
X-P B3	IBMB 8300-2016	Germany	Fastening drywall track
	IBMB 8302-2016	Germany	Fastening drywall track
	IBMB 8304-2016	Germany	Fastening drywall track
	ETA-16/0301	Europe	Cable and conduit fastening
	ICC-ES ESR-1752	USA	Fastening to steel and concrete
	ITB AT-15-7235/2015	Poland	Fastening to steel and concrete
X-P G2	ICC-ES ESR-1752	USA	Fastening to steel and concrete
	ITB AT-15-7235/2015	Poland	Fastening to steel and concrete
X-P G3	ICC-ES ESR-1752	USA	Fastening to steel and concrete
	ETA-16/0301	Europe	Cable and conduit fastening
	ITB AT-15-7235/2015	Poland	Fastening to steel and concrete
	ITB-KOT-2019-0799	Poland	Fastening to steel and concrete
	„Rom. Ministry, ICECON: AT 016-01_373-2017“	Romania	Fastening to steel and concrete
X-PGR	ITB AT-15-7696/2016	Poland	Fastening to steel and concrete

Product	Approval	Country	Application
X-PN	ICC-ES ESR-3059	USA	Plywood fastening
	ITB AT-15-7696/2016	Poland	Fastening to steel and concrete
X-PN 37 G2	ICC-ES ESR-3059	USA	Plywood fastening
X-PN 37 G3	ICC-ES ESR-3059	USA	Plywood fastening
X-PN G3	ITB-KOT-2019-0799	Poland	Fastening to steel and concrete
X-R	ABS 16-HS1545447-PDA	Global	Fastening to steel
	DIBt Z-14.4-766	Germany	Glas facade fastening
	ITB AT-15-7235/2015	Poland	Fastening to steel and concrete
	LR 97/00078(E4)	Global	Fastening to steel, Fastening to steel for off-shore applications, Fastening to steel for shipbuilding
	ICC-ES ESR-1663	USA	Fastening to steel and concrete
X-S	ICC-ES ESR-1752	USA	Fastening to steel and concrete
	ITB AT-15-7235/2015	Poland	Fastening to steel and concrete
X-S B3	ICC-ES ESR-1752	USA	Fastening to steel and concrete
X-S G3	ICC-ES ESR-1752	USA	Fastening to steel and concrete
	ITB-KOT-2019-0799	Poland	Fastening to steel and concrete
	„Rom. Ministry, ICECON: AT 016-01_373-2017“	Romania	Fastening to steel and concrete
X-ST-GR	ABS 16-HS1545447-PDA	Global	Fastening to steel
	ICC-ES ESR-2347	USA	Fastening to steel
	ITB AT-15-7235/2015	Poland	Fastening to steel and concrete
	LR 97/00078(E4)	Global	Fastening to steel, Fastening to steel for off-shore applications, Fastening to steel for shipbuilding
X-SW	ITB AT-15-7696/2016	Poland	Fastening to steel and concrete
	„Rom. Ministry, ICECON: AT 016-01/420-2020“	Romania	Fastening to concrete

Product	Approval	Country	Application
X-U	ABS 16-HS1545445-PDA	Global	Fastening to steel
	DIBt Z-14.4-517	Germany	Fastening to steel
	DNV-GL TAS00002UR	Global	Fastening to steel, Fastening to steel for shipbuilding
	IBMB 2006/2011	Germany	Fastening drywall track
	IBMB 4708/2014	Germany	Fastening drywall track
	IBMB 6536/8173	Germany	Fastening drywall track
	IBMB 6537/8174	Germany	Fastening drywall track
	ICC-ES ESR-2269	USA	Fastening to steel and concrete
	ITB AT-15-7696/2016	Poland	Fastening to steel and concrete
	ITB-KOT-2019-0799	Poland	Fastening to steel and concrete
	LR 97/00077(E4)	Global	Fastening to steel
	„Rom. Ministry, ICECON: AT 016-01/420-2020“	Romania	Fastening to concrete
	VHT PZ-633-20	Germany	Fastening drywall track
	VHT PZ-809-15	Germany	Fastening drywall track
X-U15	ICC-ES ESR-2269	USA	Fastening to steel and concrete
X-U16 S12	ETA-16/0082	Europe	Siding
X-UCT	ITB AT-15-7235/2015	Poland	Fastening to steel and concrete
X-W6	ICC-ES ESR-1663	USA	Fastening to steel and concrete
X-X1	ETA-19/0439	Europe	Insulation fastening (ETICS)

Approvals → Nails

Approval	Product	Country	Application
abP P-MPA-E-16-010	X-ECH-FE MX, X-EKB-FE MX	Germany	Circuit integrity fastening
abP P-2401/198/16-MPA-BS	X-ECH-FE MX, X-EKB-FE MX	Germany	Circuit integrity fastening
abP P-1023 DMT DO	X-ECH-FE MX, X-EKB-FE MX	Germany	Circuit integrity fastening
ABS 15-HS1456396-3-PDA	X-FCM, X-FCM-R, X-FCM-M, X-FCP-R, X-FCP-F	Global	Fastening to steel, Fastening to steel for off-shore applications, Fastening to steel for shipbuilding
ABS 16-HS1545445-PDA	EDS, X-U, X-ENP2K, X-ENP-19, X-HSN 24, X-EM, X-EW, X-EF, X-FCM	Global	Fastening to steel
ABS 16-HS1545447-PDA	X-CR, X-R14, X-CRM, X-CRW, X-ST-GR, X-FCM-R, X-FCM-M, X-FCP-R, X-FCP-F	Global	Fastening to steel
ABS 16-HS1545448-PDA	X-BT, X-BT-ER, X-BT-MR-N M8, X-FCM-M, X-FCM-R	Global	Fastening to steel, Fastening to steel for off-shore applications, Fastening to steel for shipbuilding
ABS 16-HS1550085-2-PDA	S-BT, S-BT-ER / -EF (HC), X-FCM-M, X-FCM-R	Global	Fastening to steel, Fastening to steel for off-shore applications, Fastening to steel for shipbuilding
ABS 18-HS1755518-PDA	X-BT-MR, X-BT-GR, X-BT-ER	Global	Fastening to steel, Fastening to steel for off-shore applications, Fastening to steel for shipbuilding
ABS 18-HS1785836-PDA	X-FCM-R HL, X-FCM, X-FCP-R, X-FCP-F	Global	Fastening to steel, Fastening to steel for off-shore applications, Fastening to steel for shipbuilding
ABS 18-HS1755527-PDA	X-FCS	Global	Fastening to steel, Fastening to steel for off-shore applications, Fastening to steel for shipbuilding
BRANZ Appraisal 780 (2012)	Wood nails	New Zealand	Timber joints fastening

Approval	Product	Country	Application
BUtgb ATG 1824	NPH2, X-ENP2K	Belgium	Metal deck fastening
BV 23498/B0	X-BT, X-FCM-M, X-FCM-R	Global	Fastening to steel, Fastening to steel for shipbuilding
BV 45116/A2 BV	S-BT, S-BT-ER / -EF (HC), X-FCM-M, X-FCM-R	Global	Fastening to steel, Fastening to steel for shipbuilding
BV 54054/A0 BV	X-BT-MR, X-BT-GR, X-BT-ER, X-FCS, X-FCM-R HL	Global	Fastening to steel, Fastening to steel for shipbuilding
Canadian Navy	X-BT	Canada	Fastening to steel, Fastening to steel for shipbuilding
CNBOP-PIB-KOT-2019/ 0096-3703 wydanie 3	E-Fasteners	Poland	Cable and conduit fastening
CSTB AT 3/16-844	X-EKB, X-ECH, X-ECT, X-EKS, X-EKSC, X-CC, X-HS, X-HS-W	France	Cable and conduit fastening
DIBt Z-14.4-517	X-U	Germany	Fastening to steel
DIBt Z-14.4-766	X-R14	Germany	Glas facade fastening
DIBt Z-21.7-1512	X-CR M8, X-CR 48	Germany	Facade fastening
DIBt Z-21.7-670	X-M8H, X-CR M8, X-DKH48 (DX-Kwik)	Germany	Suspended ceiling fastening
DIN EN 1993-1-3/NA	X-ENP-19 Lateral buckling	Germany	Deck fastening
DNV-GL 12272-10HH	X-BT, X-BT-ER, X-FCM-M, X-FCM-R	Global	Fastening to steel, Fastening to steel for off-shore applications, Fastening to steel for shipbuilding
DNV-GL TAS00002UR	X-U, EDS	Global	Fastening to steel, Fastening to steel for shipbuilding
DNV-GL TAS00000N6	S-BT, S-BT-ER / -EF (HC), X-FCM-M, X-FCM-R	Global	Fastening to steel, Fastening to steel for off-shore applications, Fastening to steel for shipbuilding
DNV-GL TAS00001SV	X-BT-GR, X-BT-MR, X-BT-ER	Global	Fastening to steel, Fastening to steel for off-shore applications, Fastening to steel for shipbuilding

Approval	Product	Country	Application
DNV-GL TAS00001UJ	X-FCM, X-FCS	Global	Fastening to steel, Fastening to steel for off-shore applications, Fastening to steel for shipbuilding
ETA-04/0101	X-ENP-19	Europe	Deck fastening
ETA-13/0172	X-ENP2K, DX 76 PTR	Europe	Deck fastening
ETA-14/0426	X-CR 48 P8 S15 (DX-Kwik), X-CR 52 P8 S15 (DX-Kwik)	Europe	Fastening to concrete
ETA-15/0876	X-HVB	Europe	Composite shear connection
ETA-16/0082	X-U16 S12	Europe	Siding
ETA-16/0301	X-P 20 B3/G3, X-P 24 B3/G3, X-EKB MX, X-ECT MX, X-ECH MX, X-EKS MX, X-EKSC MX, X-(D)FB MX, X-ECC MX, X-EHS MX	Europe	Cable and conduit fastening
ETA-17/0304	XI-FV	Europe	Insulation fastening (ETICS)
ETA-19/0439	X-X1	Europe	Insulation fastening (ETICS)
ETA-20/0530	S-BT	Global	Fastening to steel
ETA-20/1042	X-BT-MR, X-BT-GR	Europe	Fastening to steel
FM 3026695	X-EW6H, X-EW10H	USA	Fastening to steel
FM 3029102	X-ENP-19	USA	Form deck fastening
FM 3031301	X-HS W6/10 U19	USA	Sprinkler pipe fastening
FM 3054498	X-ENP, X-HSN 24	USA	Deck fastening
FM Sprinkler pipe fastening Listings	W10, X-EW10	USA	Sprinkler pipe fastening
IAPMO ER 2018, Verco Co-listing	X-ENP-19, X-HSN 24	USA	Deck fastening
IAPMO ER 161, ASC Co-listing	X-EDN19, X-EDNK2, X-ENP-19, X-HSN 24	USA	Deck fastening
IBMB 4850-2018	X-GN, X-GHP, X-C	Germany	Fastening drywall track
IBMB 4850-2018	X-GN, X-GHP, X-C	Germany	Fastening drywall track
IBMB 2006/2011	X-U	Germany	Fastening drywall track
IBMB 3041/8171	DX-Kwik, X-CR, X-DKH, X-M6H, X-M8H	Germany	Fastening drywall track
IBMB 19210-2017	X-P, DX5, GX3, Knauf-Trockenbauwände	Germany	Fastening drywall track
IBMB 19211-2017	X-P, DX5, GX3, Siniat-Trockenbauwände	Germany	Fastening drywall track

Approval	Product	Country	Application
IBMB 19212-2017	X-P, DX5, GX3, Rigips-Trockenbauwände	Germany	Fastening drywall track
IBMB 8300-2016	X-P B3, X-C B3 Knauf-Trockenbauwände	Germany	Fastening drywall track
IBMB 8302-2016	X-P B3, X-C B3 Siniat-Trockenbauwände	Germany	Fastening drywall track
IBMB 8304-2016	X-P B3, X-C B3 Rigips-Trockenbauwände	Germany	Fastening drywall track
IBMB 4708/2014	X-GN, X-EGN, X-C, X-U, Rigips-Trockenbauwände	Germany	Fastening drywall track
IBMB 6536/8173	X-GN, X-EGN, X-C, X-U, Knauf-Trockenbauwände	Germany	Fastening drywall track
IBMB 6537/8174	X-GN, X-EGN, X-C, X-U, Siniat-Trockenbauwände	Germany	Fastening drywall track
IBMB Gutachten 1498/166/13	DX-Kwik X-HS	Germany	Ceiling hanger fastening
ICC-ES ESR-1663	X-ENP-19, EDS, DS, X-C, X-C22P8TH, X-C20THP, X-CR, X-W6, W10, X-R	USA	Fastening to steel and concrete
ICC-ES ESR-1752	X-GN, X-GHP, X-EGN, X-S, X-C, X-P G3, X-P G2, X-S G3, X-C G3, X-C G2, X-C B3, X-S B3, X-P B3	USA	Fastening to steel and concrete
ICC-ES ESR-2184	X-CX ALH, X-CX C27	USA	Suspended ceiling fastening
ICC-ES ESR-2197	X-ENP-19, X-HSN 24	USA	Deck fastening
ICC-ES ESR-2269	X-U, X-U15, X-P	USA	Fastening to steel and concrete
ICC-ES ESR-2347	X-EW6H, X-EW10H; X-CR M8, X-BT, X-ST-GR	USA	Fastening to steel
ICC-ES ESR-2379	X-CF72, X-CP72	USA	Sill plate fastening
ICC-ES ESR-2776	X-ENP-19, X-HSN 24	USA	Deck fastening
ICC-ES ESR-2795	X-HS U19, X-HS U32, X-DR ALH, X-DR MX	USA	Ceiling hanger fastening
ICC-ES ESR-3059	X-PN, X-PN 37 G2, X-PN 37 G3	USA	Plywood fastening

Approval	Product	Country	Application
ITB AT-15-7235/2015	X-CR, X-ENK, X-NK, X-CR M8, X-ECT, X-UCT, X-EKS, X-EKSC, DS, EDS, X-EGN, X-EM6/8/10H, X-FCM, X-IE, X-FCP-R, X-FCP-F, X-GN, X-M8, X-M10, X-M8H, X-P B3, X-P G3, X-P G2, X-C B3, X-C G3, X-C G2, X-M6 B3, X-M6 G3, X-M6 G2, X-S, X-ST-GR, X-R14	Poland	Fastening to steel and concrete
ITB AT-15-7696/2016	X-U, X-ENP2K, X-C, X-FS, X-SW, X-IE, X-CT, X-BT, X-GR, X-PGR, X-MGR, X-G, X-CR M8, X-HS, X-EHS, X-HS-W, X-CC, X-ECC, X-EKB, X-ECH, X-FB, X-DFB, X-M6H, X-M8H, DNH, X-DKH, X-PN, S-BT, X-ET	Poland	Fastening to steel and concrete
ITB-KOT-2019-0799	X-U, X-P, X-CC, X-HS, X-ECC, X-EHS, NPH2, X-IE, S-BT, X-C B3, X-P B3, X-C G3, X-P G3, X-PN G3	Poland	Fastening to steel and concrete
LR 03/00070(E4)	X-BT, X-BT-ER, X-BT- MR-N M8, X-FCM-R, X-FCS	Global	Fastening to steel, Fastening to steel for off-shore applications, Fastening to steel for shipbuilding
LR 97/00077(E4)	X-U, EDS, DS, X-ENP-19, X-ENP2K, X-EM, X-EW, X-EF, X-HS, X-CC, X-FCM, X-FCP-R, X-FCP-F	Global	Fastening to steel
LR 97/00078(E4)	X-CR, X-R14, X-CRM, X-ST-GR, X-FCM-R, X-FCP-R	Global	Fastening to steel, Fastening to steel for off-shore applications, Fastening to steel for shipbuilding
LR 16/00063(E1)	S-BT	Global	Fastening to steel, Fastening to steel for off-shore applications, Fastening to steel for shipbuilding
LR 19/00003-02	X-BT-GR, X-BT-MR, X-BT-ER, X-FCM-R, X-FCS	Global	Fastening to steel
MLIT 2005	X-ENP-19	Japan	Deck fastening

Approval	Product	Country	Application
RINA FPE278318CS	S-BT, S-BT-ER / -EF (HC), X-FCM-M, X-FCM-R, X-FCS	Global	Fastening to steel, Fastening to steel for off-shore applications and for shipbuilding
Rom. Ministry, ICECON: AT 003-05/500-2016	E-fasteners	Romania	Cable and conduit fastening
Rom. Ministry, ICECON: AT 003-05/720-2019	E-fasteners	Romania	Cable and conduit fastening
„Rom. Ministry, ICECON: AT 016-01_373-2017“	X-C G3, X-P G3, X-S G3, X-M6 G3	Romania	Fastening to steel and concrete
„Rom. Ministry, ICECON: AT 016-01_388-2018“	X-GN, X-EGN, X-GHP	Romania	Fastening to steel and concrete
„Rom. Ministry, ICECON: AT 016-01_389-2018“	DX-Kwik	Romania	Fastening to concrete
„Rom. Ministry, ICECON: AT 016-01_417-2019“	X-BT-MR, X-BT-GR, X-BT-ER, X-FCM-R HL	Russia	Fastening to steel
„Rom. Ministry, ICECON: AT 016-01/420-2020“	X-U, X-C, X-P, X-CR, X-CRM, X-M6, X-ENP2K, X-EMH, X-FCM, X-SW, X-FS, X-HS, X-CC, etc.	Romania	Fastening to concrete
„Rom. Ministry, ICECON: AT 016-01/435-2020“	X-C G3, X-P G3, X-S G3, X-M6 G3	Romania	Cable and conduit fastening
Russian Maritime Register	S-BT, S-BT-ER / -EF (HC), X-FCM-M, X-FCM-R	Global	Fastening to steel, Fastening to steel for shipbuilding
Russian Maritime Register No. 20.40088.250	X-BT-MR, X-BT-GR, X-BT-ER, X-FCM-R, X-FCM-R HL, X-FCM-M	Global	Fastening to steel, Fastening to steel for shipbuilding
Russian Ministry/FCS TS/TO 5851-19	X-IE	Russia	Insulation fastening
SDI	X-ENP-19, X-HSN 24	USA	Deck fastening
Socotec N 1601601R0000003	X-IE	France	Insulation fastening
Socotec N 1601601R0000004	NPH2	France	Deck fastening
Socotec N 180668080000010	X-IE-G	France	Insulation fastening
U.S. Navy 61/09-220	X-BT	USA	Fastening to steel, Fastening to steel for shipbuilding

Approval	Product	Country	Application
UL E257069	X-BT-M6, X-BT-W6, X-BT-M10-SN12-R, X-BT-W10-SN12-R, X-BT-R	Canada	Grounding
UL E201485	X-ECH/FR-L/-M/-S with X-U37, X-EKB MX, X-ECT MX, X-EKSC MX	USA	Cable and conduit fastening
UL E201485	X-ECH/FR-L/-M/-S with X-U37, X-EKB MX, X-ECT MX, X-EKSC MX	Canada	Cable and conduit fastening
UL E217969	X-HS W6/10 U19/22/27, X-RH, X-EMTSC, X-BX	USA	Pipe and ventilation duct fastening
UL E217969	X-HS W6/10 U19/22/27, X-RH, X-EMTSC, X-BX	Canada	Pipe and ventilation duct fastening
UL EX 2258	W10, X-EW10, X-EW6H, X-EW10H	USA	Sprinkler pipe fastening
UL EX 2258	W10, X-EW10, X-EW6H, X-EW10H	Canada	Sprinkler pipe fastening
UL R 13203	X-ENP-19, X-HSN 24	USA	Deck fastening
VHT PZ-633-20	X-U, X-P	Germany	Fastening drywall track
VHT PZ-809-15	X-U, X-P	Germany	Deflection head fastening



Hilti Corporation
9494 Schaan, Liechtenstein
P +423-234 2965

www.facebook.com/hiltigroup
www.hilti.group

April 2022 / 387113